

**SUZUKI**

**HATCH**

**WITH 550CC ENGINE**

**SERVICE MANUAL**

**SUZUKI**

*Caring for Customers*

99500-78110-24E

(英)

オーストラリア

# TABLE OF CONTENTS

GENERAL

## FOREWORD

This SERVICE MANUAL provides information on functional and construction details and sets forth the methods of inspecting, checking and servicing for this vehicle. The MANUAL is intended for use by technical personnel engaged in or related to the servicing work on these SUZUKI four-wheel vehicles.

So that the users of these SUZUKI machines will gain maximum benefits the machines are capable of giving and that each machine will serve best with the high performance built into it, it is hoped that this MANUAL will be looked up to as the source of necessary information by each SUZUKI serviceman.

The vehicle manufactured to standard specifications with right hand drive is the main subject matter of this Manual. However, the vehicle distributed in your country might differ in minor respects from the standard-specification and, if they do, it is because some minor modifications (which are of no consequence in most cases as far as servicing is concerned) had to be made to comply with the statutory requirements of your country.

This MANUAL came out of the first printing for this vehicle and does not cover modifications yet to be made, but we assure you that each future printing will turn out an updated manual.

### NOTE:

This manual is a revised edition of SR-7820-EN issued in Jan., 1980. It contains, from Group 22 (P.22-1) on, details of modifications and additions, which have been carried out since the above date of the first issue up to July, 1982. Be sure to read it thoroughly before your inspection and maintenance work and make effective use of it.

TRANSMISSION AND DIFFERENTIAL

DRIVE SHAFTS

SUSPENSION

STEERING SYSTEM

BRAKES

BODY

BODY ELECTRICAL EQUIPMENT

PERIODICAL INSPECTION SCHEDULE

**SUZUKI MOTOR CORPORATION**

TECHNICAL DEPARTMENT  
AUTOMOBILE SERVICE DIVISION

Copying, quoting or reproducing any part of this MANUAL is not permitted without explicit approval by SUZUKI MOTOR CORPORATION



### 1-3. Locations of Engine Number and Body Number

The engine number is punched on the skirt part of the cylinder block under the carburetor.

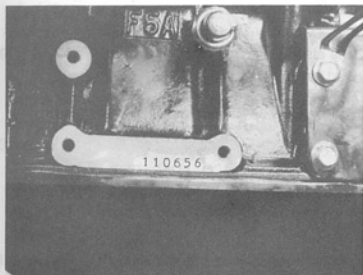
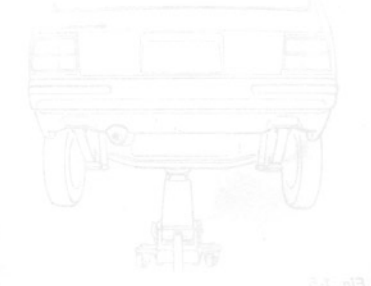
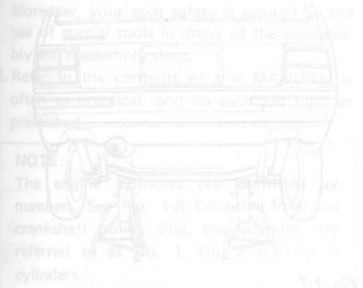


Fig. 1-2 Location of Engine No.

The body number is punched on the body in the engine room as shown below.



Fig. 1-3 Location of Body No.



#### 1-4. Standard Shop Practices

1. Protect the painted surfaces of the body, and avoid staining or tearing the seats. When working on the fenders and seats, be sure to cover them up with sheets.
2. Disconnect the negative terminal connection of the battery when working on any electrical part or component. This is necessary for avoiding electrical shocks and short-circuiting, and is very simple to accomplish: merely loosen the wing nut on the negative terminal and separate the cable from the terminal post.
3. In raising the front or rear end off the floor by jacking, be sure to put the jack up against the center portion of the rear axle housing or front suspension frame.



Fig. 1-4

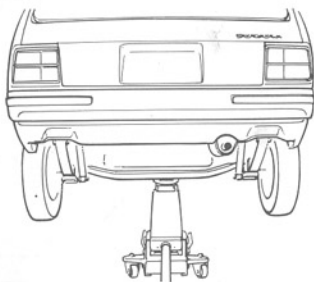


Fig. 1-5

4. To work on the front or rear end raised by jacking, be sure to place the safety stand under the front suspension frame or rear axle to support it in stable condition.



Fig. 1-6

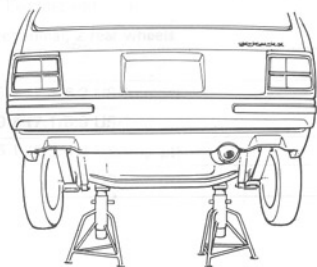


Fig. 1-7

5. Have wheel chocks for ready use in the shop. Chock the wheels securely when raising one end of the machine.
6. Orderliness is a key to successful overhauling. Trays, pans and shelves are needed to set aside the disassembled parts in groups or sets in order to avoid confusion and misplacement. This is particularly important for engine overhauling.
7. Have on hand the liquid packing - SUZUKI BOND No. 4 (99000-31030) - for ready use. This packing dope is an essential item assures leak-free (water and oil) workmanship.

8. Each bolt must be put back to where it was taken from or for which it is intended. Do not depend on your hunch in tightening the bolts for which tightening torque values are specified: be sure to use torque wrenches on those bolts.
9. It is advisable to discard and scrap gaskets and "O" rings removed in disassembly. Use new ones in reassembly, and try not to economize gaskets and "O" rings.
10. Use of Genuine SUZUKI parts is imperative. Use of imitation parts is a big gamble on safety and performance. Use Genuine SUZUKI parts and live up to the trust your customer places on you.
11. Special tools save time and ensure good workmanship: They are available from SUZUKI. Use them where their use is specified. Moreover, your own safety is assured by the use of special tools in many of the disassembly and reassembly steps.
12. Refer to the contents of this MANUAL as often as practical, and do each job right as prescribed.

**NOTE:**

The engine cylinders are identified by numbers. See Fig. 1-8. Counting from the crankshaft pulley side, the cylinders are referred to as No. 1, No. 2 and No. 3 cylinders.

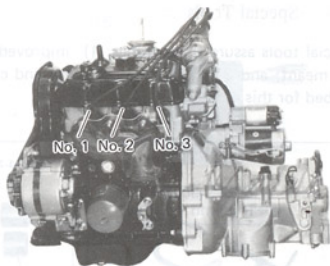


Fig. 1-8 Engine cylinder numbers

## 2-1. Tightening Torque Schedule

In threaded fastening parts holding down a component in place, the holding force is preserved primarily in the male and female threads in contact. Screw threads are capable of withstanding this force up to a certain limit. Here occurs the need to tighten them without exceeding the limit, and this need can be met by using torque wrenches.

Fastening parts, for which the limit is specified because their fastening or holding function is critical, is listed below. Use torque wrenches and adhere to the torque specifications when tightening them at the time of periodical inspection or overhauling or servicing.

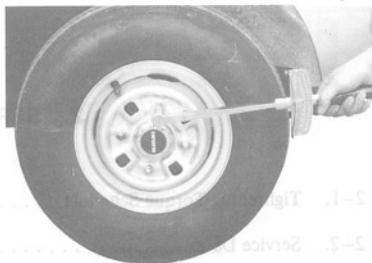


Fig. 2-1

System	Fastening parts	Tightening torque		
		N.m	kg-m	lb-ft
Engine	Cylinder head bolt	55 - 60	5.5 - 6.0	40.0 - 43.0
	Spark plug	20 - 30	2.0 - 3.0	14.5 - 21.5
	Inlet & exhaust manifold nut	18 - 23	1.8 - 2.3	13.0 - 16.5
	Camshaft timing pulley bolt	50 - 60	5.0 - 6.0	36.5 - 43.0
	Valve adjusting nut	15 - 20	1.5 - 2.0	11.0 - 14.0
	Timing belt cover bolt	3 - 4	0.3 - 0.4	2.5
	Crankshaft pulley bolt	50 - 60	5.0 - 6.0	36.5 - 43.0
	Connecting rod bearing cap nut	28 - 32	2.8 - 3.2	20.5 - 23.0
	Crankshaft bearing cap bolt	55 - 60	5.5 - 6.0	40.0 - 43.0
	Flywheel bolt	40 - 45	4.0 - 4.5	29.0 - 32.5
	Oil pressure unit	12 - 15	1.2 - 1.5	9.0 - 10.5
	Oil filter Ass'y	10 - 15	1.0 - 1.5	7.5 - 10.5
	Oil filter stand	20 - 25	2.0 - 2.5	14.5 - 18.0
	Oil pan bolt	4 - 5	0.4 - 0.5	3.0 - 3.5
	Oil drain plug	20 - 25	2.0 - 2.5	14.5 - 18.0
	Engine mounting nut	23 - 28	2.3 - 2.8	16.5 - 20.0
	Cylinder head cover bolt	4 - 5	0.4 - 0.5	3.0 - 3.5
	Engine suspension frame bolt	40 - 60	4.0 - 6.0	29.0 - 43.0
Engine suspension frame support bolt	50 - 70	5.0 - 7.0	36.5 - 51.0	

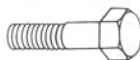
System	Fastening parts	Tightening torque		
		N.m	kg-m	lb-ft
Engine	Rocker arm shaft screw	9 - 12	0.9 - 1.2	7.0 - 8.5
	Camshaft thrust plate screw	9 - 12	0.9 - 1.2	7.0 - 8.5
	Oil pump gear plate screw	9 - 12	0.9 - 1.2	7.0 - 8.5
Gearshifting control	Gearshift control rod rear nut	8 - 10	0.8 - 1.0	5.5 - 7.5
	Gearshift control rod front nut	8 - 10	0.8 - 1.0	5.5 - 7.5
	Control lever guide plate bolt	8 - 10	0.8 - 1.0	5.5 - 7.5
	Control lever housing bolt	25 - 40	2.5 - 4.0	18.0 - 29.0
	Control lever housing nut	15 - 20	1.5 - 2.0	10.5 - 14.5
	Extension rod nut	25 - 40	2.5 - 4.0	18.0 - 29.0
Transmission and Differential	Oil drain plug and level plug	30 - 50	3.0 - 5.0	22.0 - 36.0
	Rear mounting nut	23 - 28	2.3 - 2.8	16.5 - 20.0
	Differential case bolt	80 - 100	8.0 - 10.0	58.0 - 72.0
Suspension	Leaf spring U bolt nut	30 - 45	3.0 - 4.5	21.5 - 33.0
	Leaf spring front nut	45 - 70	4.5 - 7.0	32.5 - 51.0
	Leaf spring shackle pin nut	30 - 55	3.0 - 5.5	21.5 - 40.0
	Front strut support nut	18 - 28	1.8 - 2.8	13.0 - 20.0
	Front strut lock nut	40 - 60	4.0 - 6.0	28.5 - 43.5
	Front strut bracket lock nut	70 - 90	7.0 - 9.0	50.5 - 65.5
	Stabilizer bar castle nut	40 - 90	4.0 - 9.0	28.5 - 65.5
	Stabilizer bar mount bolt	30 - 55	3.0 - 5.5	21.5 - 40.0
	Wheel nut	50 - 70	5.0 - 7.0	36.0 - 51.0
	Drive shaft castle nut	150 - 270	15.0 - 27.0	108.0 - 195.5
	Lower arm bolt	50 - 70	5.0 - 7.0	36.0 - 51.0
	Lower ball joint bolt	50 - 65	5.0 - 6.5	36.0 - 47.0
	Rear axle castle nut	80 - 120	8.0 - 12.0	57.5 - 87.0

System	Fastening parts	Tightening torque		
		N.m	kg-m	lb-ft
Steering	Steering shaft nut	25 - 40	2.5 - 4.0	18.0 - 28.5
	Steering shaft joint bolt	20 - 30	2.0 - 3.0	14.0 - 22.0
	Steering column bolt	11 - 17	1.1 - 1.7	7.5 - 12.5
	Steering gear case bolt	20 - 30	2.0 - 3.0	14.0 - 22.0
	Steering pinion securing nut	55 - 80	5.5 - 8.0	40.0 - 57.5
	Tie rod end lock nut	35 - 55	3.5 - 5.5	25.5 - 39.5
	Tie rod end castle nut	40 - 55	4.0 - 5.5	28.5 - 39.5
Brake	Brake backing plate bolt	18 - 28	1.8 - 2.8	13.0 - 20.0
	Brake master cylinder nut	25 - 40	2.5 - 4.0	18.0 - 28.5
	Brake tube union nut	15 - 18	1.5 - 1.8	11.0 - 13.0
	Brake flexible hose nut	20 - 40	2.0 - 4.0	14.5 - 28.5
	Brake shoe adjuster mounting nut	13 - 23	1.3 - 2.3	9.0 - 17.0
	Brake pipe 3-way joint bolt	8 - 10	0.8 - 1.0	5.5 - 7.0
	Brake pedal bolt nut	18 - 28	1.8 - 2.8	13.0 - 20.0
	Proportioning valve bolt	8 - 10	0.8 - 1.0	5.5 - 7.0
	Brake bleeder plug	9 - 13	0.9 - 1.3	6.5 - 9.5
	Wheel cylinder mounting nut	7 - 11	0.7 - 1.1	5.0 - 8.0

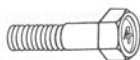
For other bolts and nuts not listed above, refer to this chart:

#### Tightening Torque

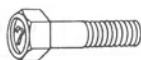
Bolt Diameter (mm)	Conventional or "4" Marked Bolt			"7" Marked Bolt		
	N.m	kg-m	lb-ft	N.m	kg-m	lb-ft
5	2 - 4	0.2 - 0.4	1.5 - 3.0	3 - 6	0.3 - 0.6	2.0 - 4.5
6	4 - 7	0.4 - 0.7	3.0 - 5.0	8 - 12	0.8 - 1.2	6.0 - 8.5
8	10 - 16	1.0 - 1.6	7.0 - 11.5	18 - 28	1.8 - 2.8	13.0 - 20.0
10	22 - 35	2.2 - 3.5	16.0 - 25.0	40 - 60	4.0 - 6.0	29.0 - 43.5



Conventional Bolt



"4" Marked Bolt



"7" Marked Bolt



## 2-2. Service Data

## ENGINE

Item		Standard		Service Limit			
Compression pressure		13.5 kg/cm <sup>2</sup> (192.0 psi) 400 r/min		10.0 kg/cm <sup>2</sup> (142.2 psi) 400 r/min			
	Difference between cylinders	_____		1.0 kg/cm <sup>2</sup> (14.2 psi) 400 r/min			
Valve clearance (Inlet, Exhaust)	Cold	0.13 ~ 0.18 mm (0.005 ~ 0.007 in.)		_____			
	Hot	0.23 ~ 0.28 mm (0.009 ~ 0.011 in.)		_____			
Ignition Timing		10° B.T.D.C. below 950 r/min		_____			
Cylinder head	Flatness of gasketed surface		_____		0.05 mm (0.002 in.)		
	Flatness of manifold seat	Inlet	_____		0.1 mm (0.004 in.)		
		Outlet	_____		0.1 mm (0.004 in.)		
	Valve seat	Seating width	Inlet	1.3 ~ 1.5 mm (0.0512 ~ 0.0590 in.)		_____	
		Exhaust	1.3 ~ 1.5 mm (0.0512 ~ 0.0590 in.)		_____		
Seating angle		45°		_____			
Camshaft/Journal clearance		0.050 ~ 0.091 mm (0.0020 ~ 0.0036 in.)		0.15 mm (0.0059 in.)			
Camshaft thrust clearance		0.050 ~ 0.150 mm (0.0020 ~ 0.0059 in.)		0.30 mm (0.0118 in.)			
Cam height (Base circle + lift)	Inlet	36.152 mm (1.4233 in.)		36.100 mm (1.4212 in.)			
		36.152 mm (1.4233 in.)		36.100 mm (1.4212 in.)			
	Fuel pump cam	33.300 mm (1.3110 in.)		33.000 mm (1.2992 in.)			
Camshaft deflection		_____		0.10 mm (0.0039 in.)			
Valve, Valve spring & Cam shaft	Valve stem diameter	Inlet	6.965 ~ 6.980 mm (0.2742 ~ 0.2748 in.)		_____		
		Exhaust	6.955 ~ 6.970 mm (0.2738 ~ 0.2744 in.)		_____		
	Valve guide I.D.	Inlet	7.000 ~ 7.015 mm (0.2755 ~ 0.2761 in.)		_____		
		Exhaust	7.000 ~ 7.015 mm (0.2755 ~ 0.2761 in.)		_____		
	Valve guide-to-valve stem clearance	Inlet	0.020 ~ 0.050 mm (0.0008 ~ 0.0019 in.)		0.07 mm (0.0027 in.)		
		Exhaust	0.030 ~ 0.060 mm (0.0012 ~ 0.0023 in.)		0.09 mm (0.0035 in.)		
	Thickness of valve head periphery	Inlet	0.80 ~ 1.20 mm (0.0315 ~ 0.0472 in.)		0.6 mm (0.0236 in.)		
		Exhaust	0.80 ~ 1.20 mm (0.0315 ~ 0.0472 in.)		0.7 mm (0.0275 in.)		
	Contact width of valve and valve seat	Inlet	1.3 ~ 1.5 mm (0.0512 ~ 0.0590 in.)		_____		
		Exhaust	1.3 ~ 1.5 mm (0.0512 ~ 0.0590 in.)		_____		
	Valve spring free length	Inlet	47.7 mm (1.8779 in.)		46.5 mm (1.8307 in.)		
		Exhaust	47.7 mm (1.8779 in.)		46.5 mm (1.8307 in.)		
	Valve spring preload	Inlet	26 ~ 30 kg (57.3 ~ 66.1 lb) for fitting length 40 mm (1.57 in.)		24 kg (52.9 lb) for fitting length 40 mm (1.57 in.)		
		Exhaust	26 ~ 30 kg (57.3 ~ 66.1 lb) for fitting length 40 mm (1.57 in.)		24 kg (52.9 lb) for fitting length 40 mm (1.57 in.)		

Item		Standard	Service Limit	
Rocker arm shaft and rocker arm	Rocker shaft O.D.	14.965 ~ 14.980 mm (0.589 ~ 0.590 in.)	_____	
	Rocker arm I.D.	14.985 ~ 15.005 mm (0.590 ~ 0.591 in.)	_____	
	Shaft-to-arm clearance	Inlet	0.005 ~ 0.040 mm (0.0002 ~ 0.0016 in.)	0.07 mm (0.0027 in.)
		Exhaust	0.005 ~ 0.040 mm (0.0002 ~ 0.0016 in.)	0.07 mm (0.0027 in.)
Rocker shaft deflection		_____	0.06 mm (0.0023 in.)	
Cylinder	Flatness of gasketed surface		0.05 mm (0.0020 in.)	
	Cylinder bore (S.T.D.)		62.005 ~ 62.020 mm (2.4411 ~ 2.4417 in.)	
	Difference in bore between cylinders		_____	0.05 mm (0.0020 in.)
	Wear limit on bore		_____	0.05 mm (0.0020 in.)
	Cylinder-to-piston clearance		0.040 ~ 0.050 mm (0.0016 ~ 0.0020 in.)	_____
Piston	Piston diameter	Standard	61.960 ~ 61.975 mm (2.4393 ~ 2.4399 in.)	
		Oversize: 0.25 mm (0.0098 in.)	62.210 ~ 62.225 mm (2.4492 ~ 2.4498 in.)	
		Oversize: 0.50 mm (0.0196 in.)	62.460 ~ 62.475 mm (2.4590 ~ 2.4596 in.)	
	Piston ring groove width	Top ring	1.52 ~ 1.54 mm (0.0598 ~ 0.0606 in.)	_____
		2nd ring	1.51 ~ 1.53 mm (0.0594 ~ 0.0602 in.)	_____
		Oil ring	2.81 ~ 2.83 mm (0.1106 ~ 0.1114 in.)	_____
	Piston pin diameter		15.995 ~ 16.000 mm (0.6297 ~ 0.6299 in.)	_____
	Piston pin clearance in con. rod		0.003 ~ 0.016 mm (0.0001 ~ 0.0006 in.)	0.05 mm (0.0020 in.)
Piston ring	Piston ring thickness	Top ring	1.47 ~ 1.49 mm (0.0578 ~ 0.0586 in.)	
		2nd ring	1.47 ~ 1.49 mm (0.0578 ~ 0.0586 in.)	
		Oil ring	0.45 mm (0.0177 in.)	
	Ring clearance in groove	Top ring	0.03 ~ 0.07 mm (0.0012 ~ 0.0027 in.)	0.12 mm (0.0047 in.)
		2nd ring	0.02 ~ 0.06 mm (0.0008 ~ 0.0023 in.)	0.10 mm (0.0039 in.)
	Piston ring end gap	Top ring	0.15 ~ 0.35 mm (0.0059 ~ 0.0137 in.)	0.7 mm (0.0275 in.)
		2nd ring	0.15 ~ 0.35 mm (0.0059 ~ 0.0137 in.)	0.7 mm (0.0275 in.)
		Oil ring	0.30 ~ 0.90 mm (0.0118 ~ 0.0354 in.)	1.8 mm (0.0708 in.)
	Crankshaft	Crankshaft deflection (middle)		_____
Crank pin diameter		37.985 ~ 38.000 mm (1.4954 ~ 1.4960 in.)		
Crank pin clearance in con. rod		0.020 ~ 0.040 mm (0.0008 ~ 0.0016 in.)	0.08 mm (0.0031 in.)	
Connecting rod small end bore		16.003 ~ 16.011 mm (0.6300 ~ 0.6303 in.)	_____	
Crank journal diameter		39.982 ~ 40.000 mm (1.5741 ~ 1.5748 in.)	_____	
Bearing-to-journal clearance		0.020 ~ 0.040 mm (0.0008 ~ 0.0016 in.)	0.08 mm (0.0032 in.)	

Item		Standard		Service Limit
Crankshaft	Crankshaft thrust play	0.13 ~ 0.28 mm	(0.0051 ~ 0.0110 in.)	0.35 mm (0.0138 in.)
	Connecting rod big end thrust clearance	0.10 ~ 0.20 mm	(0.0039 ~ 0.0078 in.)	0.30 mm (0.0118 in.)
	Connecting rod	Twist	—————	0.10 mm (0.0039 in.)
Straightness		—————	0.05 mm (0.0020 in.)	

## CLUTCH & TRANSMISSION

Item		Standard		Service Limit	
Clutch	Pedal play	15 - 25 mm	(0.6 - 1.0 in.)	—————	
	Facing wear (Rived head depression)	1.2 mm	(0.05 in.)	0.5 mm (0.02 in.)	
	Facing-input shaft serration backlash	~	—————	0.5 mm (0.02 in.)	
	Clutch release arm play	2 ~ 4 mm	(0.08 ~ 0.16 in.)	—————	
Transmission	Clearance between gears and rings	0.8 ~ 1.2 mm	(0.03 ~ 0.05 in.)	0.5 mm (0.02 in.)	
	Key slot width of synchronizer ring	Low gear	7.8 mm (0.31 in.)	8.1 mm (0.32 in.)	
		Second, third and top gear	9.6 mm (0.38 in.)	9.9 mm (0.39 in.)	
	Fork shaft locating spring	Free length	19.5 mm	(0.767 in.)	17.0 mm (0.669 in.)
	Low & second gear backlash	0.10 ~ 0.15 mm	(0.0039 ~ 0.0059 in.)	0.3 mm (0.0118 in.)	
	Third & top gear backlash	0.15 ~ 0.20 mm	(0.0059 ~ 0.0078 in.)	0.3 mm (0.0118 in.)	
Reverse gear-reverse idle gear backlash	0.15 ~ 0.30 mm	(0.0059 ~ 0.0118 in.)	0.4 mm (0.0157 in.)		

## LUBRICATION

Item		Standard		Service Limit	
Lubrication	Outer gear periphery clearance in pump case	0.05 ~ 0.10 mm	(0.0020 ~ 0.0039 in.)	0.15 mm (0.0059 in.)	
	Outer gear tooth clearance in pump case	0.058 ~ 0.31 mm	(0.0023 ~ 0.0122 in.)	—————	
	Inner gear tooth clearance in pump case	0.177 ~ 0.328 mm	(0.0070 ~ 0.0129 in.)	—————	
	Oil pump side clearance (flatness)	0.035 ~ 0.085 mm	(0.0014 ~ 0.0033 in.)	0.15 mm (0.0059 in.)	
	Oil relief valve spring	Free length	45 mm	(1.77 in.)	—————
		10.7 mm (0.42 in) Compressive force	6.206 kg	(13.681 lb)	5.300 kg (11.684 lb)
Set pressure of oil pressure switch	0.2 ~ 0.4 kg/cm <sup>2</sup>	(2.84 ~ 5.68 psi)	—————		

## COOLING SYSTEM

Item	Standard	Service Limit
Fan belt tension as deflection under 10 kg (22 lb) push applied to middle point between pulleys	10 ~ 15 mm (0.4 ~ 0.6 in.)	_____
Thermostat start-to-open temperature	82°C (179°F)	_____
Thermostat full-open temperature	95°C (203°F)	_____
Valve lift	8 mm (0.31 in.)	_____

## DIFFERENTIAL

Item	Standard	Service Limit
Side gear backlash	0.05 ~ 0.10 mm (0.002 ~ 0.004 in.)	_____
Final gear backlash	0.08 ~ 0.12 mm (0.003 ~ 0.005 in.)	_____

## SUSPENSION

Item	Standard	Service Limit
Front coil spring rate	1.48 kg/mm (83 lb/in.)	_____
Rear leaf spring rate	2.6 kg/mm (145.6 lb/in.)	_____
Front coil spring free length	342 mm (13.5 in.)	_____
Rear leaf spring free height	156 mm (6.1 in.)	_____
Front strut stroke	135 mm (5.3 in.)	_____
Rear shock absorber stroke	175 mm (6.9 in.)	_____

## STEERING SYSTEM

Item	Standard		Service Limit
Gear ratio (gear case)	17.5 : 1		_____
Steering angle, inside	38°		_____
Steering angle, outside	32°		_____
Steering wheel diameter	384 mm	(15.1 in.)	_____
Minimum turning radius	4.4 m	(14.4 ft.)	_____
Tire inflating pressure	Front	167 kPa (1.7 kg/cm <sup>2</sup> , 24 psi)	_____
	Rear	235 kPa (2.4 kg/cm <sup>2</sup> , 34 psi)	_____
Toe-in	2 ~ 4 mm (0.079 ~ 0.157 in.)		_____
Camber angle	1° 20'		_____
Trail	13 mm	(0.51 in.)	_____
King pin inclination	12° 50'		_____
Caster angle	3° 15'		_____

## BRAKE

Item	Standard		Service Limit
Brake drum inside diameter	180 mm	(7.087 in.)	182 mm (7.165 in.)
Brake drum "out-of-round"	0 mm	(0 in.)	0.5 mm (0.02 in.)
Brake lining thickness (lining + shoe rim)	7.0 mm	(0.27 in.)	3.0 mm (0.12 in.)
Pedal-to-wall clearance When pedal is depressed at 30 kg (66 lb)	50 mm (1.97 in.) minimum		

## ELECTRICAL

Item		Standard	Service Limit
Ignition system	Ignition timing	10° B.T.D.C. below 950 r/min (rpm)	_____
	Ignition order	1 - 3 - 2	_____
	Breaker point gap	0.4 - 0.5 mm (0.016 - 0.019 in.)	_____
	Cam dwell angle	62°	_____
	Condenser capacitance	0.25 microfarad	_____
	Ignition coil, Primary winding resistance	About 3 ohm (inclusive of the 1.5-ohm resistor)	_____
	Ignition coil; Secondary winding resistance	About 8 kilohms	_____
Starter motor	Voltage	12 Volts	_____
	Output	0.6 kw	_____
	Rating	30 seconds	_____
	Brush length	19 mm (0.75 in.)	12 mm (0.47 in.)
	Number of pinion teeth	9	_____
	Commutator diameter	32.5 mm (1.28 in.)	_____
	Mica undercut	0.5 - 0.8 mm (0.02 - 0.03 in.)	0.2 mm (0.007 in.)
Charging system	Nominal operating voltage	12 Volts	_____
	Maximum alternator output	35A	_____
	Effective pulley diameter	65 mm (2.56 in.)	_____
	Maximum permissible alternator speed	13,000 r/min (rpm)	_____
	Working temperature range	-40 - 80°C (-104 - 176°F)	_____
	Rotor; Ring-to-ring circuit resistance	4 - 5 ohms	_____
	Brush length	16.5 mm (0.65 in.)	11.0 mm (0.45 in.)
	Standard output voltage and current	13.8 - 14.8 Volts, 20 A minimum	_____
	Regulated Voltage	13.8 - 14.8 Volts	_____
	Voltage-relay cut in Voltage	4 - 5.8 Volts	_____
	Prescribed cut in Voltage	4 - 4.5 Volts	_____
Field circuit resistance	Several ohms	_____	



#### 4-1. Description

- 1) The engine is a water-cooled, in-line 3 cylinders, 4-stroke cycle gasoline unit with its S.O.H.C. (single overhead camshaft) valve mechanism arranged for "V"-type valve configuration.

The single overhead camshaft (S.O.H.C.) is mounted over the cylinder head; it is driven from crankshaft through timing belt. Unlike conventional overhead valve (O.H.V.) engines, this engine has no pushrods. Thus, drive for valves is more direct and enables the valves to follow the crankshaft without any delay.

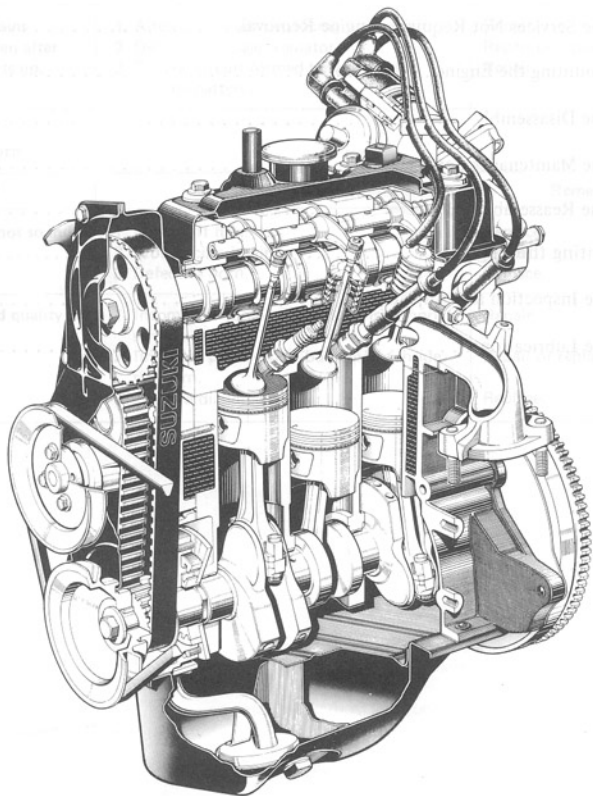


Fig. 4-1

2) The distinctive features of this engine may be summarized as follows:

1. Because of inlet and exhaust ports arranged for cross-flow pattern, with valves located in "V"-type configuration, both volumetric and scavenging efficiencies are very high.
2. The combustion chamber formed between piston crown and cylinder head is of a multi-spherical type shaped to provide squish. This feature is calculated to make available greater horsepower from a lesser amount of fuel.
3. The supports for camshaft and rocker shafts are integral with the cylinder head, so that the valve mechanism noise is markedly reduced by the structural rigidity and, moreover, that the number of valve mechanism parts is reduced, let alone a more compact size of the engine.
4. The timing belt for driving the camshaft runs quiet and is light in weight.
5. A high-grade cast iron is used for the material of the cylinder block. The block is shaped to present deep skirts and retain greater rigidity.
6. The crankshaft is a one-piece forging, and is supported by four bearings for vibration-free running.
7. Heating by hot water is employed for the inlet manifold in order to facilitate fuel carburetion and ensure the uniform distribution of the mixture. The higher combustion efficiency of this engine is largely explained by this inlet manifold feature.
8. Smooth engine running with minimized vibration and noise is assured in contrast to comparable two-cylinder engines of 4 cycle type, because the three crankpins are  $120^\circ$  apart to make for balanced running and minimized speed fluctuation.

13. Distributor gear noise

14. Camshaft timing belt pulley

15. Crankshaft timing belt pulley

16. Timing case

17. Fuel pump

18. Carburetor

19. Intake manifold

20. Alternator

21. Starter motor

22. Water pump belt

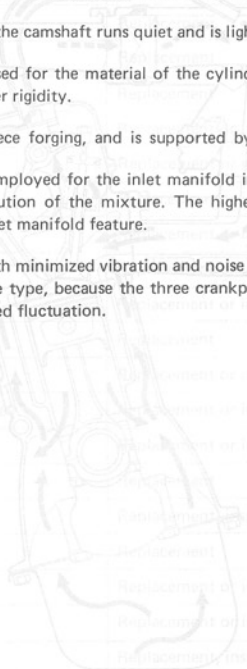
23. Water pump

24. Pulleys (crank, alternator, water pump)

25. Timing belt cover

26. Water hose

27. Oil pump



### 3) Blowby gas recycling system

Blowby gas passage is provided in the cylinder block to pass the blowby gases from crankcase to cylinder head. In the head cover, an oil separator removes oil particles from the gases before the gases are drawn into the air cleaner.

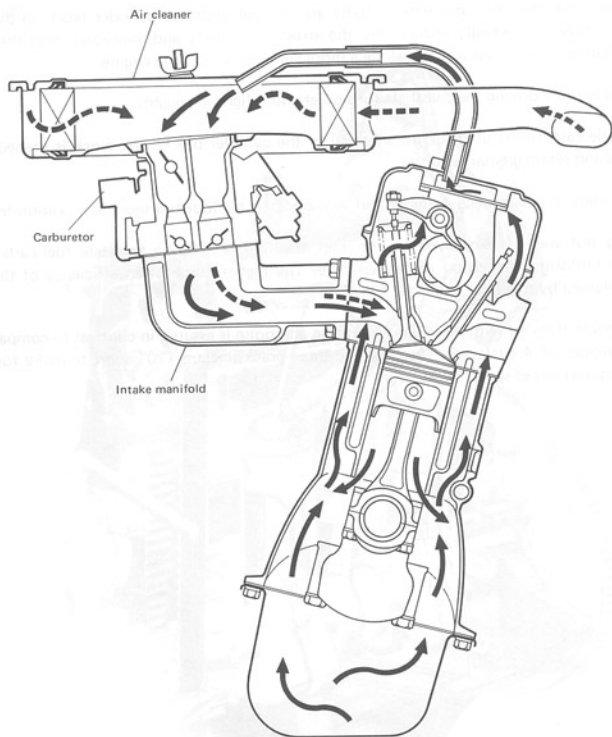


Fig. 4-2

#### 4-2. Engine Services Not Requiring Engine Removal

The following parts or components do not require engine removal to receive services (replacement, inspection or adjustment):

Part or Component	Nature of Service
1. Spark plug	Replacement or inspection
2. Distributor	Replacement, inspection or adjustment
3. Exhaust manifold	Replacement or inspection
4. Oil filter	Replacement
5. Oil pressure unit	Replacement
6. Cylinder head cover	Replacement
7. Rocker shaft	Replacement or inspection
8. Rocker-arm	Replacement or inspection
9. Rocker-arm spring	Replacement or inspection
10. Cam shaft	Replacement or inspection
11. Cylinder head	Replacement or inspection
12. Radiator	Replacement or inspection
13. Distributor gear case	Replacement
14. Camshaft timing belt pulley	Replacement or inspection
15. Crankshaft timing belt pulley	Replacement or inspection
16. Timing belt	Replacement or inspection
17. Fuel pump	Replacement
18. Carburetor	Replacement, inspection or adjustment
19. Intake manifold	Replacement
20. Alternator	Replacement or inspection
21. Starter motor	Replacement or inspection
22. Water pump belt	Replacement, inspection or tension adjustment
23. Water pump	Replacement
24. Pulleys (crank, alternator, water pump)	Replacement
25. Timing belt cover	Replacement
26. Water hose	Replacement or inspection
27. Oil pump	Replacement or inspection

### 4-3. Dismounting the Engine

1. Remove the front grille and upper member.
2. Disconnect negative (-) and positive (+) cords from the battery terminals, and remove the battery.
3. Remove the battery insulator from the battery tray.
4. Loosen the drain plug under the radiator and drain the cooling water.
5. Disconnect the radiator inlet hose from the thermostat cap.
6. Disconnect the radiator inlet and outlet hose from the radiator.
7. Disconnect the radiator fan lead wire at the coupler.
8. Disconnect the lead wire from the radiator fan thermo switch.
9. Pull off reserve tank hose from the reserve tank.
10. Remove the radiator from the body.
11. Pull off ignition coil high-tension cord from the distributor.
12. Disconnect the lead wire (brown) from distributor terminal.
13. Disconnect the lead wire (black/yellow) and positive (+) battery cord from the starter motor.
14. Disconnect the negative (-) battery cord from transmission case.
15. Disconnect the clutch cable from the clutch release lever and transmission case.
16. Disconnect the back light switch lead wire (red and yellow) at the coupler.
17. Release the transmission breather hose from its clamp.
18. Disconnect the speedometer cable from the transmission case.
19. Disconnect the coupler and lead wire (white) from the alternator terminals.
20. Remove the air cleaner case.
21. Disconnect the choke wire from the carburetor body.
22. Disconnect the accelerator wire from the carburetor body.
23. Disconnect the carburetor solenoid lead wire (black/white) at the joint part.
24. Disconnect the fuel return hose from the carburetor body.
25. Disconnect the lead wire (yellow) from the water TEMP. gauge.
26. Disconnect the lead wire (yellow/black) from the oil pressure gauge.
27. Disconnect the heater outlet hose from the water inlet pipe.
28. Disconnect the heater inlet hose from the heater control valve.
29. Remove the radiator outlet pipe and inlet hose.
30. Remove the torque rod from its brackets.
31. Lift the front end of the machine by jacking, and support it on safety stands.
32. Disconnect the exhaust center pipe from the exhaust manifold.
33. Remove the exhaust center pipe mounting bolt.
34. Disconnect the gear sift control shaft from transmission.
35. Disconnect the extension rod from the transmission.
36. Drain the transmission oil.

37. Disconnect the drive shafts (left & right) from differential side gear snap rings.

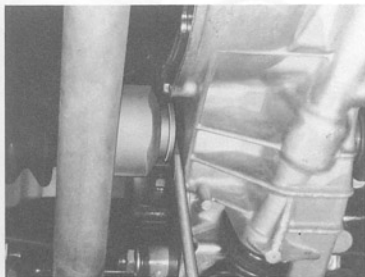


Fig. 4-3

38. Set a piece of wire across the hook on the inlet manifold and another safe place such as the exhaust manifold so that the engine can be lifted by using a chain block.

**CAUTION:**

Before finally lifting engine, recheck to ascertain all items are disconnected and free.

39. Remove the nuts securing the engine mountings to make the engine ready for removal.  
40. Lift the engine a little and pull the drive shafts (right & left) out of the spline of the differential side gear.  
41. Take down the engine.

**NOTE:**

Throughout this MANUAL, the three cylinders of the engine are identified by numbers: No. 1, No. 2 and No. 3 as counted from crankshaft pulley side.

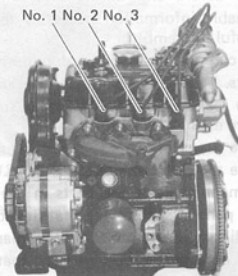


Fig. 4-4



#### 4-4. Engine Disassembly

##### NOTES:

- Observe critically before starting to remove a component or part by loosening bolts, nuts and the like. What you may find before and during disassembly is valuable information necessary for successful reassembly.
- Be careful in handling aluminum-alloy parts. They are softer than steel or cast-iron parts and their finished surfaces more easily take scratch marks.
- Have trays and pans ready for setting aside the disassembled parts in an orderly manner. Place the parts in the trays and pans in such a way that they can be readily identified. Put match marks or tags on them, as necessary, so that they will go back to where they came from.

Carry out engine disassembly in the following sequence:

Remove starter motor and loosen the transmission securing bolts.

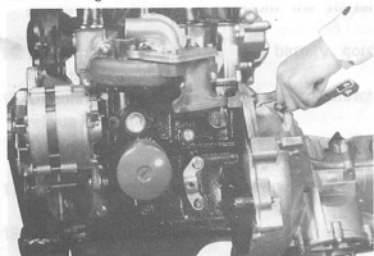


Fig. 4-5

Take off transmission case from cylinder block after removing clutch housing lower plate.

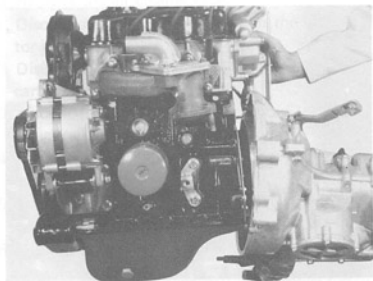


Fig. 4-6

Remove drain plug and drain out engine oil.

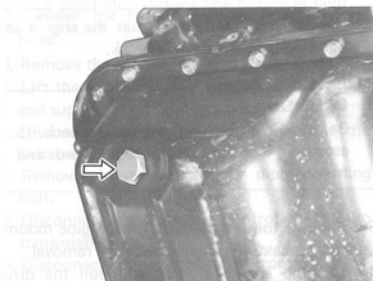


Fig. 4-7

Remove clutch cover.

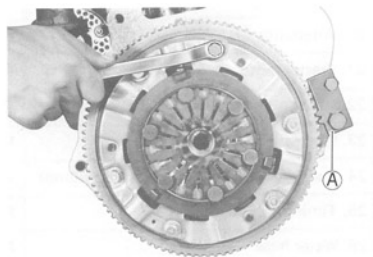


Fig. 4-8 A Flywheel stopper (09916-97820)

Remove distributor assembly.

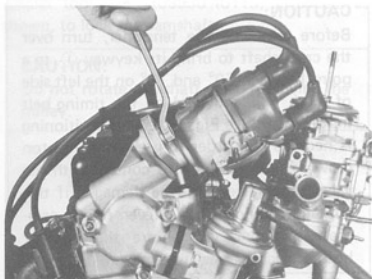


Fig. 4-9

Remove fuel pump.

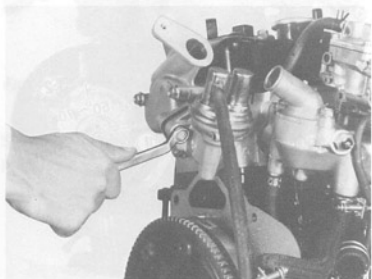


Fig. 4-10

Take down distributor case.

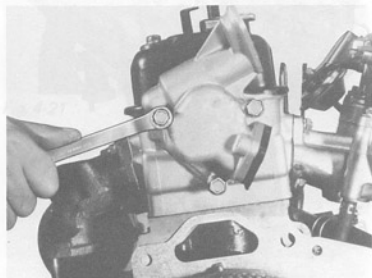


Fig. 4-11

Take down alternator.

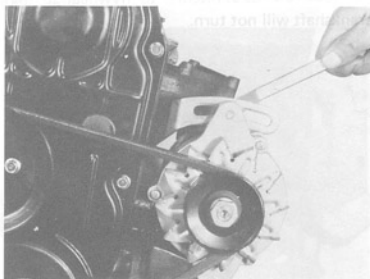


Fig. 4-12

Remove alternator mounting stay.

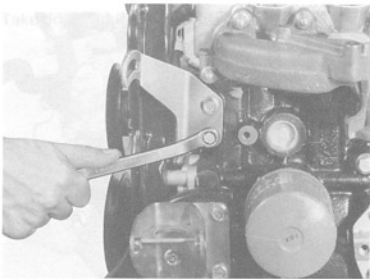


Fig. 4-13

Ease out water pump pulley.

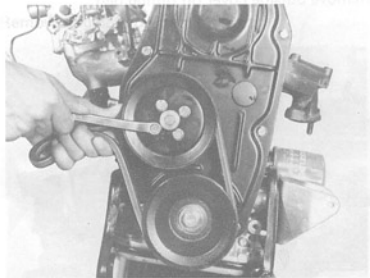


Fig. 4-14

Remove crank pulley similarly, with special tool **A** (09916-97820) hitched to flywheel so that crankshaft will not turn.



Fig. 4-15

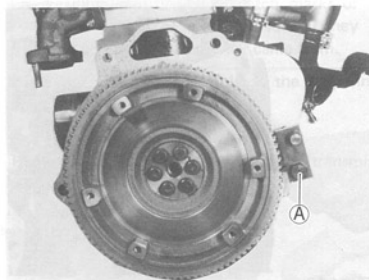


Fig. 4-16

Remove outside cover on timing belt.

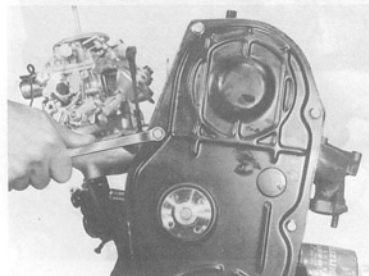


Fig. 4-17

Remove timing belt tensioner.

**CAUTION:**

Before removing the tensioner, turn over the crankshaft to bring its keyway **1** to a point between  $50^{\circ}$  and  $70^{\circ}$  on the left side of mark **2** provided on the timing belt inside cover. See Fig. 4-18. This positioning is necessary in order to prevent the piston crown from coming into contact with the valve. The valve could be damaged if this contact should occur. Never rotate crankshaft or crankshaft before the cylinder head or rocker arms are removed.

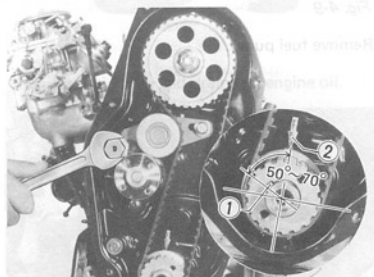


Fig. 4-18

Remove timing belt.

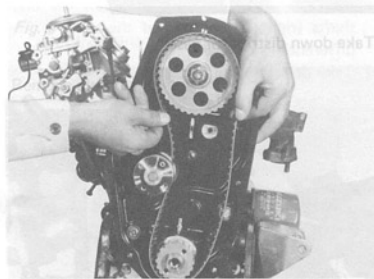


Fig. 4-19

Remove the camshaft timing belt pulley, with special tool **A** (09930-40113) attached, as shown, to lock the camshaft.

**CAUTION:**

Do not rotate camshaft when removing the pulley.

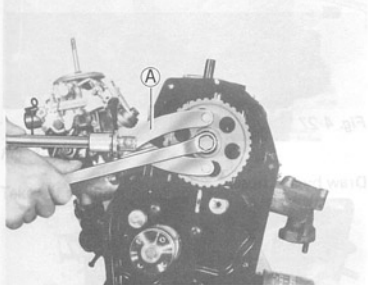


Fig. 4-20

Similarly remove the crankshaft timing belt pulley.

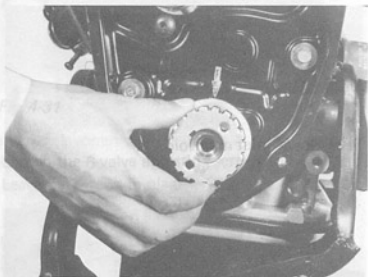


Fig. 4-21

After removing the pulley key, take out timing belt guide.

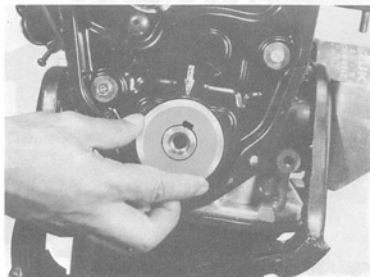


Fig. 4-22

Take down timing belt inside cover.

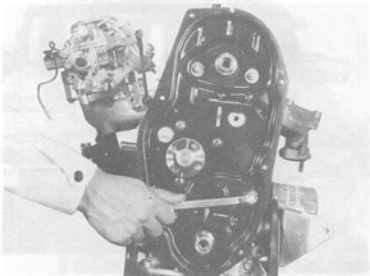


Fig. 4-23

Remove engine mounting bracket.

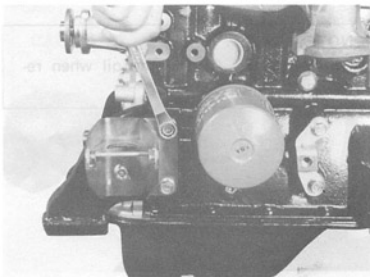


Fig. 4-24

Remove water pump case.

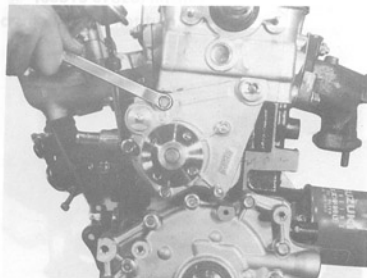


Fig. 4-25

Take off exhaust manifold and its gasket.

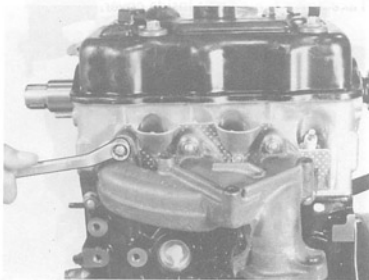


Fig. 4-26

Using special tool **A** (09915-47310), remove oil filter.

**NOTE:**

Be careful not to spill the oil when removing the filter.

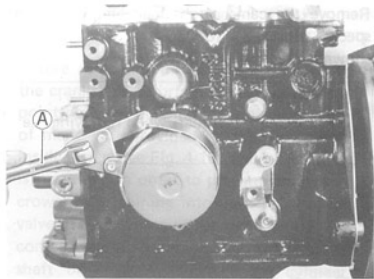


Fig. 4-27

Draw bypass hose.

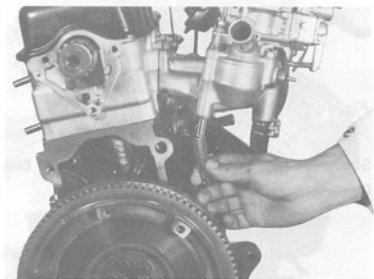


Fig. 4-28

Take down inlet manifold.

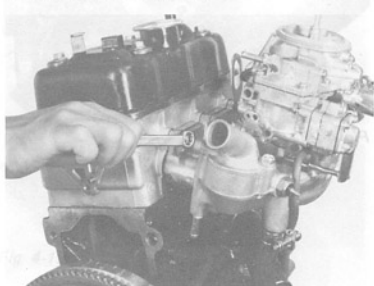


Fig. 4-29

Sever and remove water inlet pipe.

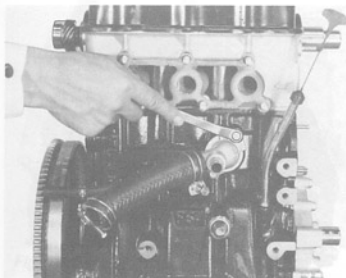


Fig. 4-30

Take off cylinder head cover.

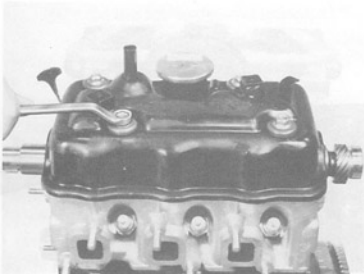


Fig. 4-31

Loosen the 6 valve adjusting screws fully. Leave the screws in place.

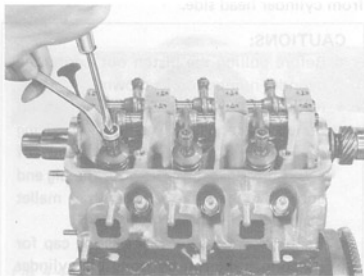


Fig. 4-32

Loosen rocker arm shaft securing screws: there are 8 screws.

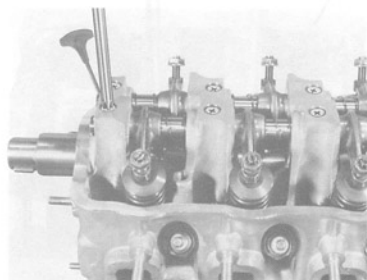


Fig. 4-33

While drawing out rocker arm shaft, separate valve rocker arms and rocker arm springs.

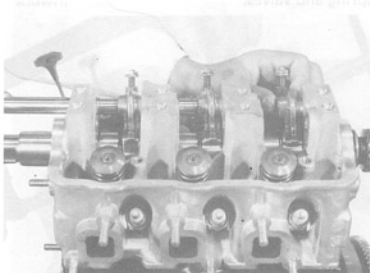


Fig. 4-34

Remove camshaft thrust plate, and draw camshaft out toward distributor gear case side.

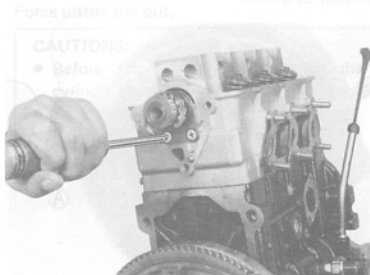


Fig. 4-35



Remove cylinder head.

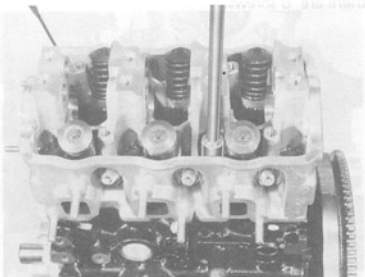


Fig. 4-36

Use valve lifter **A** (09916-14510) to compress the valve spring in order to free valve cotter pieces for removal. In this way, remove valve spring and valves.

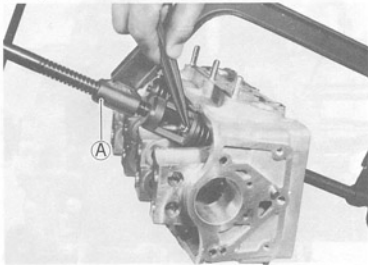


Fig. 4-37

Remove flywheel, using special tool **A** (09916-97820) as shown.

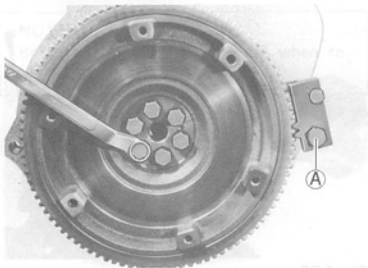


Fig. 4-38

Take down oil pan.

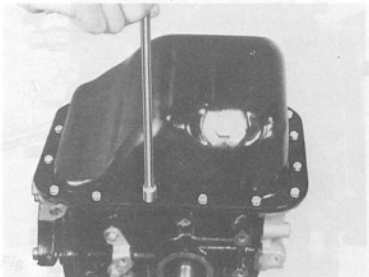


Fig. 4-39

Remove oil pump strainer.

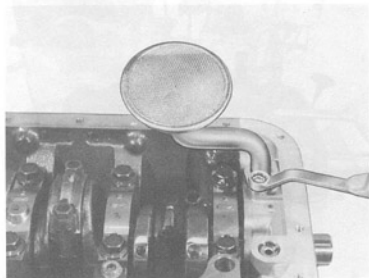


Fig. 4-40

As the first step of crankshaft removal, remove the three connecting rod caps and take out pistons, each complete with its connecting rod, from cylinder head side.

#### CAUTIONS:

- Before pulling the piston out, scribe the cylinder number on its crown.
- Never drive on the big end in an attempt to force the piston out. If driving is necessary to ease the big end off crankpin, run stud bolts into the big end and drive on the bolts with a mallet handle.
- Be sure to identify each bearing cap for its connecting rod by using the cylinder number. Set the cap and rod aside in combination.

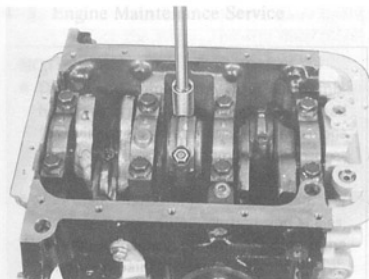


Fig. 4-41

Use compressed air to clear internal oil holes and passages.

Remove oil pump case.

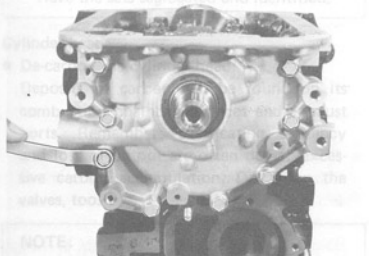


Fig. 4-42

NOTE: Do not use any sharp-edged tool to remove the oil pump case. Be careful not to scratch or nick the metal surfaces when disassembling.

Remove oil seal housing.

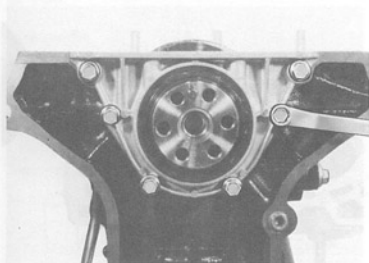


Fig. 4-43

Remove crankshaft bearing caps, and take out crankshaft.

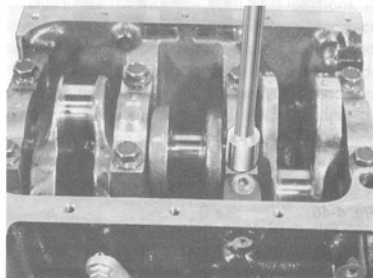


Fig. 4-44

From each piston, ease out piston pin circlips, as shown.



Fig. 4-45

Force piston pin out.

**CAUTIONS:**

- Before removing the pin, scribe the cylinder number on the connecting rod.
- Set the piston, piston pin and connecting rod, together with cap, in the tray or pan as a combination.

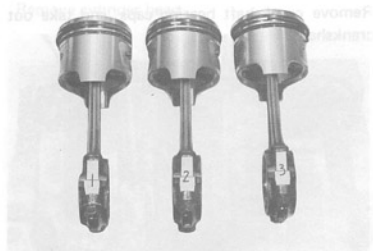


Fig. 4-46

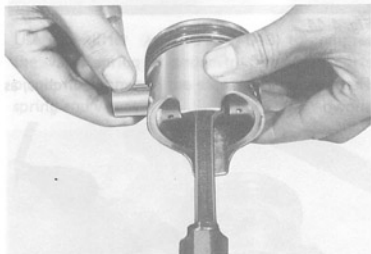


Fig. 4-47

## 4-5. Engine Maintenance Service

### NOTES:

- During and immediately after disassembly, inspect the cylinder block and head for evidence of water leakage or damage and, after washing them clean, inspect more closely.
- Wash all disassembled parts clean, removing grease, slime, carbon and scales, before inspecting them to determine whether repair is necessary or not. Be sure to de-scale the water jackets.
- Use compressed air to clear internal oil holes and passages.
- Do not disturb the set combinations of valves, bearings and bearing caps, etc. Have the sets segregated and identified.

### Cylinder head

#### • De-carbon the cylinder head:

Deposits of carbon will be found on its combustion chamber surfaces and exhaust ports. Remember, overheating tendency and loss of output are often due to excessive carbon accumulation. De-carbon the valves, too.

### NOTE:

Do not use any sharp-edged tool to scrape off the carbon. Be careful not to scuff or nick the metal surfaces when de-carboning. This applies to valves and valve seats, too.

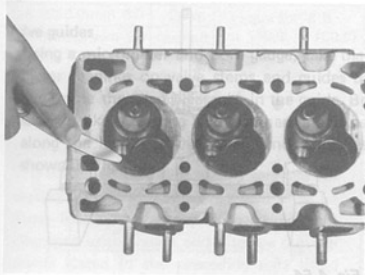


Fig. 4-48

#### • Flatness of gasketed surface:

Using a straightedge and thickness gauge, check the flatness at a total of 6 locations. If the limit, stated below, is exceeded, correct the gasketed surface with a surface plate and sandpaper of about #400: place the sandpaper on and over the surface plate, and rub the gasketed surface against the sandpaper to grind off high spots. Should this fail to reduce the thickness gauge readings to within the limit, replace the cylinder head.

Leakage of combustion gases from this gasketed joint is often due to a warped gasketed surface; such leakage results in reduced power output and hence a higher cost of fuel per kilometer.

Limit on flatness	0.05 mm (0.002 in.)
-------------------	---------------------

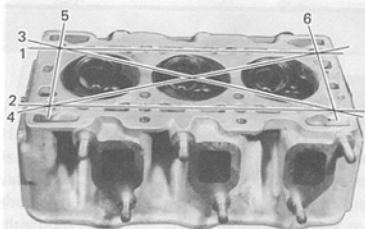


Fig. 4-49

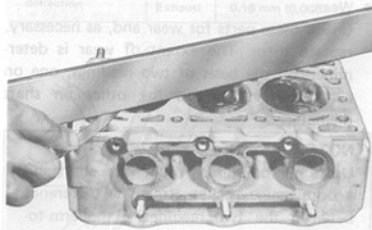


Fig. 4-50

● Flatness of manifold seating faces:

Check the seating faces of cylinder head for manifolds, using a straightedge and thickness gauge, in order to determine whether these faces should be corrected or the cylinder head replaced.

Limit on flatness	0.10 mm(0.004 in.)
-------------------	--------------------

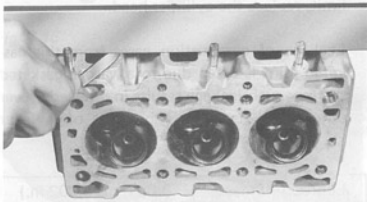


Fig. 4-51 Checking exhaust manifold seating face for flatness.

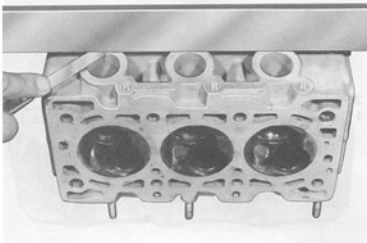


Fig. 4-52 Checking inlet manifold seating face for flatness.

**Rocker-arm shaft and rocker arms**

● Wear:

Check these parts for wear and, as necessary, replace them. The extent of wear is determined on the basis of two readings, one on rocker arm I.D. and the other on shaft diameter.

**NOTE:**

Use a micrometer on rocker-arm shaft and a bore gauge rocker arm. The difference between the two readings is the arm-to-shaft clearance on which a limit is specified. If the limit is exceeded, replace shaft or arm, or both.

Item	Standard	Limit
Rocker arm I.D.	14.985 - 15.005 mm (0.590 - 0.591 in.)	—
Rocker-arm shaft dia.	14.965 - 14.980 mm (0.589 - 0.590 in.)	—
Arm-to-shaft clearance	Inlet 0.005 - 0.040 mm (0.0002 - 0.0016 in.)	0.07 mm (0.0027 in.)
	Exhaust 0.005 - 0.040 mm (0.0002 - 0.0016 in.)	0.07 mm (0.0027 in.)

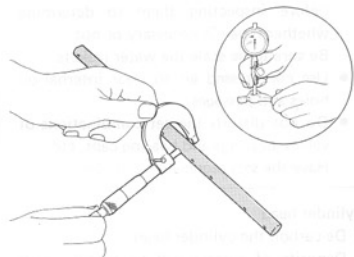


Fig. 4-53

● Rocker-arm shaft deflection:

Using "V" blocks and a dial gauge as shown in Fig. 4-54, check the shaft for straightness in terms of deflection. If the limit is exceeded, correct it by cold-working with a wooden mallet or replace it.

Deflection limit	0.06 mm (0.0023 in.)
------------------	----------------------

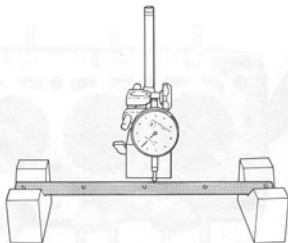


Fig. 4-54

- Flatness of manifold seating faces:

Check the seating faces of cylinder head for manifolds, using a straightedge and thickness gauge, in order to determine whether these faces should be corrected or the cylinder head replaced.

Limit on flatness	0.10 mm(0.004 in.)
-------------------	--------------------

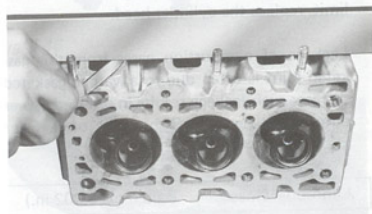


Fig. 4-51 Checking exhaust manifold seating face for flatness.

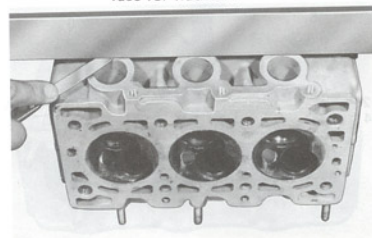


Fig. 4-52 Checking inlet manifold seating face for flatness.

#### Rocker-arm shaft and rocker arms

- Wear:

Check these parts for wear and, as necessary, replace them. The extent of wear is determined on the basis of two readings, one on rocker arm I.D. and the other on shaft diameter.

**NOTE:**

Use a micrometer on rocker-arm shaft and a bore gauge rocker arm. The difference between the two readings is the arm-to-shaft clearance on which a limit is specified. If the limit is exceeded, replace shaft or arm, or both.

Item	Standard	Limit
Rocker arm I.D.	14.985 - 15.005 mm (0.590 - 0.591 in.)	—
Rocker-arm shaft dia.	14.965 - 14.980 mm (0.589 - 0.590 in.)	—
Arm-to-shaft clearance	Inlet 0.005 - 0.040 mm (0.0002 - 0.0016 in.)	0.07 mm (0.0027 in.)
	Exhaust 0.005 - 0.040 mm (0.0002 - 0.0016 in.)	0.07 mm (0.0027 in.)

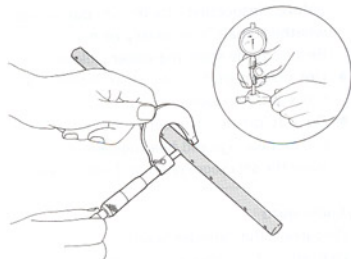


Fig. 4-53

- Rocker-arm shaft deflection:

Using "V" blocks and a dial gauge as shown in Fig. 4-54, check the shaft for straightness in terms of deflection. If the limit is exceeded, correct it by cold-working with a wooden mallet or replace it.

Deflection limit	0.06 mm (0.0023 in.)
------------------	----------------------

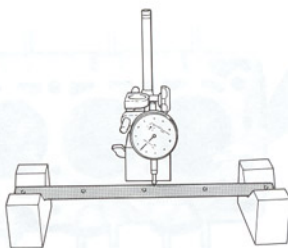


Fig. 4-54

- If the tip ① of adjusting screw ② is badly worn, replace the screw. The arm must be replaced if its cam-riding face ③ is badly worn.



Fig. 4-55

- Visually examine each rocker-arm spring for evidence of breakage or weakening. Be sure to replace springs found in bad condition.



Fig. 4-56

#### Valve guides

- Using a micrometer and bore gauge, take diameter readings on valve stems and guides to determine the stem clearance in the guide. Be sure to take a reading at more than one place along the length of each stem and guide, as shown in Fig. 4-57.

Item		Standard	Limit
Valve stem diameter	Inlet	6.965 - 6.980 mm (0.2742 - 0.2748 in.)	—
	Exhaust	6.965 - 6.970 mm (0.2738 - 0.2744 in.)	—
Valve guide I.D.	Inlet	7.000 - 7.015 mm (0.2755 - 0.2761 in.)	—
	Exhaust	7.000 - 7.015 mm (0.2755 - 0.2761 in.)	—
Stem-to-guide clearance	Inlet	0.020 - 0.050 mm (0.0008 - 0.0019 in.)	0.07mm (0.0027 in.)
	Exhaust	0.030 - 0.060 mm (0.0012 - 0.0023 in.)	0.09 mm (0.0035 in.)

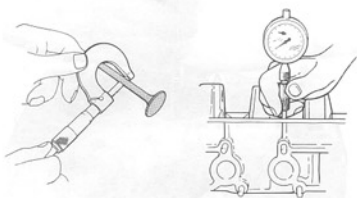


Fig. 4-57

If the bore gauge like the one shown in Fig. 4-57 is not available, check the end deflection of the valve stem in place with a dial gauge rigged as shown in Fig. 4-58. Move the stem end in the directions ④ ⑤ and determine whether replacement is necessary or not, by referring to these limiting values:

Valve stem end deflection	Inlet	0.12 mm (0.0047 in.)
	Exhaust	0.16 mm (0.0063 in.)

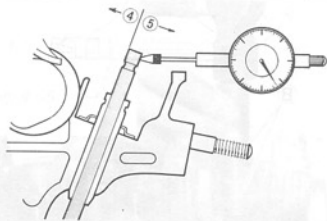


Fig. 4-58

● Valve guide replacement:

Valve guides are shrink-fitted. The method of removal and installation is as follows:

- Using the guide remover (A) (09916-44510), drive the valve guide out to remove it from the top side of cylinder head. After driving the guide out, ream the guide hole with a 12 mm (0.472 in.) reamer (Special tool 09916-37310) to remove burrs, making sure that the hole diameter after reaming comes within this range:

Valve guide hole diameter	Inlet	12.030 - 12.048 mm (0.4736 - 0.4743 in.)
	Exhaust	

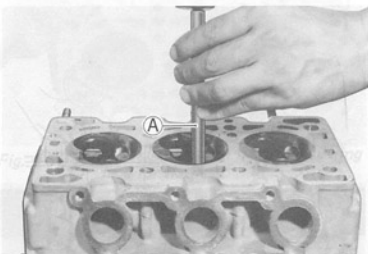


Fig. 4-59

- Heat the cylinder head uniformly at anywhere between 80° C and 100° C (176° F-212° F) so that the head will not distort, and drive the oversize guide into the hole with the valve guide installer set (B) (09916-57310 and 09916-57320). See Fig. 4-60. Be sure to carry out this step speedily so that all guides will go into the cylinder head in steady temperature state.

Valve guide oversize	0.03 mm (0.0012 in.)
Valve guide protrusion (1)	16.5 mm (0.649 in.)

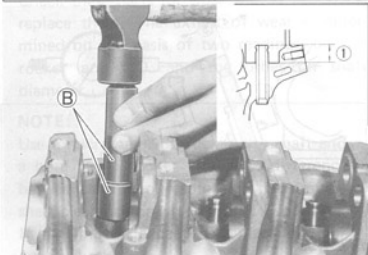


Fig. 4-60

**NOTE:**

Valve guide length differs between INLET and EXHAUST. It is 52.5 mm (2.067 in.) for INLET but 54.5 mm (2.145 in.) for EXHAUST.

- Check all valve guides in place for I.D. and, if the I.D. reading compared with the stem diameter reading indicates too small a radial clearance, ream the guide I.D. with the reamer (C) (09916-34520), as shown in Fig. 4-61.

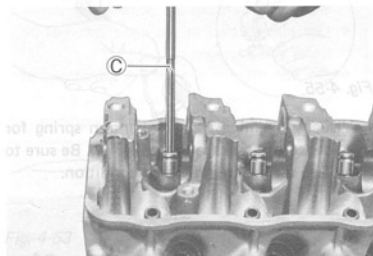


Fig. 4-61

**Valves**

- Inspect each valve for wear, burn or distortion at its face and stem and, as necessary, replace it.
- Measure the thickness (2) of valve head. If the limit given to this thickness is exceeded, the valve must be replaced.

Valve head thickness (2)

Standard	Limit	
	0.8 - 1.2 mm (0.031 - 0.047 in.)	Inlet
	Exhaust	0.7 mm (0.0275 in.)

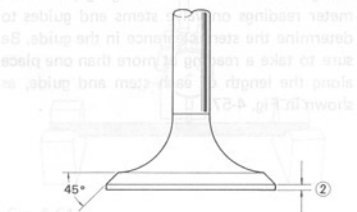


Fig. 4-62



- Check the end face of each valve stem for wear. This face meets the rocker arm intermittently in operation, and might become concaved or otherwise irregular. As necessary, smoothen the end face with an oil stone and, if this grinding removes the end stock by as much as 0.5 mm (0.0196 in.) (as measured from the original face), replace the valve.

Limit on stock allowance of valve stem end face	0.5 mm (0.0196 in.)
---	---------------------

Replacement valves have their stems machined to the following diameter ranges.

Standard valve stem diameter	Inlet	6.965 - 6.980 mm (0.2742 - 0.2748 in.)
	Exhaust	6.955 - 6.970 mm (0.2738 - 0.2744 in.)

- Check each valve for radial runout with a dial gauge and "V" block, as shown in Fig. 4-63. The object of this check is to determine whether the valve stem is true and square relative to the head.

Limit on valve head radial runout	0.03 mm (0.0012 in.)
-----------------------------------	----------------------

If the limit is exceeded, do not attempt to correct the stem; replace the valve, instead.

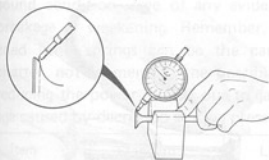


Fig. 4-63

#### Valve seats

##### CAUTION:

The valves to be checked and serviced for seating width and contact pattern must be those found satisfactory in regard to stem clearance in the guide and also the requirements stated in the preceding part titled VALVES.

- Seating contact width:

Produce a contact pattern on each valve in the usual manner, namely, by giving a uniform coat of Red-lead paste to the valve seat and by rotatingly tapping the seat with the valve head. The valve lapper (the tool used in valve lapping) must be used.

The pattern produced on the seating face of the valve must be a continuous ring without any break, and the width  $\text{W}$  of the pattern must be within the stated range.

Standard seating width $\text{W}$ revealed by contact pattern on valve face	Intake	1.3 - 1.5 mm (0.0512 - 0.0590 in.)
	Exhaust	

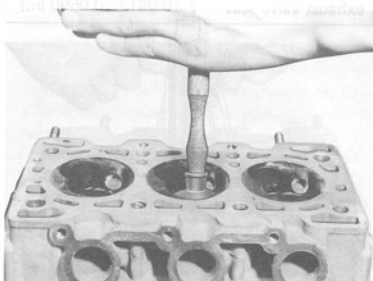


Fig. 4-64

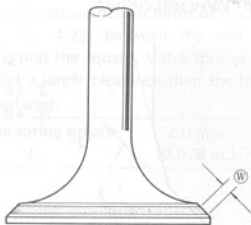


Fig. 4-65

Fig. 4-73

● Valve seat repair:

A valve seat not producing a uniform contact with its valve or showing a width  $\text{W}$  of the seating contact that is off the specified range must be repaired by regrinding or by cutting and regrinding and finished by lapping.

1) EXHAUST VALVE SEAT: Use a valve seat cutter to make three cuts in the order illustrated in Fig. 4-67. Three cutters must be used: the first for making the  $15^\circ$  angle, the second for making the  $75^\circ$  angle and the last for making the  $45^\circ$  seat angle. The third cut ③ must be made to produce the desired seat width  $\text{W}$ .

Seat width $\text{W}$ for exhaust valve seat	1.3 - 1.5 mm (0.0512 - 0.0590 in.)
--	---------------------------------------

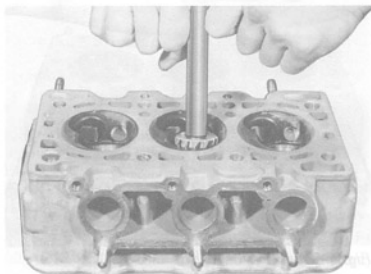


Fig. 4-66 Valve seat cutting

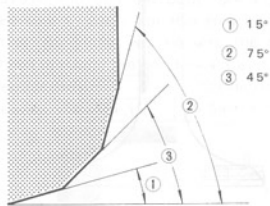


Fig. 4-67 Valve seat angles for exhaust valve seat

2) INLET VALVE SEAT: The cutting sequence is the same as for exhaust valve seats but the second angle differs, as will be noted in Fig. 4-68.

Seat width $\text{W}$ for inlet valve seat	1.3 - 1.5 mm (0.0512 - 0.0590 in.)
--	---------------------------------------

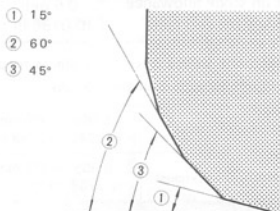


Fig. 4-68 Valve seat angles for inlet valve seat

3) VALVE LAPPING: Lap the valve on the seat in two steps, first with a coarse size lapping compound applied to the face and the second with a fine-size compound, each time using a valve lapper according to the usual lapping method.



Fig. 4-69 Applying lapping compound to valve face

**NOTES:**

- After lapping, wipe the compound off the valve face and seat, and produce a contact pattern with a red-lead paste. Check to be sure that the contact is centered widthwise on the valve seat and that there is no break in the contact pattern ring.
- Be sure to check and, as necessary, adjust the valve clearance after re-installing the cylinder head and valve mechanism.

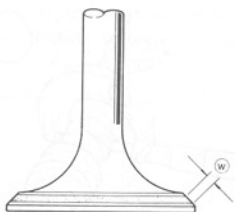


Fig. 4-70 Contact pattern  $\text{\textcircled{W}}$  uniform in width

**Valve springs**

- Referring to the criterion data given below, check to be sure that each spring is in sound condition, free of any evidence of breakage or weakening. Remember, weakened valve springs can be the cause of chatter, not to mention the possibility of reducing the power output due to gas leakage caused by decreased seating pressure.

Item	Standard	Limit
Valve spring free length	47.7 mm (1.8779 in.)	46.5 mm (1.8307 in.)
Valve spring preload	26 - 30 kg for 40 mm (57.3 - 66.1 lb/ 1.57 in.)	24 kg for 40 mm (52.9 lb/ 1.57 in.)

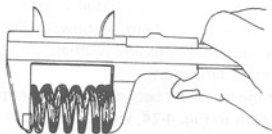


Fig. 4-71 Measuring free length of spring



Fig. 4-72 Checking the spring for preload

- Spring squareness:

Use a square and surface plate to check each spring for squareness in terms of the clearance  $\text{\textcircled{1}}$ , Fig. 4-73, between the end of valve spring and the square. Valve springs found to exhibit a larger clearance than the limit must be replaced.

Valve spring squareness $\text{\textcircled{1}}$	2.0 mm (0.079 in.)
--	-----------------------

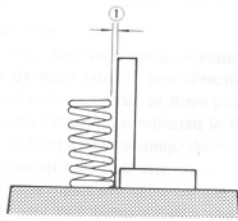


Fig. 4-73

## Camshaft

A noisy engine or an engine producing not enough power is frequently due to its camshaft excessively worn or bent or bowed. The wear could occur on its cams and journals.

### ● Camshaft deflection:

Hold the camshaft between two center points, as shown in Fig. 4-74, with a dial gauge rigged up to measure its deflection. Replace the camshaft if the amount of deflection so measured exceeds the limit.

Camshaft deflection limit	0.10 mm (0.0039 in.)
---------------------------	-------------------------

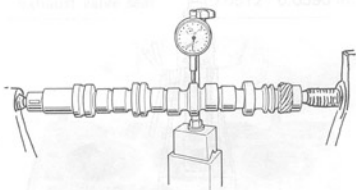


Fig. 4-74

### ● Cam wear:

Measure the height  $H$  of each cam. If any of the micrometer readings taken is down to or less than the limit, replace the camshaft.

Cam height $H$	Standard	Limit
Inlet cam	36.152 mm (1.4233 in.)	36.100 mm (1.4212 in.)
Exhaust cam	36.152 mm (1.4233 in.)	36.100 mm (1.4212 in.)
Pump drive cam	33.300 mm (1.3110 in.)	33.000 mm (1.2992 in.)

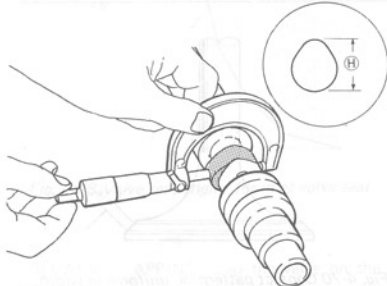


Fig. 4-75

### ● Thrust clearance:

Using a thickness gauge, measure this clearance as shown in Fig. 4-76, at the thrust plate. If the limit is exceeded, replace thrust plate or camshaft.

Item	Standard	Limit
Thrust clearance	0.050 - 0.150 mm (0.0019 - 0.0059 in.)	0.300 mm (0.0118 in.)

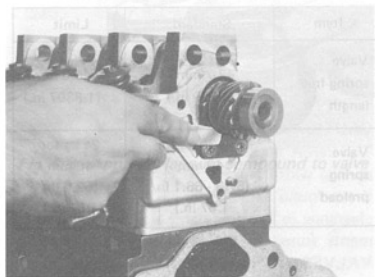


Fig. 4-76

● **Journal wear:**

Measure the journal diameter in two directions at four places to obtain four readings on each journal; and check the journal bores with a cylinder gauge, as shown in Fig. 4-78, producing four readings on each. From these readings, compute the radial clearance (camshaft journal clearance). If the service limit is exceeded by any of the computed radial clearances, replace the camshaft and, as necessary, cylinder head, too.

Item	Standard	Limit
Journal clearance	0.050 - 0.091 mm (0.0020 - 0.0036 in.)	0.15 mm (0.0059 in.)

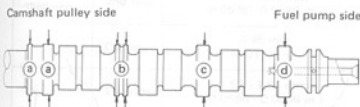


Fig. 4-77

Camshaft journal dia.	Journal bore dia.
a 43.425 - 43.450 mm (1.7096 - 1.7106 in.)	43.500 - 43.516 mm (1.7126 - 1.7132 in.)
b 43.625 - 43.650 mm (1.7175 - 1.7185 in.)	43.700 - 43.716 mm (1.7205 - 1.7210 in.)
c 43.825 - 43.850 mm (1.7254 - 1.7264 in.)	43.900 - 43.916 mm (1.7283 - 1.7289 in.)
d 44.025 - 44.050 mm (1.7332 - 1.7342 in.)	44.100 - 44.116 mm (1.7362 - 1.7368 in.)

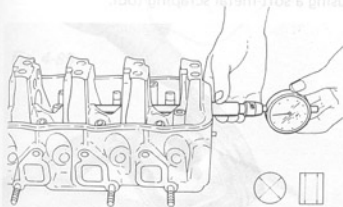


Fig. 4-78

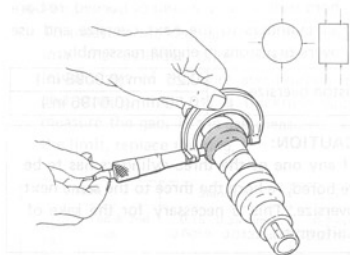


Fig. 4-79

● **Cylinder block**

● **Flatness of gasketed surface:**

By the same method that is prescribed for checking the flatness of the gasketed surface of the cylinder head, check the top face of the cylinder block for flatness and, if the flatness is found to exceed the limit, machine the face with a surface grinder.

Limit on flatness	0.05 mm(0.0020 in.)
-------------------	---------------------

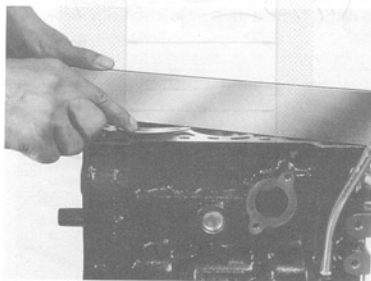


Fig. 4-80

● **Cylinder bore:**

Using a cylinder bore gauge, measure the diameter of each bore in two directions, longitudinal and transverse, at three places, top, middle and bottom, as indicated in Fig. 4-81, to obtain a total of 6 readings. On the basis of these readings taken on each bore, determine whether the maximum difference in diameter between any two bores exceeds the limit. If the limit, stated below, is exceeded or if the

bore wall is badly scored or burned, re-bore all cylinders to the next oversize and use oversize pistons in engine reassembly.

Piston oversize	0.25 mm (0.0098 in.)
	0.50 mm (0.0196 in.)

**CAUTION:**

If any one of the three cylinders has to be re-bored, re-bore the three to the same next oversize. This is necessary for the sake of uniformity.

When replacing the pistons or installing oversize pistons, be sure that the piston-to-cylinder clearance comes within the stated range:

Wear limit on bore	0.05 mm (0.0020 in.)
--------------------	-------------------------

Piston-to-cylinder clearance	0.040 - 0.050 mm (0.0016 - 0.0020 in.)
------------------------------	---

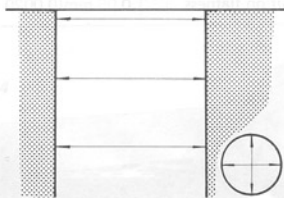


Fig. 4-81

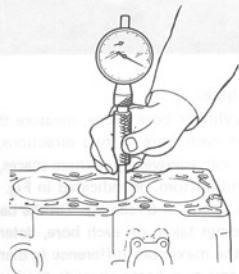


Fig. 4-82

**Piston and piston rings**

● **Piston diameter:**

Piston-to-cylinder clearance, mentioned above, is equal to the bore diameter minus the piston diameter, which is to be measured by measuring at the level of the piston in the direction transverse to piston pin axis, as shown in Fig. 4-83. This level (H) from the skirt end is 30 mm (1.18 in.) high.

Piston diameter	Standard	61.960 - 61.975 mm (2.4393 - 2.4399 in.)
	Oversize: 0.25 mm (0.0098 in.)	62.210 - 62.225 mm (2.4492 - 2.4498 in.)
	0.50 mm (0.0196 in.)	62.460 - 62.475 mm (2.4590 - 2.4596 in.)

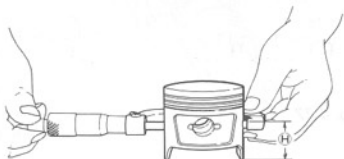


Fig. 4-83

- Inspect the outer surface of each cylinder for evidence of burn and for scratch or groove marks. Minor flaws can be removed by grinding with fine-grain sandpaper.
- De-carbon the piston crown and ring grooves, using a soft-metal scraping tool.

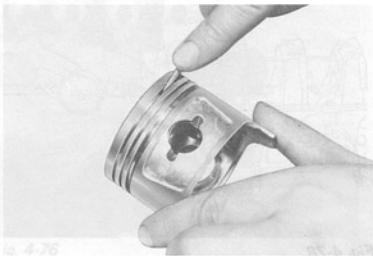


Fig. 4-84

● Ring clearance in the groove:

Using a thickness gauge, check each piston ring in its groove for side clearance and, if the limit stated below is exceeded, measure the groove width and ring width to determine whether the piston or the ring or both have to be replaced.

Item		Standard	Limit
Ring clearance in the groove	Top ring	0.03 - 0.07 mm (0.0012 - 0.0027 in.)	0.12 mm (0.0047 in.)
	2nd ring	0.02 - 0.06 mm (0.0008 - 0.0023 in.)	0.10 mm (0.0039 in.)

Piston ring thickness	Top ring	1.47 - 1.49 mm (0.0578 - 0.0586 in.)
	2nd ring	1.47 - 1.49 mm (0.0578 - 0.0586 in.)
	Oil ring	0.45 mm (0.0177 in.)
Ring groove width	Top ring	1.52 - 1.54 mm (0.0598 - 0.0606 in.)
	2nd ring	1.51 - 1.53 mm (0.0594 - 0.0602 in.)
	Oil ring	2.81 - 2.83 mm (0.1106 - 0.1114 in.)

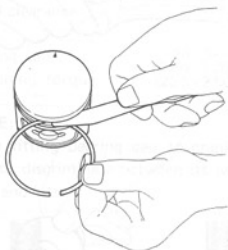


Fig. 4-85

● Piston ring end gap:

To measure the end gap, insert the piston ring into the cylinder bore, locating it at the lowest part of the bore and holding it true and square; then use a thickness gauge to measure the gap. If the gap measured exceeds the limit, replace the ring.

Item		Standard	Limit
Piston ring end gap	Top & 2nd rings	0.15 - 0.35 mm (0.0059 - 0.0137 in.)	0.7 mm (0.0275 in.)
	Oil ring	0.30 - 0.90 mm (0.0118 - 0.0354 in.)	1.8 mm (0.0708 in.)

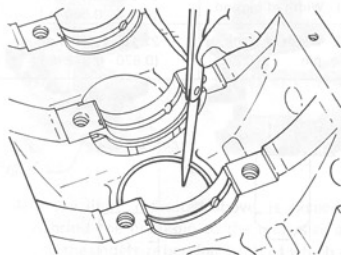


Fig. 4-86

### Connecting rods

#### ● Big-end thrust clearance:

Check the big end of each connecting rod for thrust clearance, with the rod fitted and connected to its crank pin in the normal manner. If the clearance measured is found to exceed the limit, the connecting rod or the crankshaft, whichever is responsible for the excessive clearance, must be replaced.

Item	Standard	Limit
Big-end thrust clearance	0.10 - 0.20 mm (0.0039 - 0.0078 in.)	0.30 mm (0.0118 in.)

① Width of big end	21.95 - 22.00 mm (0.864 - 0.866 in.)
② Width of crank pin	22.10 - 22.15 mm (0.870 - 0.872 in.)

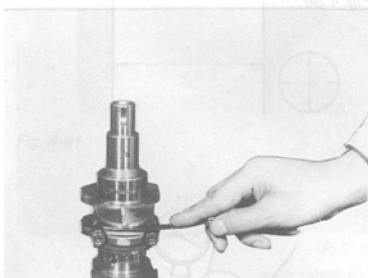
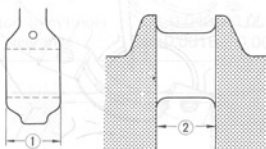


Fig. 4-87

#### ● Connecting rod alignment:

Mount the connecting rod on the aligner to check it for bow and twist and, if the limit is exceeded, replace it.

Limit on bow	0.05 mm (0.0020 in.)
Limit on twist	0.10 mm (0.0039 in.)

- Inspect the small end of each connecting rod for wear and evidence of crack or any other damage, paying particular attention to the condition of its bush. Check the piston pin clearance in the small end. Replace the connecting rod if its small end is badly worn or damaged or if the clearance checked exceeds the limit.

Item	Standard	Limit
Pin clearance in small end	0.003 - 0.016 mm (0.0001 - 0.0006 in.)	0.05 mm (0.0020 in.)

Small-end I.D.	16.003 - 16.011 mm (0.6300 - 0.6303 in.)
Piston pin dia.	15.995 - 16.000 mm (0.6297 - 0.6299 in.)

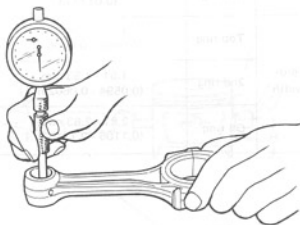


Fig. 4-88

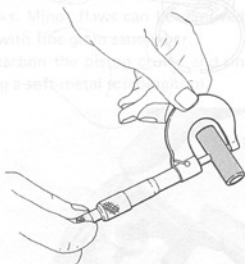


Fig. 4-89



### Connecting-rod big end bearings

- Inspect the bearing shells for signs of fusion, pitting, burn or flaking and observe the contact pattern. Bearings found in defective condition through this inspection must be replaced.

#### CAUTION:

Bearing shells are not meant to be repaired by scraping or grinding with sandpaper or by any machining. The remedy is to replace them.

- Crankpin-to-bearing clearance:**  
Check this clearance by using fuse stock or, preferably, PLASTIGAGE. Here's how to use PLASTIGAGE:  
1) Prepare, by cutting, a length of PLASTIGAGE roughly equal to bearing width and place it axially on crankpin, avoiding the oil hole.  
2) Make up the big end in the normal manner, with bearing shells in place and by tightening the cap to the specification.

#### NOTE:

Never rotate crankshaft or turn connecting rod when a piece of PLASTIGAGE is in the radial clearance.

Bearing cap tightening torque	28 - 32 N.m 2.80 - 3.20 kg-m (20.5 - 23.0 lb-ft)
-------------------------------	--

#### NOTE:

When fitting bearing cap to crankpin, be sure to discriminate between its two ends, right and left.

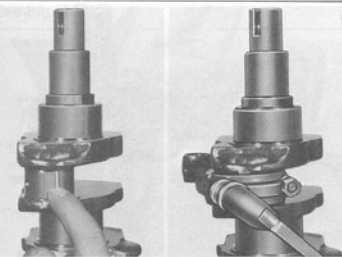


Fig. 4-90

Fig. 4-91

- Remove the cap, and measure the width of flattened PLASTIGAGE piece with the PLASTIGAGE envelope scale. This measurement must be taken at the widest part.

Item	Standard	Limit
Crankpin-to-bearing clearance	0.020 - 0.040 mm (0.0008 - 0.0016 in.)	0.080 mm (0.0031 in.)

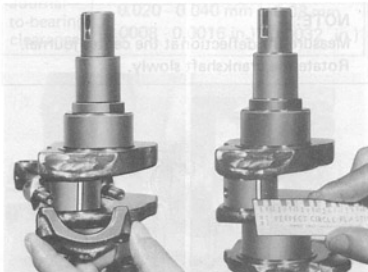


Fig. 4-91

- If the limit, indicated above, is exceeded, re-grind the crankpin to the undersize and use the undersize bearing, both of which are stated below:

Bearing size	Crankpin diameter
Standard	37.985 - 38.000 mm (1.4954 - 1.4960 in.)
0.25 mm (0.0098 in.) undersize	37.735 - 37.750 mm (1.4856 - 1.4862 in.)
0.50 mm (0.0196 in.) undersize	37.485 - 37.500 mm (1.4760 - 1.4763 in.)

Where undersize bearings are used, the clearance specification is slightly lenient:

Radial clearance for undersize bearing	0.020 - 0.070 mm (0.0008 - 0.0027 in.)
--	---

## Crankshaft

- Deflection:

Check the crankshaft for deflection, as shown in Fig. 4-92, and if the dial gauge reading exceeds the limit, repair or replace the crankshaft.

Limit on crankshaft deflection	0.06 mm (0.0023 in.)
--------------------------------	-------------------------

**NOTE:**

Measure the deflection at the center journal. Rotate the crankshaft slowly.

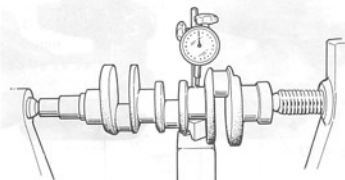


Fig. 4-92

- Crankshaft thrust play:

Measure this play with crankshaft set in the cylinder block in the normal manner, that is, with the thrust bearing fitted and the bearing caps installed. Use a dial gauge to read the displacement in axial (thrust) direction of the crankshaft. If the limit is exceeded, replace the existing thrust bearing by the oversize one.

Item	Standard	Limit
Crankshaft thrust play	0.13 - 0.28 mm (0.0051 - 0.0110 in.)	0.35 mm (0.0138 in.)

Thickness of crankshaft thrust bearing	Standard	2.500 mm (0.0984 in.)
	Oversize 0.125 mm (0.0049 in.)	2.563 mm (0.1009 in.)
	Oversize 0.250 mm (0.0098 in.)	2.625 mm (0.1033 in.)

Tightening torque for cap bolts	55 - 60 N.m 5.50 - 6.00 kg-m (40.0 - 43.0 lb-ft)
---------------------------------	--

Tightening torque for the bolts securing the bearing caps is specified.

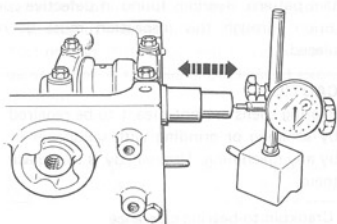


Fig. 4-93

- Out-of-round and taper (uneven wear):

An unevenly worn crankshaft journal or crankpin shows up as a difference in diameter at a cross section or along its length (or both). This difference, if any, is to be determined from micrometer readings taken as shown in Fig. 4-94.

If any of the journals or crankpins is badly damaged or if the amount of uneven wear in the sense explained above exceeds the limit, repair (by re-grinding) or replace the crankshaft.

Limit on uneven wear	0.01 mm (0.0004 in.)
----------------------	----------------------

**NOTE:**

Where journal or crankpin re-grinding is necessary, finish the diameter to the size necessary for the undersize bearing. (Refer to page 4-31)

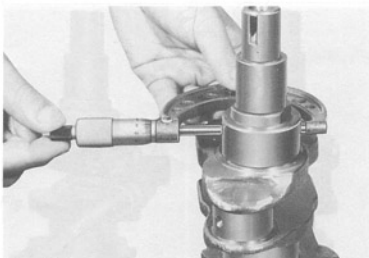


Fig. 4-94

### Crankshaft journal bearings

- Inspect the bearing shells for signs of fusion, pitting, burn or flaking and observe the contact pattern. Defective shells must be replaced.

#### CAUTION:

As in the case of connecting-rod bearings, the journal bearing shells are not meant to be repaired by scraping or grinding with sandpaper or by any machining.

- Journal-to-bearing clearance:

Check this clearance by using fuse stock or, preferably, PLASTIGAGE. The following method is based on the use of PLASTIGAGE:

- Cut the PLASTIGAGE stock to the required length (equal to the width of the bearing), and place it axially on the journal, avoiding the oil hole.
- Mount the crankshaft in the usual manner, tightening the bearing caps to the specified torque value. (It is assumed that a PLASTIGAGE piece is pinched at each journal.) Do not rotate the crankshaft when PLASTIGAGE is in.

Tightening torque for cap bolts	55 - 60 N.m 5.50 - 6.00 kg-m (40.0 - 43.0 lb-ft)
---------------------------------	--

#### CAUTION:

Each of the four bearing caps has an arrow marked on it. Be sure to position each cap with its arrow pointing to crankshaft pulley side and to match it (by the cylinder number) to its journal. Remember, the three cylinders are numbered, 1, 2 and 3, as counted from crankshaft pulley side. See Fig. 4-95.

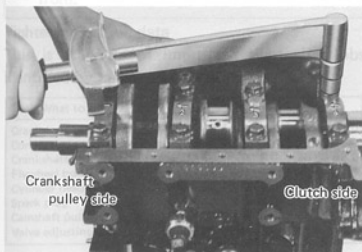


Fig. 4-95

- Remove the caps and take out the PLASTIGAGE pieces, which are now flattened. By referring to the envelop scale, measure the width of the widest part of the piece, and determine whether the radial clearance checked (obtained from the PLASTIGAGE piece) is within the limit.

Item	Standard	Limit
Journal-to-bearing clearance	0.020 - 0.040 mm (0.0008 - 0.0016 in.)	0.08 mm (0.0032 in.)

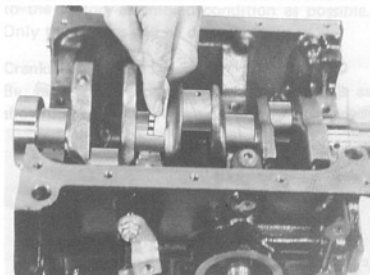


Fig. 4-96

- If the limit is exceeded, re-grind the journals to the undersize and use the undersize bearing.

Bearing size	Journal diameter
Standard	39.982 - 40.000 mm (1.5741 - 1.5748 in.)
0.25-mm undersize (0.0098 in.)	39.732 - 39.750 mm (1.5642 - 1.5650 in.)
0.50 mm undersize (0.0196 in.)	39.482 - 39.500 mm (1.5545 - 1.5552 in.)

Radial clearance for undersize bearing	0.020 - 0.070 mm (0.0008 - 0.0027 in.)
--	---

### Flywheel

- Inspect the friction surface—the surface in contact with clutch disc—for wear and damage. Most of surface flaws, if any, can be removed by simple machining. A badly damaged flywheel must be replaced.
- Face runout:  
Check the flywheel for face runout with a dial gauge, as shown in Fig. 4-97. Be sure that the runout is within the limit.

Limit on runout	0.2 mm (0.0078 in.)
-----------------	---------------------

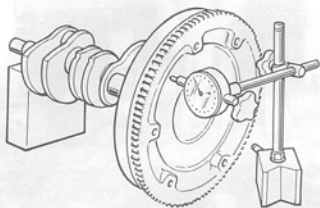


Fig. 4-97

- Ring gear tooth wear:  
Inspect the teeth for wear and for evidence of crack, chipping or any other damage. Replace the ring gear if its teeth are found in bad condition.

### Oil seals

Carefully inspect the oil seals removed in disassembly, examining the lip portion ① of each oil seal for wear and damage. Use of new oil seals in reassembly is recommended.



Fig. 4-98

### Timing belt and timing pulleys

Inspect the belt and pulleys for wear, cracks and signs of failure. Replace them as necessary.

#### CAUTION:

- Do not bend the belt. Keep away oil and water from the belt. The belt must be kept clean.
- The pulleys and belt tensioner, too, must be kept clean and free of oil and water.

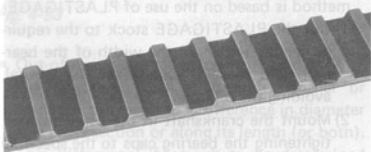


Fig. 4-99

## 4-6. Engine Reassembly

### NOTE:

- All parts to be used in reassembly must be perfectly clean.
- Oil the sliding and rubbing surfaces of engine parts just before using them in reassembly. Use engine oil (Refer to page 1-14).
- Have the liquid packing ready for use. SUZUKI BOND No.4 is specified for the liquid. Use it wherever its use is specified in order to ensure leak-free (oil and water) workmanship of reassembly.
- There are many running clearances. During the course of engine reassembly, be sure to check these clearances, one after another, as they form.
- Gaskets, "O" rings and similar sealing members must be in perfect condition. For these members, use replacement parts in stock.
- Tightening torque is specified for important fasteners-bolts and nuts in the main- of the engine and other components. Use torque wrenches and constantly refer to the specified values given in the text of this manual. The list immediately following is such specifications.
- Do not disregard the match marks provided on parts. Some of them are those given at the time of disassembly.
- There are many sets of parts. Crankshaft bearings, connecting rods, pistons, etc., are in combination sets. Do not disturb the combinations and try to see that each part goes back to where it came from.

### Tightening torque data

This is a list-up of important tightening jobs identified by parts to be secured:

What to tighten	N.m	Kg-m	lb-ft
Crankshaft bearing cap bolt	55 - 60	5.5 - 6.0	40.0 - 43.0
Connecting-rod bearing nut	28 - 32	2.8 - 3.2	20.5 - 23.0
Crankshaft pulley bolt	50 - 60	5.0 - 6.0	36.5 - 43.0
Flywheel bolt	40 - 45	4.0 - 4.5	29.0 - 32.5
Cylinder head bolt	55 - 60	5.5 - 6.0	40.0 - 43.0
Spark plug	20 - 30	2.0 - 3.0	14.5 - 21.5
Camshaft pulley bolt	50 - 60	5.0 - 6.0	36.5 - 43.0
Valve adjusting nut	15 - 20	1.5 - 2.0	11.0 - 14.0

What to tighten	N.m	kg-m	lb-ft
Oil drain plug	20 - 25	2.0 - 2.5	14.5 - 18.0
Oil pan securing bolt	4 - 5	0.4 - 0.5	3.0 - 3.5
Oil filter	10 - 15	1.0 - 1.5	7.5 - 10.5
Oil filter stand	20 - 25	2.0 - 2.5	14.5 - 18.0
Oil pressure unit	12 - 15	1.2 - 1.5	9.0 - 10.5
Timing belt cover bolt	3 - 4	0.3 - 0.4	2.5
Cylinder head cover bolt	4 - 5	0.4 - 0.5	3.0 - 3.5
Rocker arm shaft screw	9 - 12	0.9 - 1.2	7.0 - 8.5
Camshaft thrust plate screw	9 - 12	0.9 - 1.2	7.0 - 8.5

Engine reassembly is the reverse of engine disassembly as far as sequence is concerned, but there are many reassembling steps that involve measures necessary for restoring the engine as close to the factory-assembled condition as possible. Only those steps will be dealt with.

### Crankshaft

Be sure to oil crankshaft journal bearings as shown.

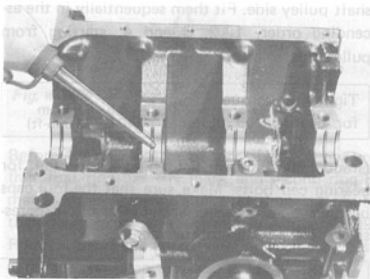


Fig. 4-100

Thrust bearings for the crankshaft are an item prone to escape the serviceman's attention: be careful not to leave them out. These bearings go into place with their oil groove side facing the crank web.

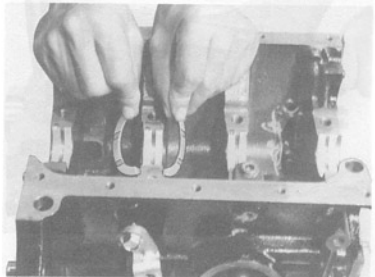


Fig. 4-101

Be sure to oil crankshaft journals as shown.

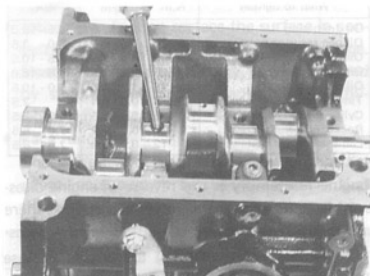


Fig. 4-102

When fitting crankshaft bearing caps to journals after setting the crankshaft in place, be sure to point the arrow mark (on each cap) to crankshaft pulley side. Fit them sequentially in the ascending order, 1, 2, 3 and 4, starting from pulley side.

Tightening torque	55 - 60 N.m
for bearing cap bolts	5.5 - 6.0 kg-m (40.0 - 43.0 lb-ft)

Gradual and uniform tightening is important for bearing cap bolts. Make sure that the four caps become tight equally and uniformly progressively to the stated torque value.

**NOTE:**

After tightening cap bolts, check to be sure that crankshaft rotates smoothly when turned over by hand.

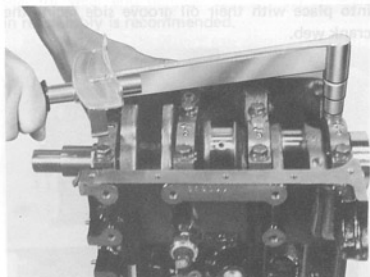


Fig. 4-103

**Oil seal housing**

This housing demands a new gasket: do not reuse the gasket removed in disassembly. After bolting the housing to the block, the gasket edges might bulge out; if so, cut off the edges to make the joint seam flat and smooth: use a sharp knife. After cutting, apply SUZUKI BOND No.4, as shown.

**NOTE:**

Just before mounting the housing, oil the lip portion of the oil seal.

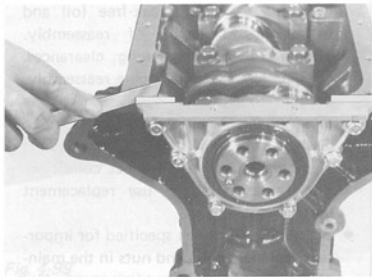


Fig. 4-104

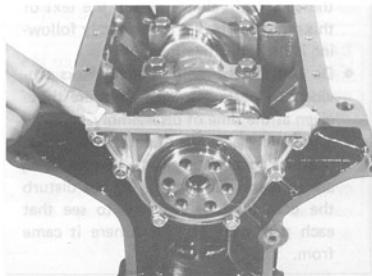


Fig. 4-105

### Oil pump

The gasket for oil pump case must be new. As in the case of oil seal housing, cut off the gasket edges with a knife to smoothen the joint seam.

#### NOTE:

Before fitting the pump case, oil the oil seal lip.

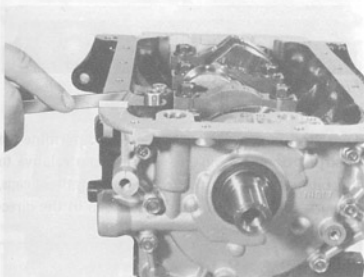


Fig. 4-106

After cutting the gasket edges, apply SUZUKI BOND No. 4.

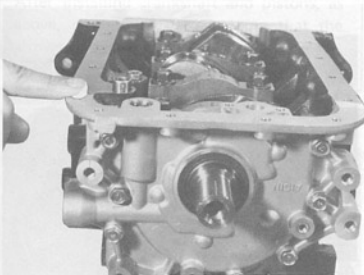


Fig. 4-107

### Piston and piston rings

**POSITION OF PISTON RELATIVE TO CONNECTING ROD:** The arrow ① on the crown points to crankshaft pulley side, and the oil hole ② comes on inlet port side. See Fig. 4-108.

#### NOTE:

Before pinning piston to connecting rod, oil the small end and pin holes.

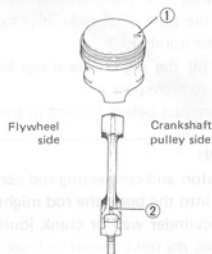


Fig. 4-108

Before fitting rings to piston, check to be sure that first ring has RN mark and second ring R mark. After mounting the three rings, distribute their end gaps as illustrated in Fig. 4-109. Remember, the marked side of each ring (1st and 2nd) comes on top side.

#### NOTE:

After fitting the rings, oil them in the grooves.

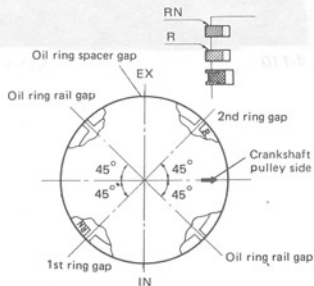


Fig. 4-109

Use of the piston ring compressor **A** (09916-77310), Fig. 4-110, is mandatory in inserting pistons into cylinder block. Using this compressor **A**, feed the piston and connecting rod combination into the bore from the upper side of cylinder block.

Pay attention to these reminders:

- Point the piston crown arrow to pulley side.
- Be sure that the number (marked on the crown at the time of disassembly) tallies with the cylinder number.
- Liberally oil the big-end bearings before fitting them to crankpins.
- Oil the bore just before feeding in the piston.

**CAUTION:**

As the piston and connecting rod combination goes into the bore, the rod might hitch onto the cylinder wall or crank journal. In such a case, do not attempt to force piston in. If any hitch is felt, look into under crankshaft to clear the way for the rod.

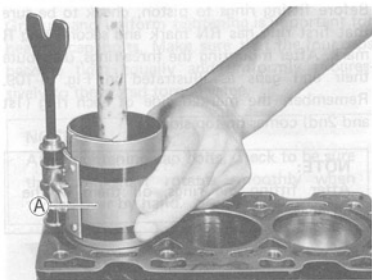


Fig. 4-110

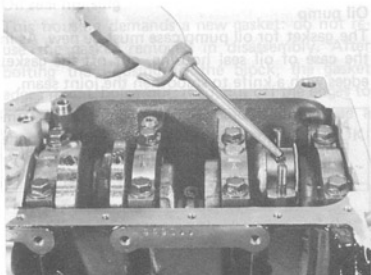


Fig. 4-111

**Connecting rods**

Two stoppers **1** **2**, Fig. 4-113 determine the position of each big-end bearing cap relative to the big end. At the time of installing these caps, be sure to locate stopper **1** of cap in the direction of stopper **2**.

**NOTE:**

The two stoppers do not coincide in longitudinal direction: the coincidence is meant in the direction shown in Figs. 4-112 and 4-113.

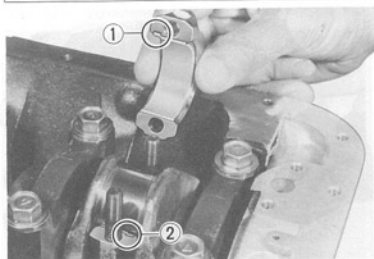


Fig. 4-112

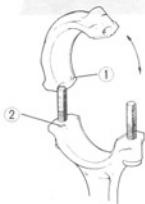


Fig. 4-113



After fitting all three big-end bearing caps, start tightening them uniformly, being sure to equalize tightness between right and left on each cap. The sequence here is similar to that for crankshaft bearing caps.

Tightening torque for big-end caps	28 - 32 N.m 2.8 - 3.2 kg-m (20.5 - 23.0 lb-ft)
---------------------------------------	--

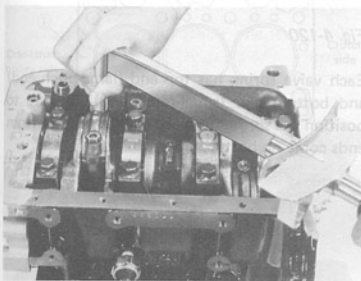


Fig. 4-114

**NOTE:**

After installing crankshaft and pistons, as above, double-check to be sure that the arrows on piston crowns are all pointing to crankshaft pulley side.

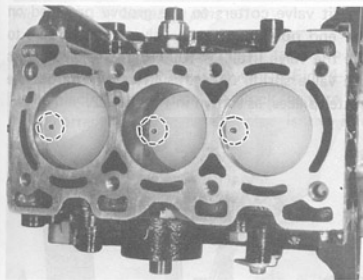


Fig. 4-115

**Oil pump strainer**

Bear in mind that "O" ring ① is often forgotten and left out in reassembly. Absence of this ring defeats the purpose served by the strainer.

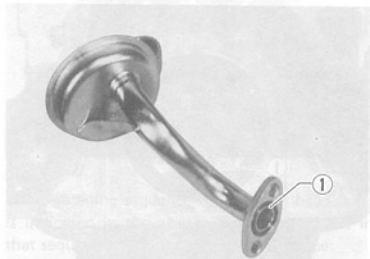


Fig. 4-116

**Oil pan**

After fitting the oil pan to the block, run in the securing bolts and start tightening at the center: move the wrench outward, tightening one bolt at a time.

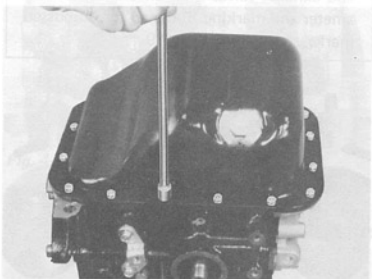


Fig. 4-117



Fig. 4-127

## Flywheel

The first step of flywheel installation is to check to be sure that locating pin ① is studded in the crankshaft.

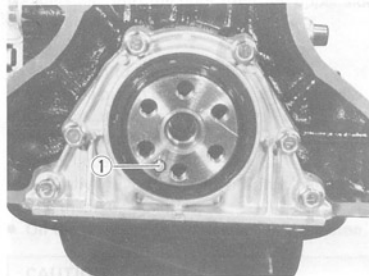


Fig. 4-118

## Cylinder head

Oil valve stems before inserting them into guides.

### CAUTION:

Be sure to distinguish between inlet valves and exhaust valves. The difference is in diameter and marking. Refer to the embossed marks, shown in Fig. 4-119.

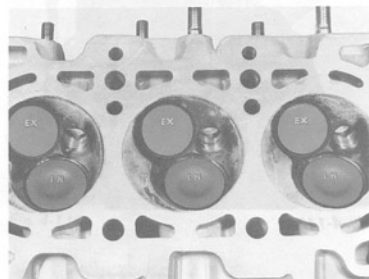


Fig. 4-119

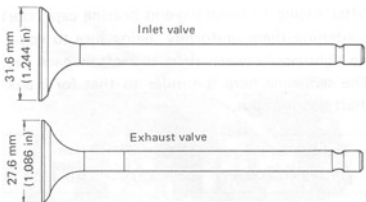


Fig. 4-120

Each valve spring has top end (large-pitch end) and bottom end (small-pitch end). Be sure to position the springs in place so that their bottom ends come on bottom side.



Fig. 4-121

To fit valve cotters to the groove provided on the end portion of each valve stem, be sure to use the valve lifter (A) (09916-14510): compress the valve spring with this lifter and mount the cotter pieces, as shown in Fig. 4-122.

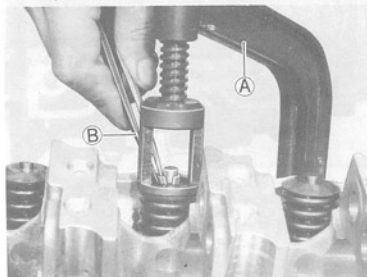


Fig. 4-122 B Forceps (09916-84510)

At the time of installing the cylinder head, be sure to position the head gasket correctly on the cylinder block. "TOP" mark ①, provided on the gasket, comes on top side, "IN" mark ② comes on inlet manifold side and "EX" mark comes on exhaust side.

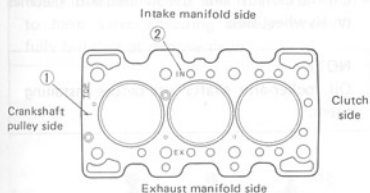


Fig. 4-123

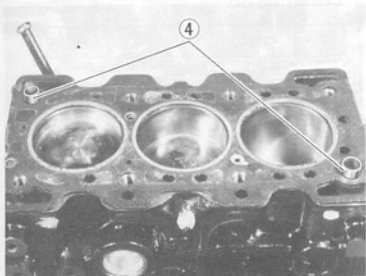


Fig. 4-124 ④ Locating pins

The position the cylinder head takes on the block is but one, which is shown in Fig. 4-125. When placing the head on the block, be sure that it is correctly oriented: the clue is the inlet ports ⑤.

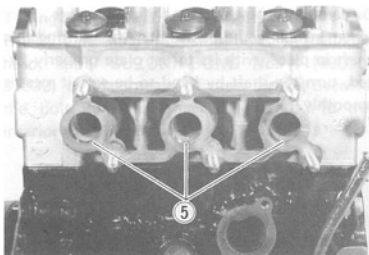


Fig. 4-125

The tightening sequence for cylinder head bolts is indicated in the photo. Tighten the bolts in that sequence to the specified torque value:

Tightening torque for cylinder head bolts	55 - 60 N.m 5.5 - 6.0 kg-m (40.0 - 43.0 lb-ft)
---	--

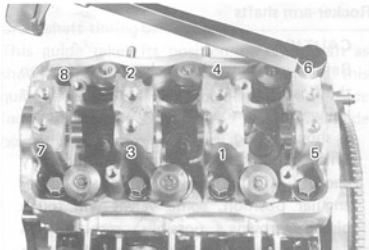


Fig. 4-126

#### Camshaft

The camshaft goes into cylinder head from distributor gear case side. Before inserting it, be sure to oil its journals.

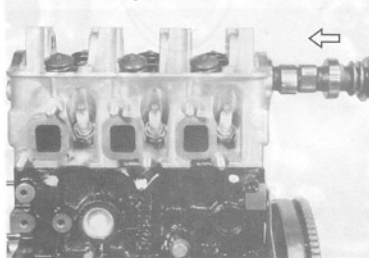


Fig. 4-127

Be careful not to leave out the thrust plate ① when installing the camshaft. After setting this shaft in place, with its thrust plate properly fitted, turn the shaft by hand to be sure it rotates smoothly.

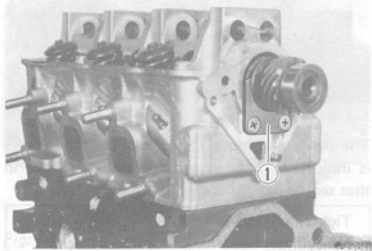


Fig. 4-128

#### Rocker-arm shafts

##### CAUTION:

Before installing the rocker-arm shaft on the head, be sure to locate the crankshaft keyway ② in the  $50^{\circ} - 70^{\circ}$  angular range, as shown in Fig. 4-129.

This crankshaft position is necessary because, if its keyway is in any other angular position, some valves will touch piston crowns, possibly resulting in damaged valves or piston crowns. Keep crankshaft in that angular position until the job of adjusting the timing belt tension is completed.

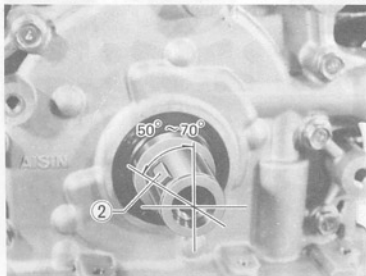


Fig. 4-129

The two rocker-arm shafts are identical, there being no need to distinguish between the two. However, each shaft takes but one position in place. See Fig. 4-130.

- On the inlet side, the stepped end ③ comes on camshaft pulley side.
- On the exhaust side, the stepped end ④ comes on flywheel side.

##### NOTE:

Oil rocker-arm shafts just before installing them.

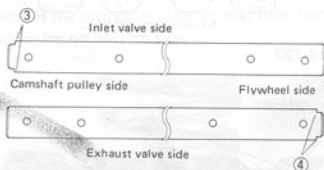


Fig. 4-130

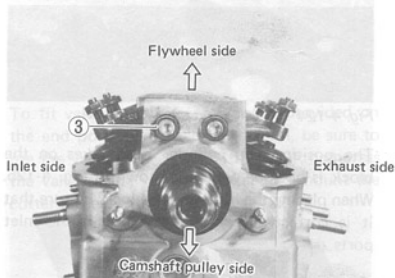


Fig. 4-131

As to the positions of rocker arms and springs on each rocker-arm shaft, refer to Fig. 4-132. "Camshaft pulley side" is meant by "1"; "distributor gear side" by "2".

**NOTE:**

When installing rocker-arm shafts, be sure to have valve adjusting screws loosened fully but do not remove them.

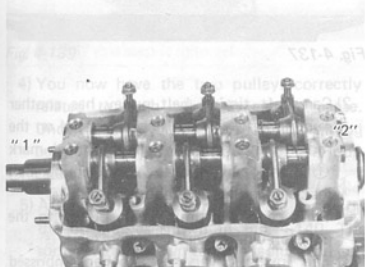


Fig. 4-132

**Water inlet pipe**

The angle that this pipe takes in place is important. When installing it, be sure to angle it as shown in Fig. 4-133.

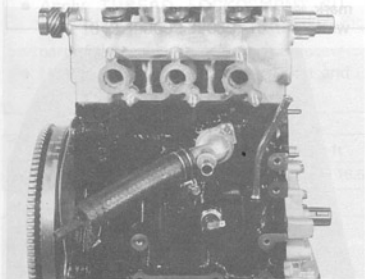


Fig. 4-133

**Timing belt inside cover stud bolts**

When reinstalling the stud bolts to cylinder head, apply SUZUKI BOND No. 4 (99000-31030) to the threads of these screws, because the bolt holes for the two extend into the interior of cylinder head.

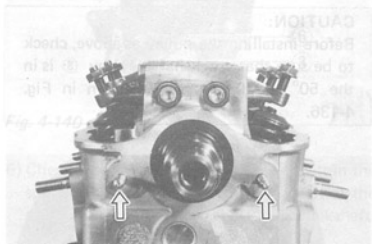


Fig. 4-134

**Crankshaft timing belt guide**

This guide takes its position on crankshaft as shown in Fig. 4-135. Remember, one side of this guide faces the cylinder block and the other side faces the timing belt pulley: the former side being distinct from the latter.

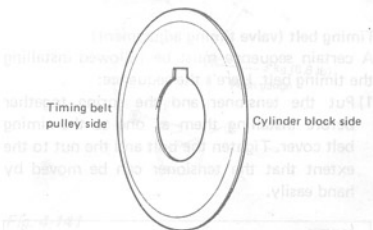


Fig. 4-135

weight line. If they do not line up straight, the foregoing procedure must be repeated to satisfy this requirement.

### Camshaft timing belt pulley

This pulley has a two-point mark ① to show that the marked side faces the timing belt outside cover. When installing the pulley, bring this mark on timing belt outside cover side and index it to the camshaft keyway ②. Secure the pulley in this position.

#### CAUTION:

Before installing the pulley as above, check to be sure that crankshaft keyway ③ is in the  $50^{\circ} - 70^{\circ}$  range, as shown in Fig. 4-136.

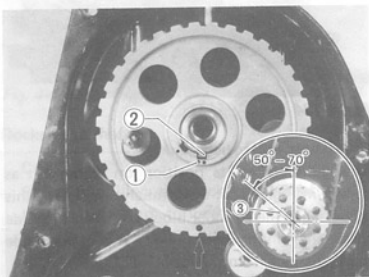


Fig. 4-136

### Timing belt (valve timing adjustment)

A certain sequence must be followed installing the timing belt. Here's the sequence:

- 1) Put the tensioner and the spring together before installing them as one to the timing belt cover. Tighten the bolt and the nut to the extent that the tensioner can be moved by hand easily.

#### NOTE:

When carrying out the above job, make sure to loosen each lock nut and then each valve clearance adjusting screw so that the camshaft and the pulley can rotate freely.

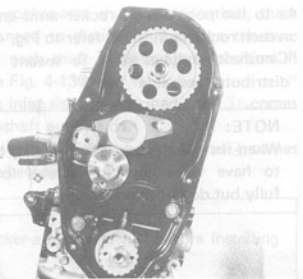


Fig. 4-137

- 2) Camshaft timing belt pulley has another punch-mark ④, which is located on the radial line passing through the punch-mark ① mentioned above. Now, timing belt inside cover has an embossed mark ⑤. Turn camshaft timing belt pulley to the position where mark ④ meets mark ⑤.
- 3) The inside cover has another embossed mark ⑥. Turn crankshaft to match keyway ③ of crankshaft timing belt pulley to mark ⑥.

#### CAUTION:

Never attempt to turn the crankshaft until mark ④ is indexed to mark ⑤.

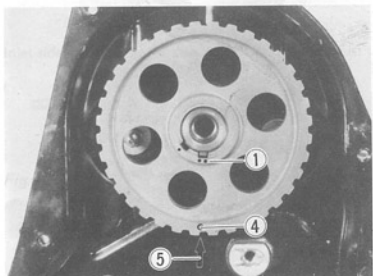


Fig. 4-138

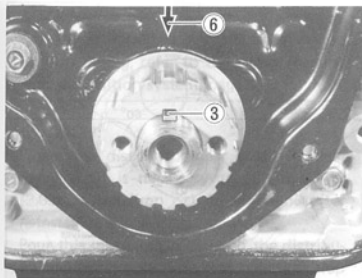


Fig. 4-139 This step is ignored.

4) You now have the two pulleys correctly related to each other in angular sense. Under this condition, put on the timing belt in such a way that portion of belt indicated as ⑦ is free of any slack.

5) After putting the belt, hook the spring on the bracket as shown in Fig. 4-140. The spring, with its own tension, adjust the belt tension to the specified value. Rotate the crankshaft clockwise fully twice and tighten the bolt and the nut to the specified torque.

**NOTE:**

- Apply **THREAD LOCKCEMENT SUPER 1342 (99000-32050)** to the screw part of the tensioner bolt.
- Make sure to tighten the bolt first and then the nut.

Tightening torque for tensioner bolt and nut	N.m	kg-m	lb-ft
	15 - 23	1.5 - 2.3	11.0 - 16.5

**CAUTION:**

After setting the belt tensioner, turn crankshaft 2 rotations in clockwise direction to see if marks ① ④ ⑤ ⑥ and crankshaft keyway ③ locate themselves on the same straight line. If they do not line up straight, the foregoing procedure must be repeated to satisfy this requirement.

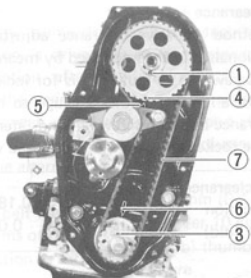


Fig. 4-140

6) Check to be sure that the tension is within the specified range when pushing the belt at the mid point between camshaft and crankshaft.

Timing belt tension "L"	5.5 - 6.5 mm (0.22 - 0.26 in.)
-------------------------	-----------------------------------

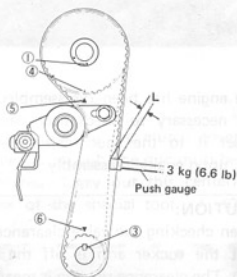


Fig. 4-141

7) After adjusting the belt tension within the specified range, adjust each valve clearance to the specified value.

### Valve clearance adjustment

The method of valve clearance adjustment is conventional. It is accomplished by means of adjusting screw (8). Nut (9) is for locking the screw. Use a feeler (thickness) gauge to measure the clearance between screw (8) and stem (10) when the rocker arm is turned up all the way.

Valve clearance specification (when cold)	Intake	0.13 - 0.18 mm
	Exhaust	(0.005 - 0.007 in.)

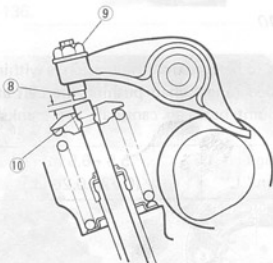


Fig. 4-142

If the engine has been disassembled, it is absolutely necessary to check each valve clearance and set it to the specification, as explained above, upon engine reassembly.

#### CAUTION:

When checking the valve clearance, be sure that the rocker arm is off the camshaft cam. The clearance reading is meaningless if the arm is riding on the cam. Stick to this rule for each valve.

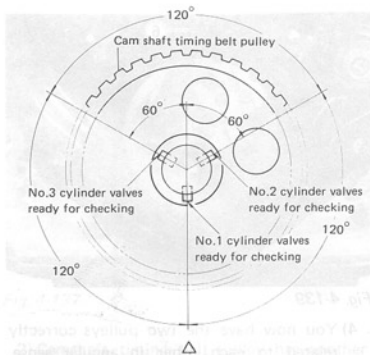


Fig. 4-143

### Distributor gear case

Bolts (1) are for securing this gear case to the cylinder block. When installing the case, be sure to apply SUZUKI BOND No. 4 (99000-31030) to the threads of these bolts.

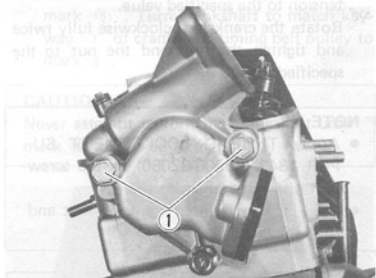


Fig. 4-144

### Distributor

The distributor takes its mounted position correctly only when it is inserted into the gear case under a specific condition. The condition is this: Turn over crankshaft to locate the piston at B.T.D.C. 10° (No. 1 Piston being compression stroke), and insert the distributor into the case, with center (2) of distributor rotor lined up with embossed mark (3) of distributor housing, as shown in Fig. 4-145.



**NOTE:**

For the checking and adjusting steps on ignition timing, refer to the section dealing with the ignition system, page 9-9.

**CAUTION:**

Where the distributor gear case has been removed, it is necessary to fill in 60 cc (2.03/2.11 US/Imp oz) of engine oil after re-installing the gear case.

Pour this much oil in through the distributor mounting hole. The gear could develop trouble if this step is ignored.



Fig. 4-145

**Water pump pulley**

Be sure to position the pulley as shown in Fig. 4-146.

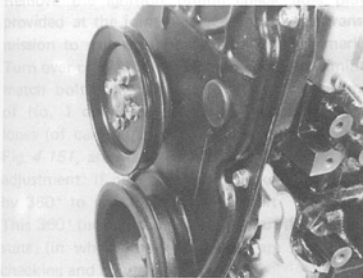


Fig. 4-146

**Alternator**

The water pump drive belt, by which the alternator too is driven, must be tensioned to the specification after the alternator is installed. Check the tension at the middle point of the belt between water pump pulley and alternator pulley. To vary the tension for adjustment, displace the alternator in place.

Drive belt tension  
(in terms of belt  
deflection as shown)

10 - 15mm (0.4 - 0.6  
in.) under 10 kg  
(22.0 lb) thumb  
pressure

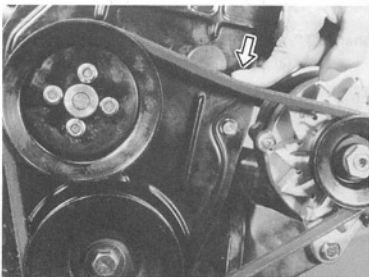


Fig. 4-147

**Clutch**

At the time of bolting the clutch cover after mounting the clutch disc, the disc must be trued up and centered. Carry out this centering job with the use of the special tool A (09923-37810).

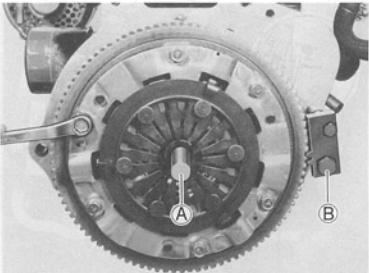


Fig. 4-148 B Flywheel stopper (09916-97820)

#### 4-7. Mounting the Engine

##### Engine mounting torque rod

Install the torque rod between the engine and the body using care for the following. Its improper installation may cause abnormal vibration and noise.

When tightening bolts ③, slide and adjust it in the ellipse holes ① so that the torque rod is right angle to bolt ②.

Tighten bolts ③ before tightening bolts ① and ②.

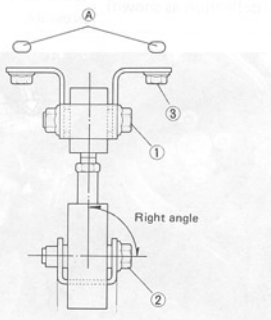


Fig. 4-149

Clearance "D" of each slit of the torque rod big rubber side should exceed 2 mm (0.079 in). If not, loosen nut B and adjust torque rod length "C" to obtain a correct clearance.

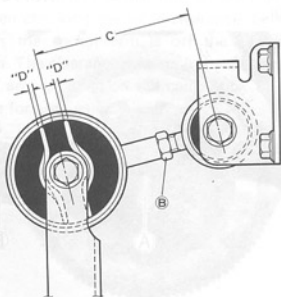
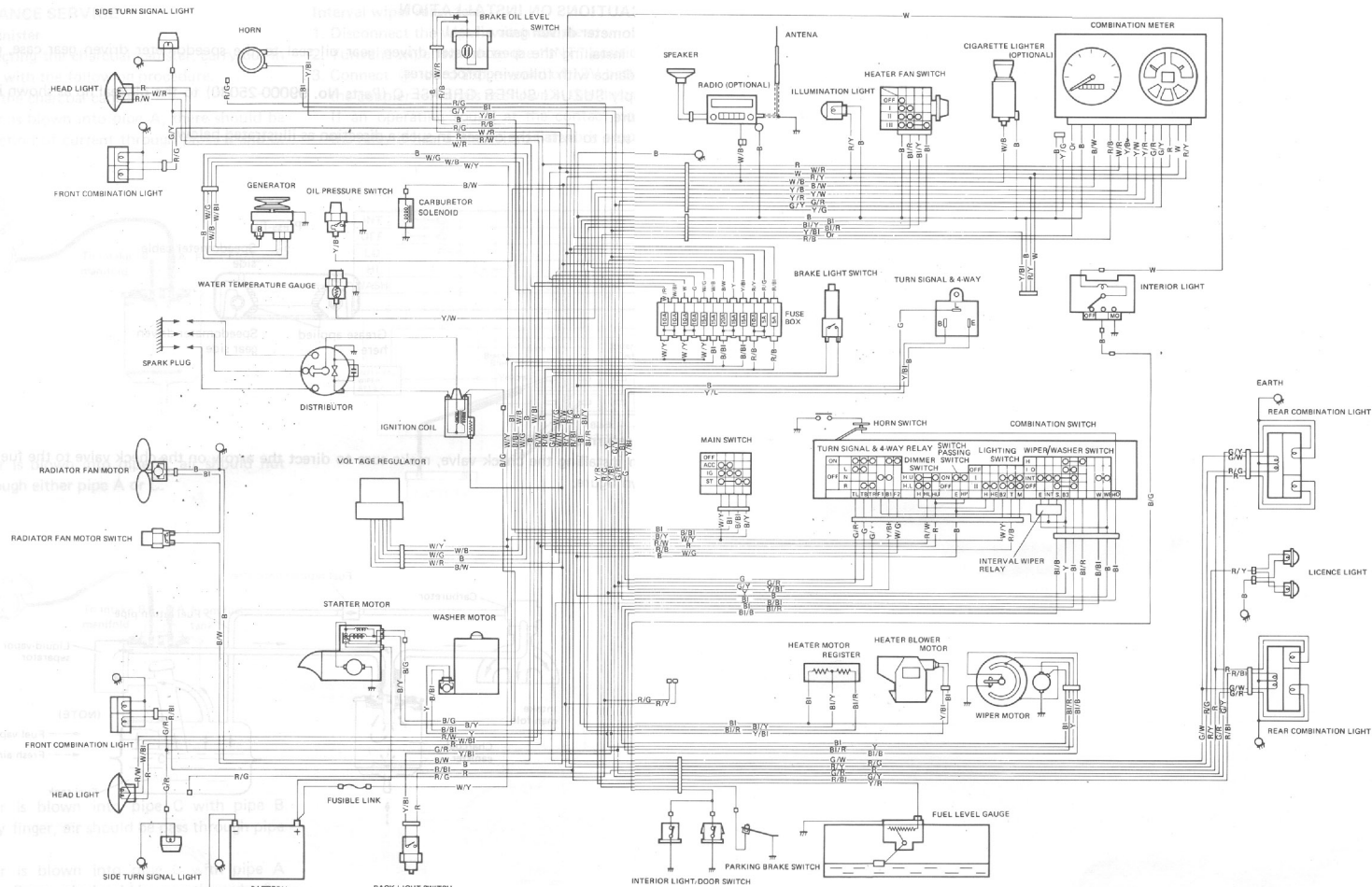


Fig. 4-150



**WIRE COLOR**

B	.....	Black	B/G	.....	Black with Green tracer	G/Y	.....	Green with Yellow tracer	W/G	.....	White with Green tracer
Bl	.....	Blue	B/W	.....	Black with White tracer	R/B	.....	Red with Black tracer	W/R	.....	White with Red tracer
G	.....	Green	BI/B	.....	Blue with Black tracer	R/Bl	.....	Red with Blue tracer	W/Y	.....	White with Yellow tracer
Or	.....	Orange	Bl/R	.....	Blue with Red tracer	R/G	.....	Red with Green tracer	Y/B	.....	Yellow with Black tracer
R	.....	Red	Bl/W	.....	Blue with White tracer	R/W	.....	Red with White tracer	Y/Bl	.....	Yellow with Blue tracer
W	.....	White	G/B	.....	Green with Black tracer	R/Y	.....	Red with Yellow tracer	Y/G	.....	Yellow with Green tracer
Y	.....	Yellow	G/R	.....	Green with Red tracer	W/B	.....	White with Black tracer	Y/R	.....	Yellow with Red tracer
B/Bl	.....	Black with Blue tracer	G/W	.....	Green with White tracer	W/Bl	.....	White with Blue tracer	Y/W	.....	Yellow with White tracer

## 4-8. Engine Inspection and Adjustments

### Water pump belt

Adjust the belt tension as outlined in the section for ENGINE COOLING SYSTEM (Page 7-8).

### Distributor point gap

The method of adjusting the contact point gap is described in the section for IGNITION SYSTEM (page 9-9).

### Ignition timing

Refer to IGNITION TIMING, Page 9-9.

### Carburetor

Adjustments to be made are detailed in Page 5-8.

### Valve clearance

Valve clearance specification (COLD)	Intake	0.13 - 0.18 mm (0.005 - 0.007 in.)
	Exhaust	

To check and adjust valve clearance with the engine mounted in place, that is, secured to the chassis, be sure to remove the cylinder head cover, so that you can take a good look at rocker arms and camshaft. Remember, a clearance reading is meaningful only when it is taken with the rocker arm clear of and not riding on the cam.

Remove the ignition timing check hole plug provided at the joint between engine and transmission to gain visual access to the "T" mark. Turn over crankshaft to index mark ① to timing match bolt ②, and see if the rocker arms of No. 1 cylinder are off the respective cam lobes (of camshaft); if so, valves ① and ②, Fig. 4-151, are ready for clearance checking and adjustment: if not, turn over crankshaft further by 360° to index mark ① to bolt ② again. This 360° turning should bring about the desired state. (in which the two valves are ready for checking and adjustment).

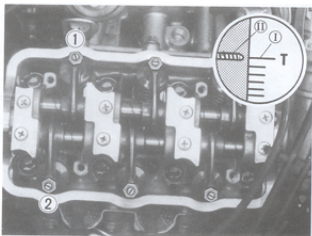


Fig. 4-151

Turn over the crankshaft 240° from "T" mark, check and adjust the valves ⑤ and ⑥.

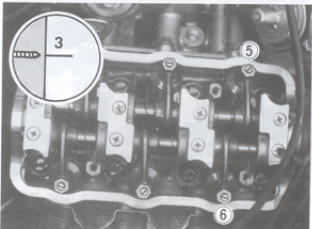


Fig. 4-152

Turn over the crankshaft 240° from "3" mark, check and adjust the valves ③ and ④.

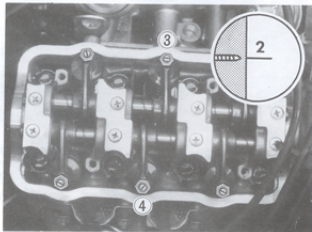


Fig. 4-153

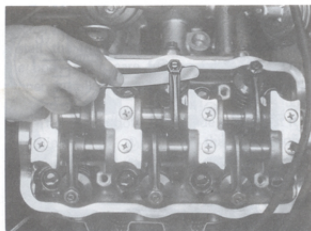


Fig. 4-154 Measuring valve clearance

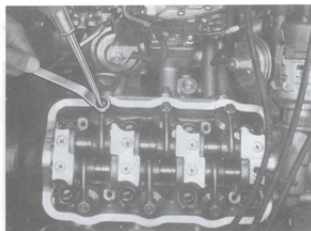


Fig. 4-155 Adjusting valve clearance

#### Timing belt

This belt must be inspected periodically, inspect it for cracks, cleanliness, oil stains and signs of breakage and replace the belt when necessary. Remove the inspection cap on the timing belt cover, and check the belt.



Fig. 4-156

#### Oil pump discharge pressure measurement

The method of pressure measurement is outlined in the section on ENGINE LUBRICATION (Page 4-54).

#### Compression pressure measurement

Check the compression pressure on all three cylinders, as follows:

- 1) Remove all spark plugs.
- 2) Install the compression gauge **A** (09915-64510) on one of the cylinders, making the connection perfectly air-tight.
- 3) Disengage the clutch (to lighten starting load on engine), and depress the accelerator all the way to make the throttle full-open.
- 4) Crank the engine with the starter motor, and read the highest pressure on the compression gauge.
- 5) Carry out the steps 2) through 4) on each cylinder to obtain three readings.

#### Compression pressure

Standard	Limit	Difference
13.5 kg/cm <sup>2</sup> (192.0 psi)/ 400 r/min	10.0 kg/cm <sup>2</sup> (142.2 psi)/ 400 r/min	1.0 kg/cm <sup>2</sup> (14.2 psi)/ 400 r/min between any two cylinders

#### NOTE:

There is some trouble in the engine when the compression pressure is not higher than the limit. Refer to TROUBLE-SHOOTING GUIDE (Page 3-3) for possible causes.

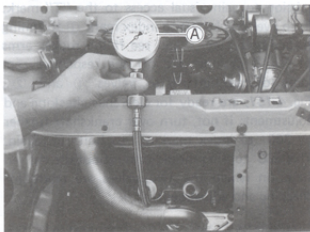


Fig. 4-157

**NOTE:**

The compression pressure value is measured by using the special tool (compression gauge 09915-64510).

**Vacuum measurement**

The vacuum that develops in the intake line is a good indicator of the condition of the engine.

It is for this reason that the vacuum is measured. The measuring procedure is as follows:

- 1) Run the engine until its coolant temperature rises to a level between 75° C and 85° C (167° F - 185° F).
- 2) Install the vacuum gauge (A) (09915-67310), as shown in Fig.4-158. Install an engine tachometer.
- 3) Run the engine at the specified idling speed and, under this running condition, read the vacuum gauge. The vacuum should be not lower than 40 cm Hg (15.7 in. Hg).

A low vacuum reading means that any combination of the following malconditions is the cause, which must be corrected before releasing the machine to the customer:

- (a) Leaky cylinder head gasket
- (b) Leaky inlet manifold gasket
- (c) Leaky valves
- (d) Weakened valve springs
- (e) Maladjusted valve clearance
- (f) Valve timing out of adjustment
- (g) Ignition mistimed
- (h) Carburetor improperly adjusted

**NOTE:**

Should the indicating hand of the vacuum gauge oscillate violently, turn the adjusting nut (B) to steady it.

Standard vacuum	40~ 45 cm Hg (15.7 ~ 17.7 in. Hg)
Idling speed specification	950 r/min (rpm) (Take vacuum reading at this speed.)

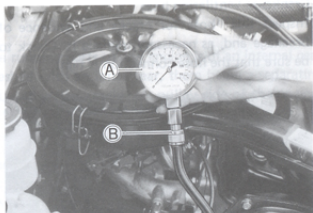


Fig. 4-158

**Engine oil**

Refer to the section for ENGINE LUBRICATION, Page 4-55.

**Engine oil filter**

The methods of checking and servicing the oil filter are outlined under ENGINE LUBRICATION, Page 4-54.

**Engine coolant**

This subject is covered in the section for ENGINE COOLING SYSTEM, Page 7-6.

**Exhaust line and muffler**

Inspect each exhaust line connection for tightness, and examine the muffler and other parts for evidence of breakage and leakage of gases. Repair or replace defective parts, if any.

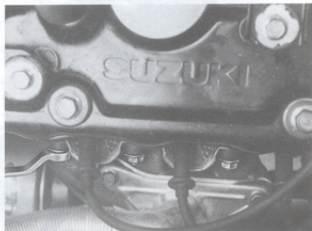


Fig. 4-159





## 4-9. Engine Lubrication

### Description

The oil pump for pressure-feeding lubrication oil to the running parts of the engine is of an internal gear type, in which an outer ring-like gear is internally meshed with an inner gear, there being a separating crescent-like stator between the two. The pump is mounted at the crankshaft pulley side of the engine, and is driven by the crankshaft.

### Oil Circuit:

The oil pump lifts oil through the strainer and discharges it under pressure, forcing the oil through the oil filter. The filtered oil flows into two paths inside the cylinder block. In one path, oil reaches the crankshaft journal bearings and big-end bearings on crankpins. Some of this oil goes to the connecting-rod small ends and lubricates piston pins there and also the walls of cylinder bores.

In the other path, oil goes up to the cylinder head through the camshaft No. 2 journal and enters the internal oilway of rocker arm shafts to lubricate the sliding parts of these shafts and rocker arms, and also other three journals of the camshaft.

An oil relief valve is provided on the oil pump. This valve starts relieving oil pressure when the pressure comes over about  $3.0 \text{ kg/cm}^2$  (42.7 psi). Relieved oil flows back to the oil pan.

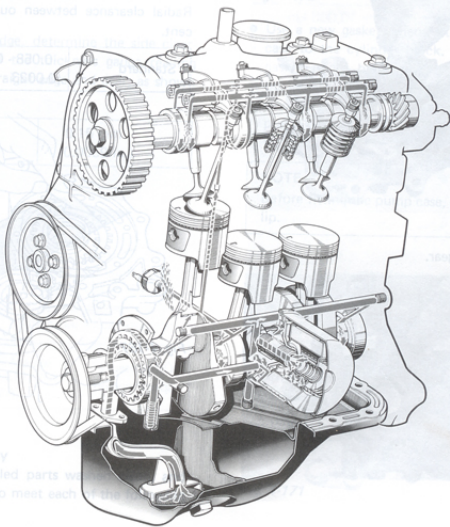


Fig. 4-162



### Oil pump disassembly

Remove oil pump gear plate.

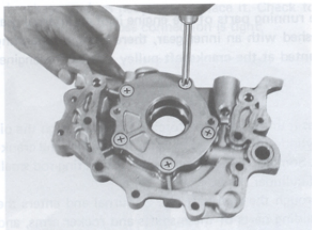


Fig. 4-163

Take out inner gear.

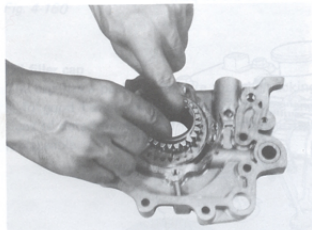


Fig. 4-164

Take out outer gear.

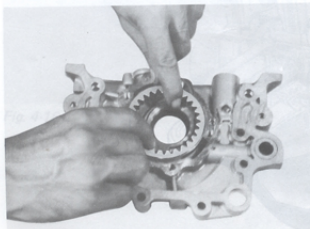


Fig. 4-165

### Oil pump inspection

Radial clearance between inner gear and crescent.

Standard	0.177 - 0.328 mm (0.0070 - 0.0129 in.)
----------	---

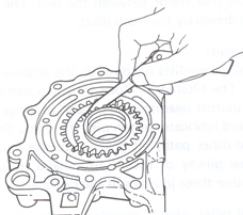


Fig. 4-166

Radial clearance between outer gear and crescent.

Standard	0.058 - 0.310 mm (0.0023 - 0.0122 in.)
----------	---

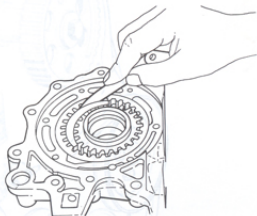


Fig. 4-167

Radial clearance between outer gear and pump case.

Standard	0.05 - 0.10 mm (0.0020 - 0.0039 in.)
----------	---

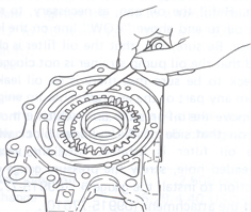


Fig. 4-168

**Side clearance:**

Using a straightedge, determine the side clearance in terms of the thickness gauge reading taken between straight edge and gear, as shown in Fig. 4-169.

Limit on side clearance	0.15 mm (0.0059 in.)
-------------------------	-------------------------

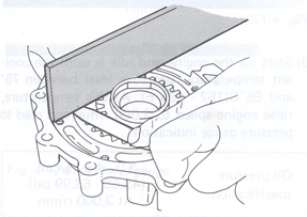


Fig. 4-169

**Oil pump reassembly**

Have all disassembled parts washed clean, and rebuild the pump to meet each of the following requirements:

When installing the gears in the case, apply the engine oil to each gear. After mounting the gear plate, check to be sure that each gear turns smoothly by hand.

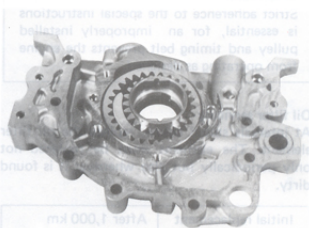


Fig. 4-170

- Use a new gasket when fitting the oil pump case to the cylinder block. The edge of the gasket might bulge out; if it does, cut the bulge off with a sharp knife, making the edge smooth and flush with the end face of the pump case, and apply SUZUKI BOND No. 4 to the cut edge.

**NOTE:**

Before fitting the pump case, oil the oil seal lip.

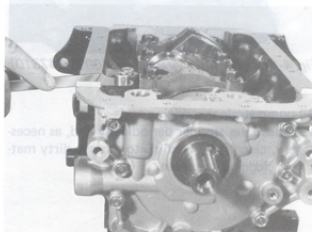


Fig. 4-171

- Installation of crankshaft timing belt pulley and timing belt must be carried out in strict conformity to the special instructions given in Page 4-42 for engine reassembly.

#### CAUTION:

Strict adherence to the special instructions is essential, for an improperly installed pulley and timing belt prevents the engine from operating as designed.

#### Oil filter servicing

At intervals stated below, replace the oil filter element. The element must be replaced not only periodically but also whenever it is found dirty.

Initial replacement to be made:	After 1,000 km (1,000 miles)
Replace at intervals of:	Every 10,000 km (6,000 miles)

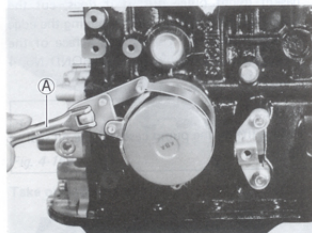


Fig. 4-172 Oil filter wrench (A) (09915-47310)

#### Oil pump strainer servicing

- Inspect the strainer periodically and, as necessary, clean it by washing to remove dirty matters clogging its screen.

#### Checking the oil pressure

When the engine is idling, not to mention fast running, the oil pressure light should remain completely off; if not, it is a cause for checking the oil pressure in the following manner:

- 1) Be sure that engine oil is up to level in the oil pan. Refill the oil pan, as necessary, to raise the oil to and above "LOW" line on the level gauge. Be sure, too, that the oil filter is clean and that the oil pump strainer is not clogged. Check to be sure that there is no oil leakage from any part of the engine.
- 2) Remove the oil pressure unit, which is mounted on that side of the cylinder block where the oil filter is located. Into the vacated threaded hole, screw the pressure gauge connection to install the gauge (09915-77310) and the attachment (09915-77610).

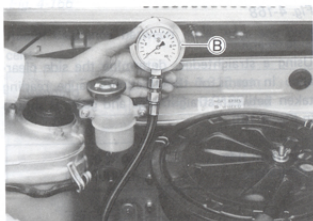


Fig. 4-173

- 3) Start up the engine and idle it until the coolant temperature rises to a level between 75° and 85°C (167° - 185°F). At this temperature, raise engine speed to 3,000 r/min and read to pressure gauge indication.

Oil pressure specification	3.0 - 4.5 kg/cm <sup>2</sup> (42.66 - 63.99 psi) At 3,000 r/min
----------------------------	---

If the pressure read is not up to the specification, the oil pump must be checked.

**CAUTION:**

When re-installing the oil pressure unit, be sure to wrap its screw threads with a sealing tape. Tighten the unit to a torque value of 12 to 15 N.m (1.2 - 1.5 kg-m, 9.0 - 10.5 lb-ft).

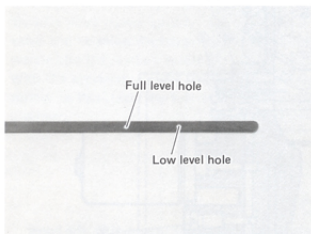
**Engine oil servicing**

For the engine oil, use a 4-stroke engine oil (Refer to page 1-14). Each oil change requires this much oil.

Periodical oil change	2,500 cc (5.28/4.40 US/Imp pt)
Filling up after engine overhauling	3,000 cc (6.34/5.28 US/Imp pt)

**Oil level:**

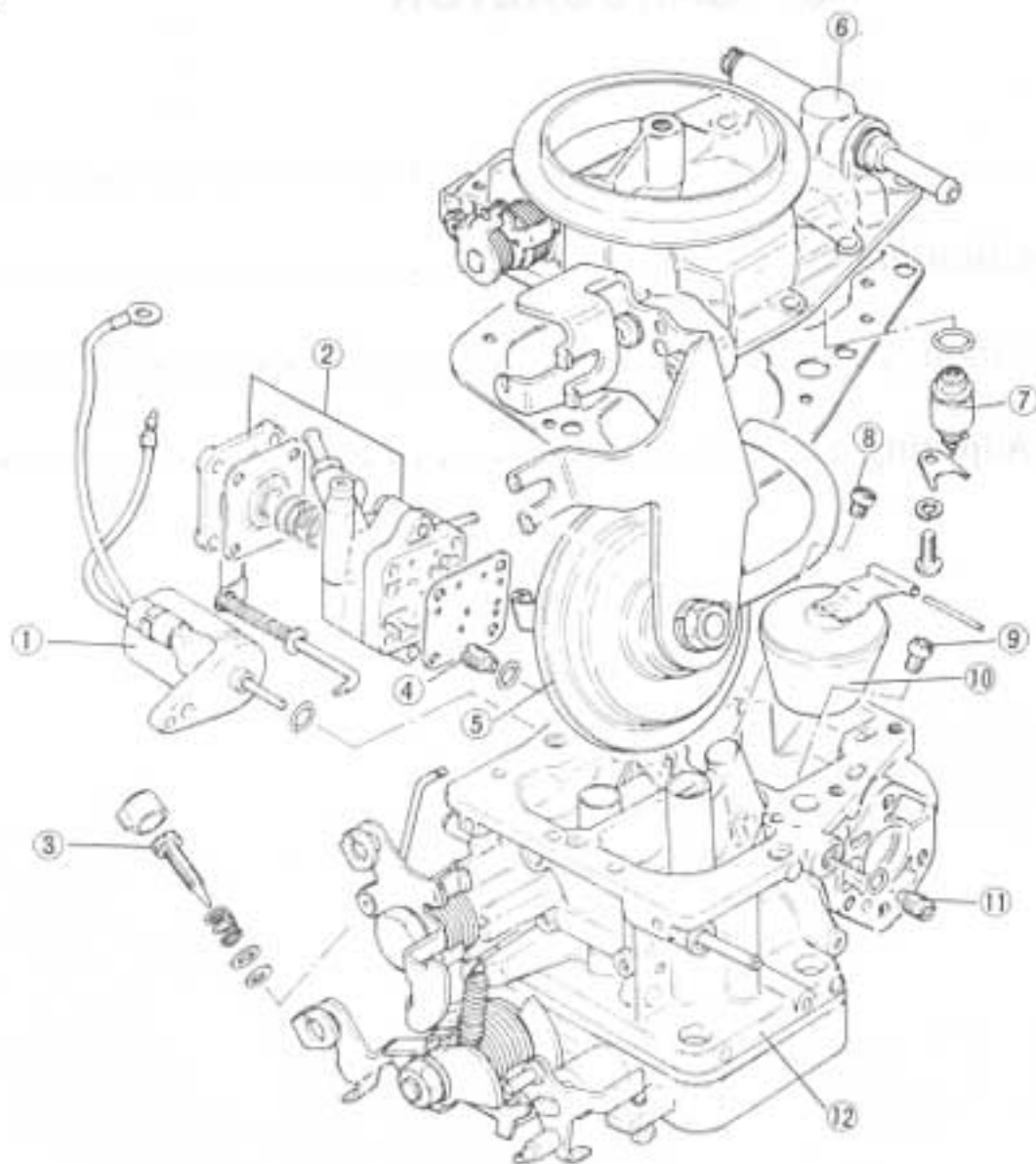
Refill the engine oil whenever necessary, in order to maintain the oil surface between "LOW" and "FULL" level holes on the oil level gauge.



*Fig. 4-174 Oil level gauge*

## 5-1. Description

This carburetor is of Solex type provided with two venturis, primary and secondary, and among its component parts as shown below are an acceleration pump which operates when accelerating, a fuel cut solenoid valve which helps prevent engine run-on and a depression chamber which actuates the secondary throttle valve.



- |                     |                       |                             |
|---------------------|-----------------------|-----------------------------|
| ① Solenoid          | ② Accelerating pump   | ③ Pilot screw               |
| ④ Primary pilot jet | ⑤ Depression chamber  | ⑥ Float chamber upper cover |
| ⑦ Needle valve      | ⑧ Primary main jet    | ⑨ Secondary main jet        |
| ⑩ Float             | ⑪ Secondary pilot jet | ⑫ Carburetor body           |

Fig.5-1

## 5-2. Carburetor Specifications

Item	Primary	Secondary
Throttle bore diameter	24 mm (0.94 in)	30 mm (1.18 in)
Venturi diameter	18 mm (0.71 in)	22 mm (0.87 in)
Main jet	# 88.8	# 132.5
Main air hole	No. 1 0.5, No. 2 0.4	1.2
Pilot jet	# 40	# 65
Pilot air hole	No. 2 1.8, No. 1 1.5	1.6



### 5-3. Carburetor Operation

#### Float chamber

The float chamber with its needle valve is a vessel receiving the fuel from the fuel pump and holding it up to a certain constant level. The float responds to the up-and-down movement of fuel surface and actuates the needle valve.

#### Slow speed circuit

When the engine starts to run, the fuel in the float chamber flows out through main jet ① and reaches pilot (slow) jet ②. There, incoming fuel is metered and mixed with the air metered at pilot (slow) air holes No. 2 ⑱ and No. 1 ⑳. This air-fuel mixture is sprayed out from bypass port ③ and idle port ④. During idling, the mixture is sprayed out mainly from idle port ④ and mixed with the air flowing into the main bore. Thus, the air-fuel mixture can be made leaner or richer by tightening or loosening the idle mixture adjusting screw respectively.

#### NOTE:

Bypass screw ⑤ adjustment in your market is prohibited. The bypass screw ⑤ is used only within the assembly process of a new car in our factory to control idle mixture.

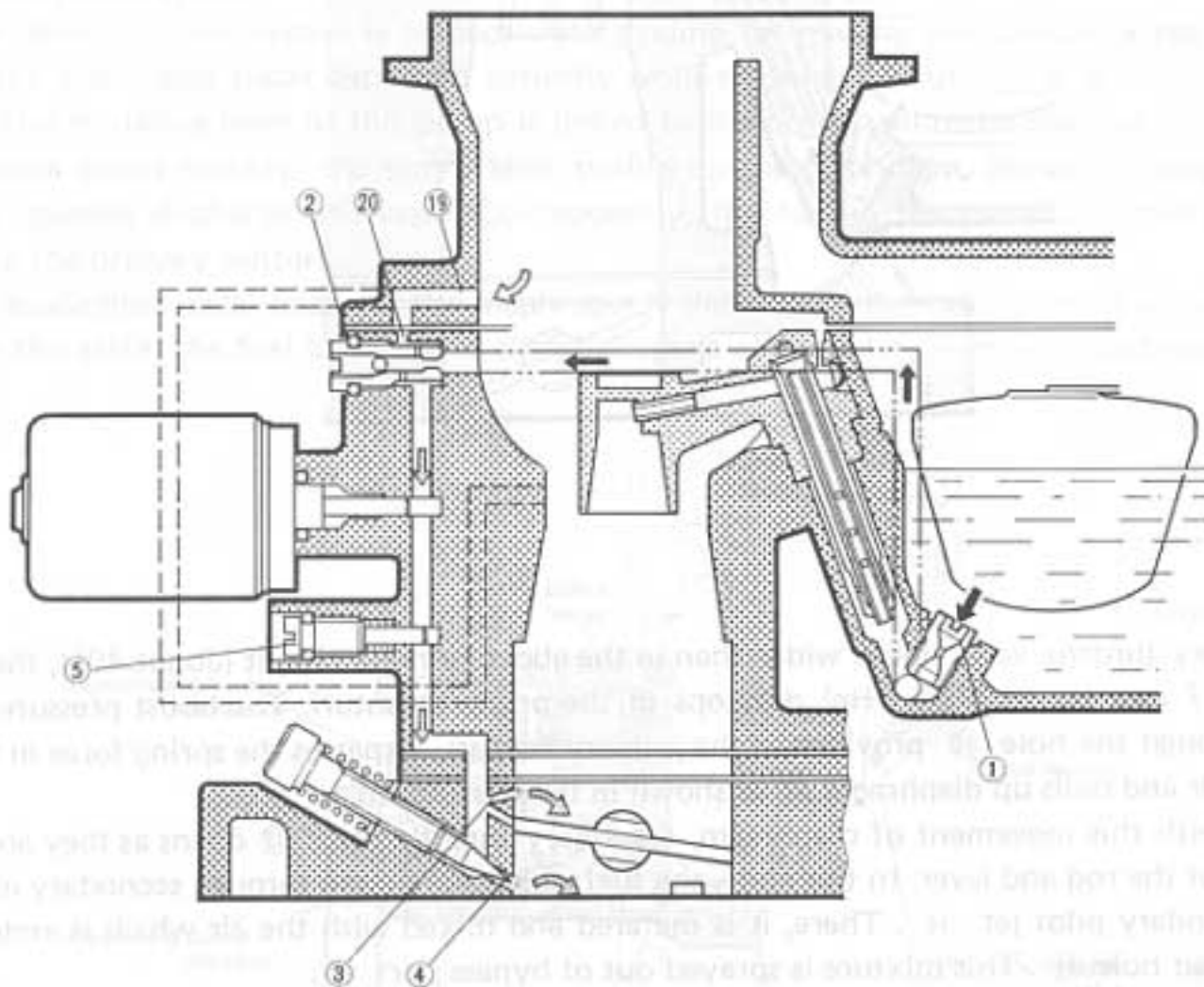


Fig. 5-2

### High speed circuit

#### [Primary circuit]

When the accelerator pedal is depressed from the idle speed position (wider opening of the primary throttle valve), the fuel in the float chamber is metered at primary main jet ① and flows into primary bleed pipe ⑧. There, it is mixed with the air metered at primary main air holes No. 1 ⑥ and No. 2 ⑦. This air-fuel mixture is sprayed out into the inner venturi ⑨ through the primary main nozzle.

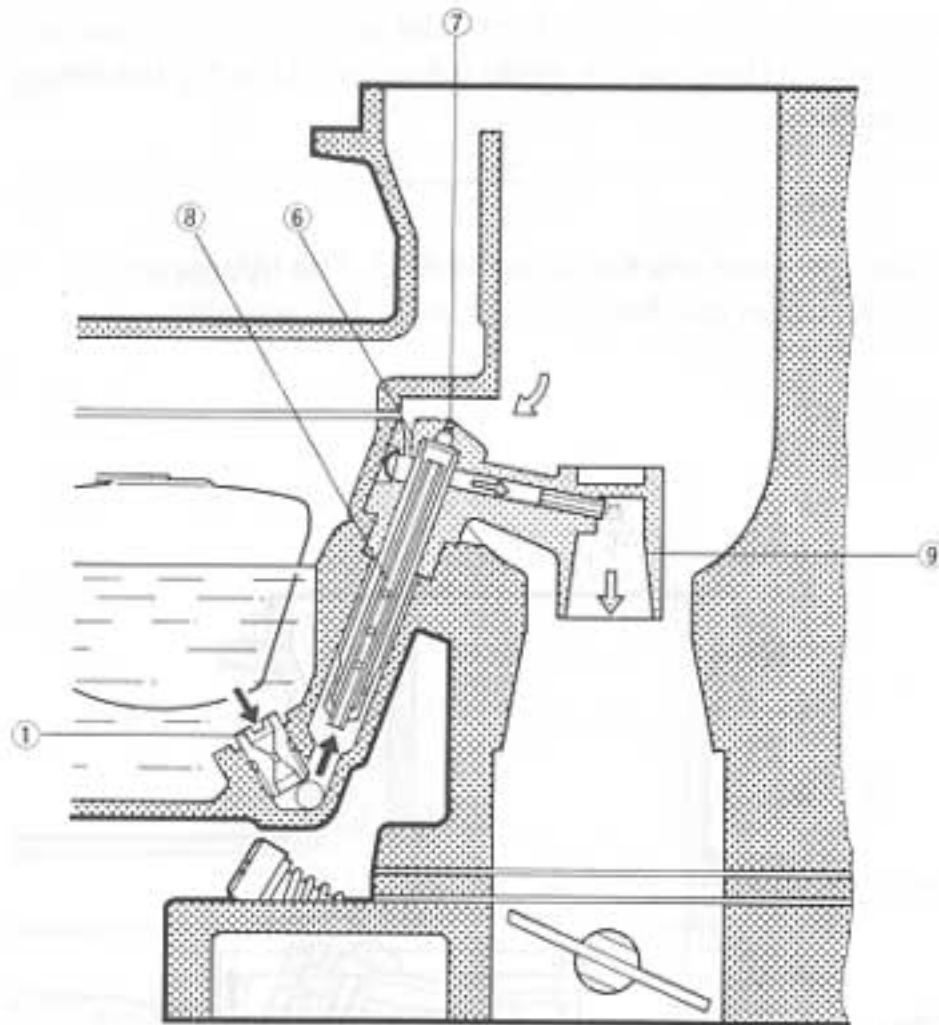


Fig. 5-3

#### [Secondary circuit]

When the primary throttle valve opens wider than in the above primary circuit (about  $40^\circ$ ), the boost pressure about 7 mm Hg (0.275 in Hg) develops in the primary venturi. The boost pressure, being transmitted through the hole ⑩ provided in the primary venturi, surpasses the spring force in the depression chamber and pulls up diaphragm ⑪ as shown in the illustration.

In accordance with this movement of diaphragm, secondary throttle valve ⑫ opens as they are interlocked by way of the rod and lever. In this state, the fuel which has passed through secondary main jet ⑬ reaches secondary pilot jet ⑭. There, it is metered and mixed with the air which is metered at secondary pilot air hole ⑮. This mixture is sprayed out of bypass port ⑯.

When the boost pressure in the primary venturi gets higher and boost pressure develops in the secondary venturi, too, the secondary throttle valve opens wider (more than about  $5^\circ$ ). In this state, the fuel metered at main jet ⑬ and the air metered at secondary main air hole ⑰ are mixed in bleed pipe ⑱. Then this air-fuel mixture is sprayed out into the secondary venturi.

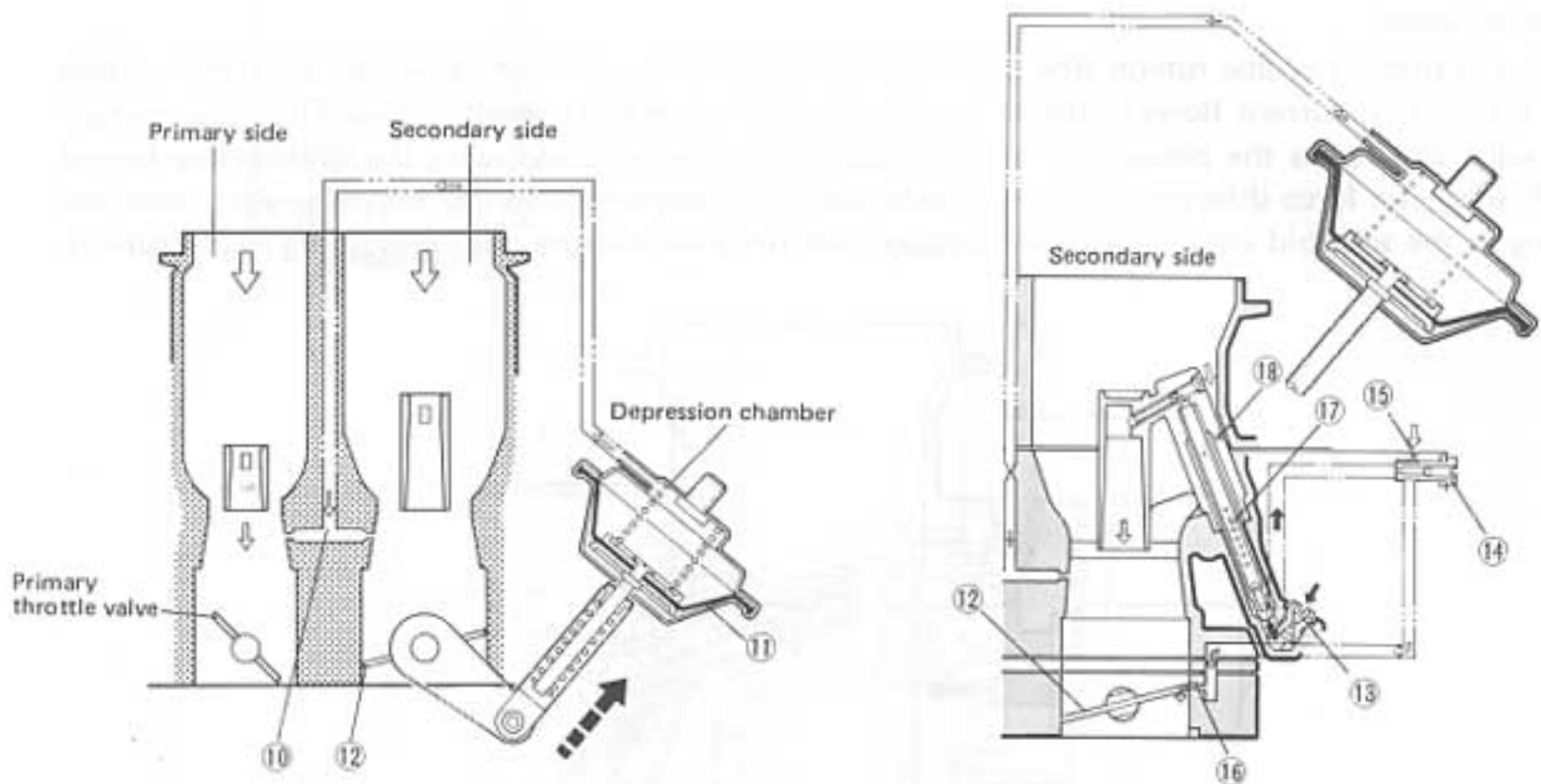


Fig. 5-4

#### Acceleration power system

The main device of this system is an accelerating pump for making the carburetor respond without delay to the accelerator pedal depressed abruptly while the engine is running in its low speed range or is idling. The actuating lever of this pump is linked to the primary throttle shaft so that, as primary throttle valve opens quickly, the pump lever pushes up the diaphragm, thereby closing suction ball valve and opening discharge ball valve. Consequently, the fuel in the pump is forced out of pump nozzle into the primary venturi.

With the accelerator pedal released, the diaphragm is set back to the original position with the pump spring. In this state, the fuel in the float chamber opens up the inlet check valve and enters the pump chamber.

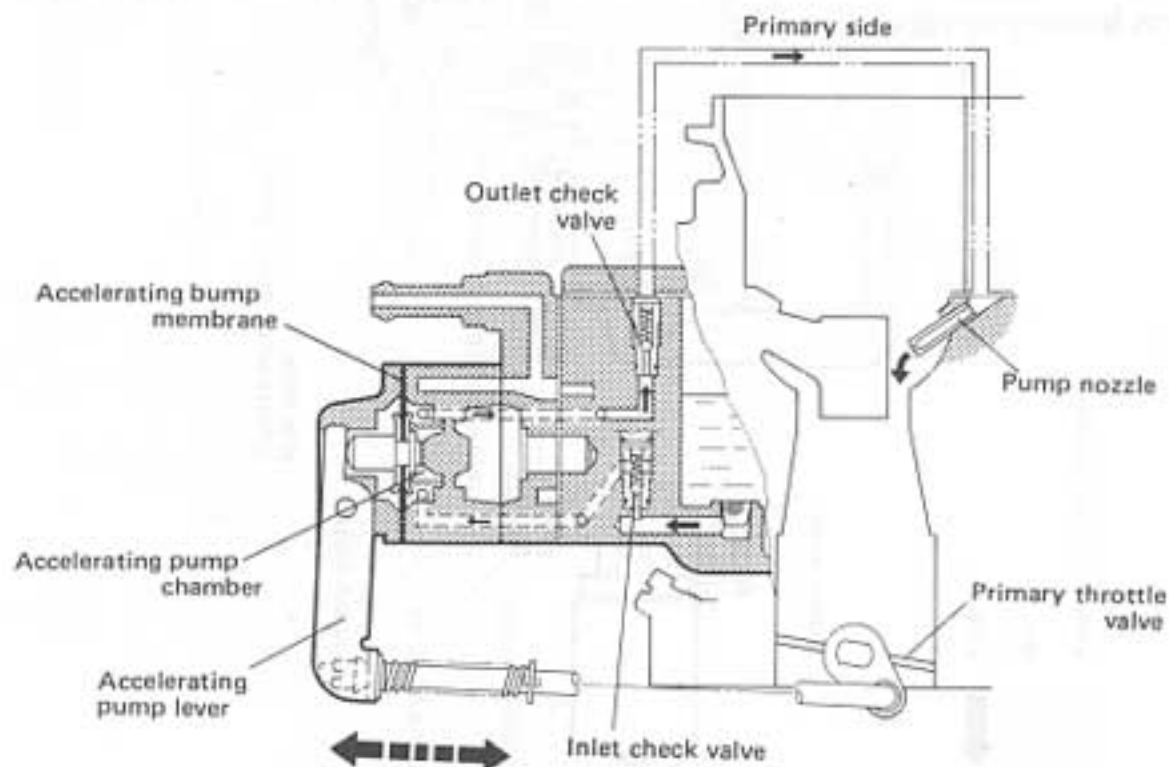


Fig. 5-5



### Solenoid valve

This is to prevent engine run-on (the engine doesn't stop at the ignition key OFF). With the ignition key turned ON, current flows in the solenoid coil which generates magnetic force. This pulls the needle valve and opens the passage for slow mixture. On the other hand, with the ignition key turned OFF, magnetic force disappears and the needle valve is brought back to the original position with the spring in the solenoid valve. The closed passage cuts off slow mixture, thus preventing engine run-on.

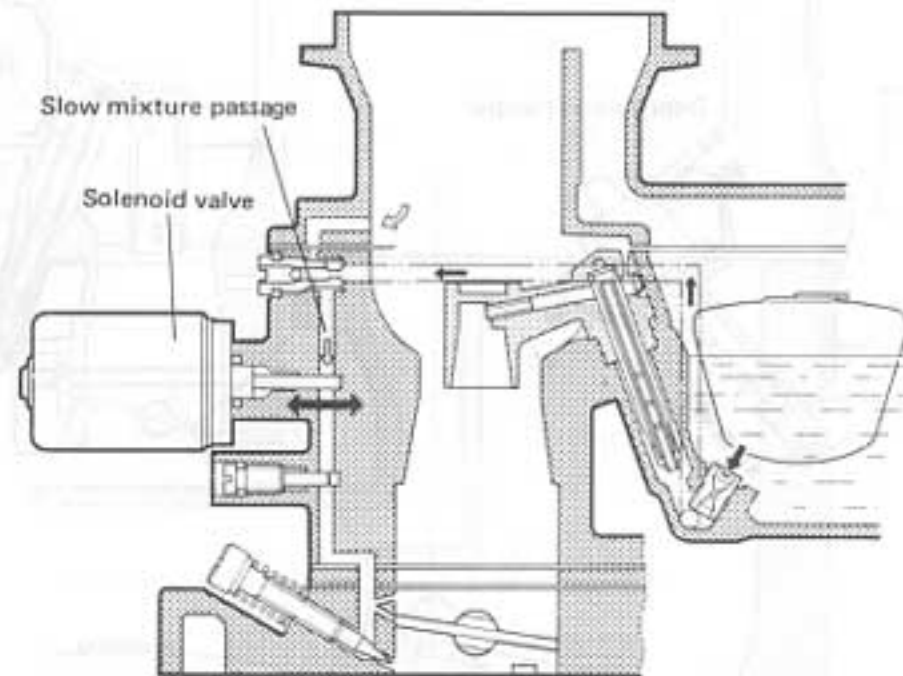


Fig. 5-6

### Fuel return system

A fuel return circuit is provided in this carburetor in order to avoid "vapor locking" of fuel. How "vapor locking" is avoided will be explained: When the fuel level rises in the float chamber, its float valve closes; and, as the level falls, the valve opens. With the valve closed, the incoming fuel (delivered under pressure by the pump) finds its way through the sidewise hole provided in the top part of the float valve anchoring point and flows through the passage drilled out through the float chamber wall and around the acceleration pump chamber and back to the fuel tank filler. This arrangement allows the fuel pump to keep on delivering fuel. For this reason, the incoming fuel for the float chamber is always "cold" and cools the acceleration-pump chamber by flowing past its chamber, thereby suppressing the conditions leading to vapor locking.

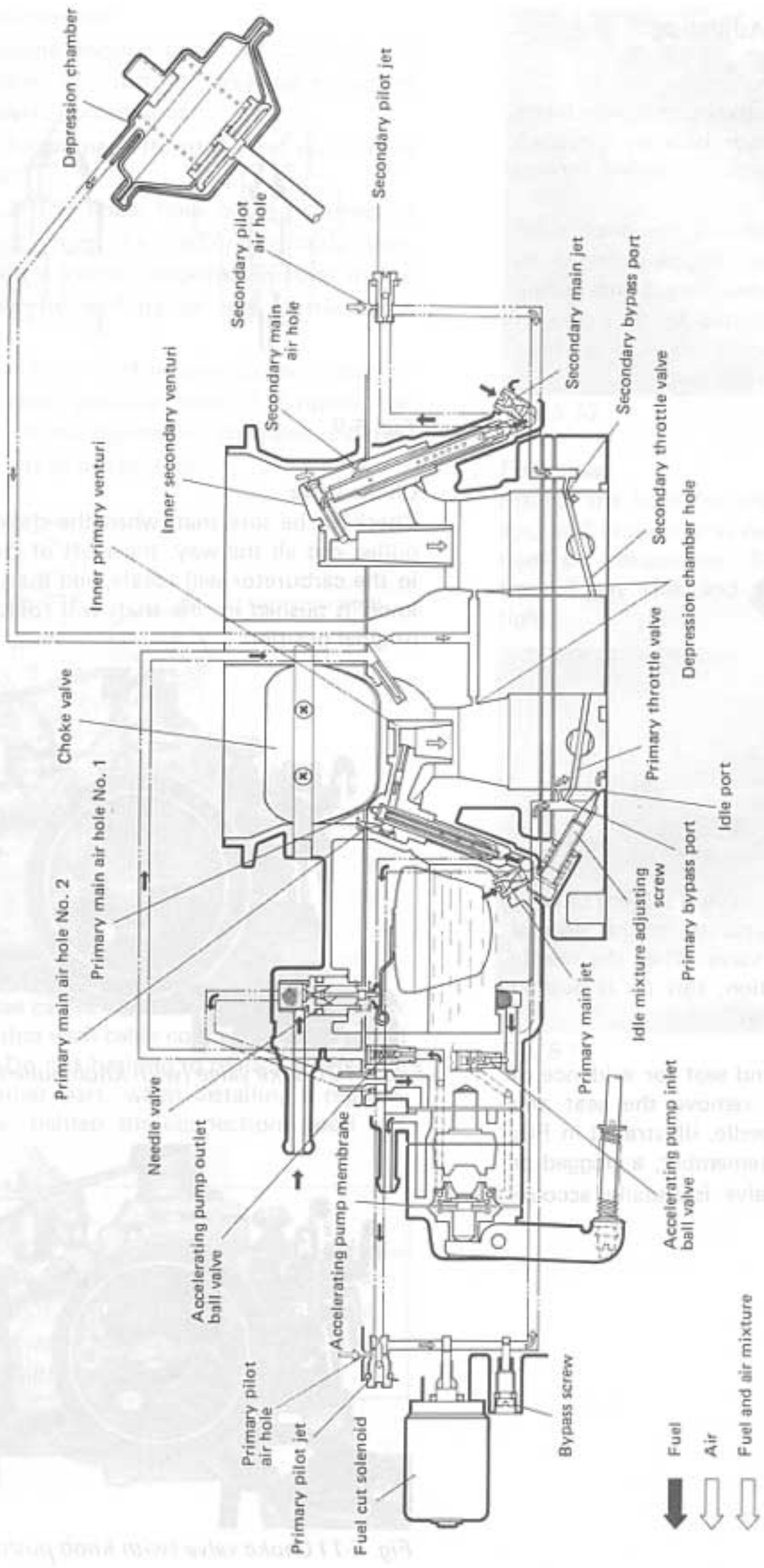


Fig. 5-7 Carburetor circuit diagram

## 5-4. Inspecting and Adjusting

### Jets

Wash the jets clean. Wash the holes in which jets are located, and clear each hole by directing compressed air to it, thereby removing foreign matter, if any.

A clogged pilot jet is usually responsible for erratic engine idling. Erratic engine operation in the medium and high-speed ranges and during acceleration is often accounted for by a clogged condition of main jet, main air hole or hole constrictions in the carburetor body.



Fig. 5-8

### Needle valve

The conical tip of needle valve is subject to wear as this tip seats and unseats in the normal operation of the needle valve. When the needle valve is in closed condition, this tip is pushed against the seat by the float.

Inspect the conical tip and seat for evidence of clogging. As necessary, remove the seat and wash it clean. A worn needle, illustrated in Fig. 5-9, must be replaced. Remember, a clogged or poorly seating needle valve is usually accountable for "overflow."

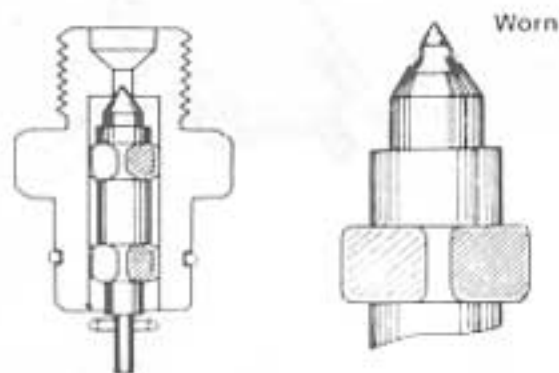


Fig. 5-9

### Choke valve

Check to be sure that, when the choke knob is pulled out all the way, the shaft of choke valve in the carburetor will rotate, and that, when the knob is pushed in, the shaft will rotate back to original position.

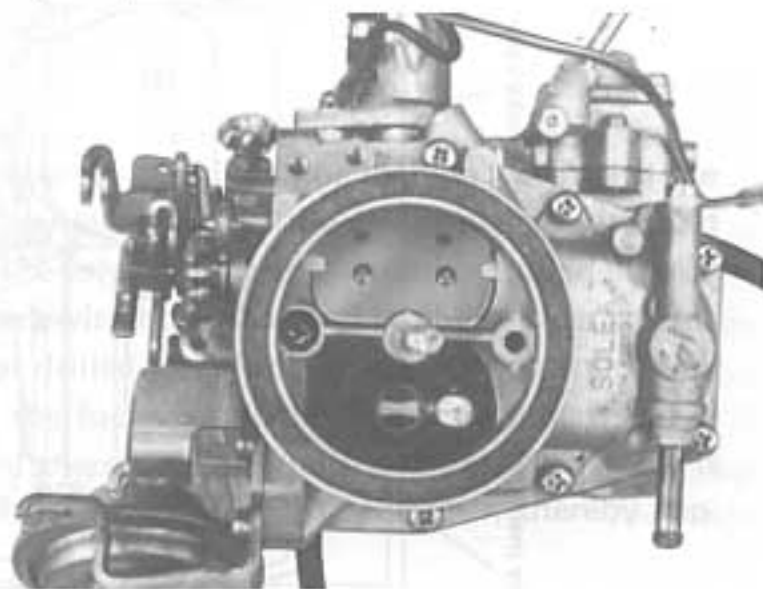


Fig. 5-10 Choke valve (with knob pulled out fully)

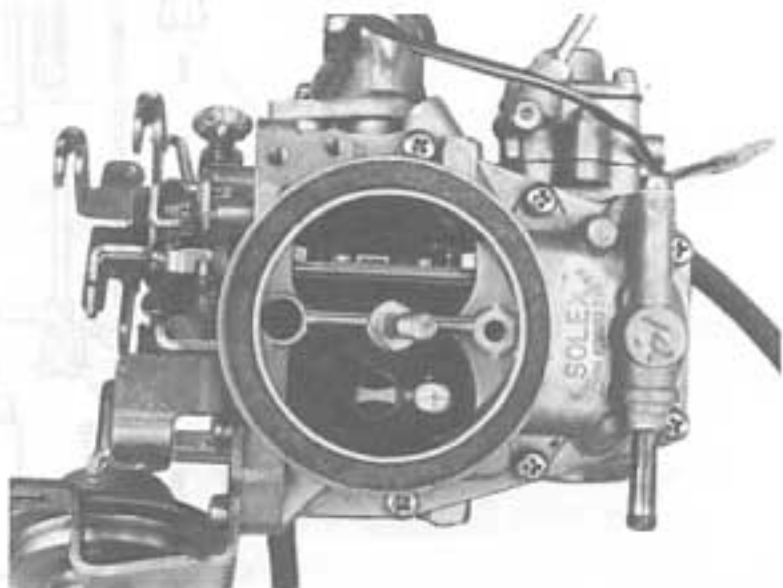


Fig. 5-11 Choke valve (with knob pushed in fully)

### Depression chamber

With the engine stopped, check the diaphragm in the depression chamber for breakage according to the following procedures.

- 1) Keep the primary throttle valve open more than  $40^\circ$ .
- 2) Pull out the boost hose on the depression chamber from the carburetor body side.
- 3) Maintain a certain negative pressure in the chamber by sucking air out of the boost hose.

If the secondary throttle valve doesn't open or comes to close gradually even if it opens, the diaphragm in the depression chamber is defective and needs to be replaced.

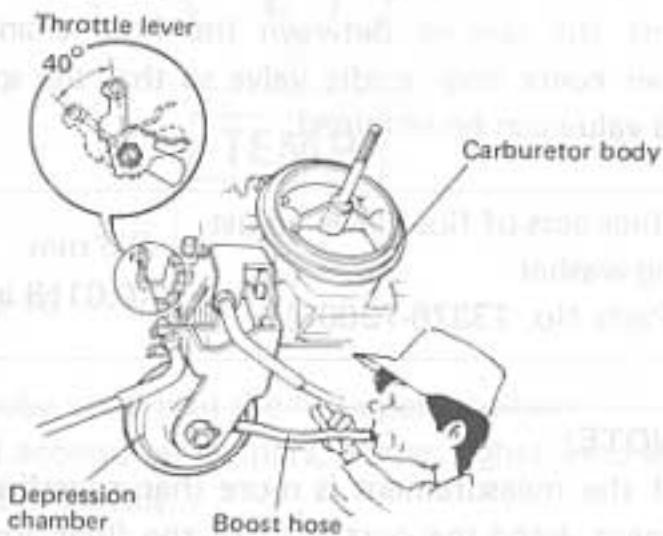


Fig. 5-12

### Accelerator and choke cables

Inspect these cables for wear and tear, and check to be sure that each cable connection is in sound condition. Do not hesitate to replace a defective cable or other part; when installing a replacement cable, tighten the connections good and hard.

#### NOTE:

Install the choke cable to the carburetor body with the choke knob pulled out about 7 mm (0.27 in.). If this is not done, the choke valve may not return completely to the original position.



Fig. 5-13

### Fuel hose

Inspect the hose for cracks and signs of breakage, and replace it as necessary. Examine it for signs of leakage, too. Be sure that the hose is free of any leak and that its connections are tight.

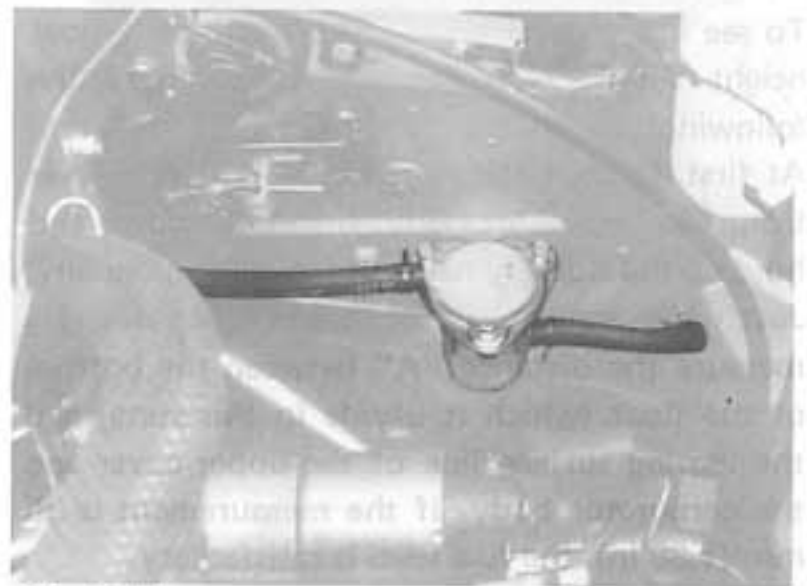


Fig. 5-14



### Fuel tank cap

This cap is fitted with a rubber packing. Be sure that the packing is in good condition and that the cap in place is tight and leak-free.



Fig. 5-15

### Fuel level adjustment

To see if fuel level is properly maintained, float height should be measured according to the following procedure.

At first, remove the float chamber upper cover from the carburetor body. Invert the cover and hold up the float by hand and lower it gradually. Just when tongue ① touches needle valve ②, measure the distance "A" between the bottom of the float (which is upside in this state) and the mating surface line of the upper cover and the carburetor body. If the measurement is 35 mm (1.38 in), the fuel level is satisfactory.

#### NOTE:

The gasket must be removed when taking measure of "A".

Float height specification "A"	35 mm (1.38 in)
--------------------------------	-----------------

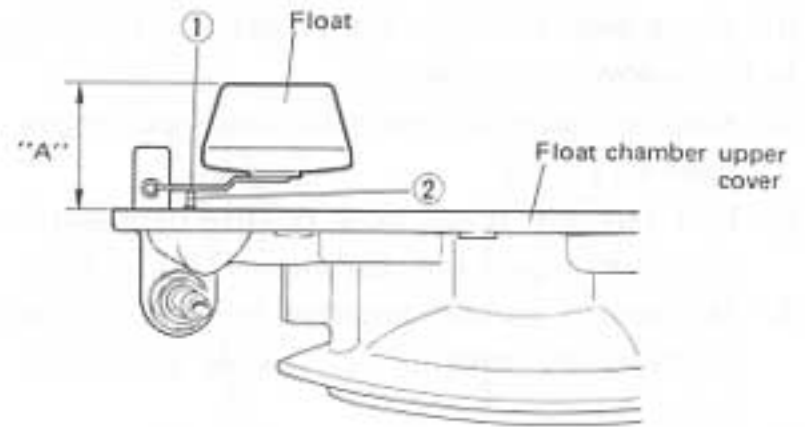


Fig. 5-16

If the measurement is less than specified value, insert the washer between the float chamber upper cover and needle valve so that the specified value can be obtained.

Thickness of float level adjusting washer (Parts No. 13378-73000)	0.3 mm (0.0118 in)
--	-----------------------

#### NOTE:

If the measurement is more than specified value, bend the part ③ of the float arm indicated in Fig. 5-17 so that the specified value can be obtained.

Never bent the part ④ of the float arm touching needle valve.

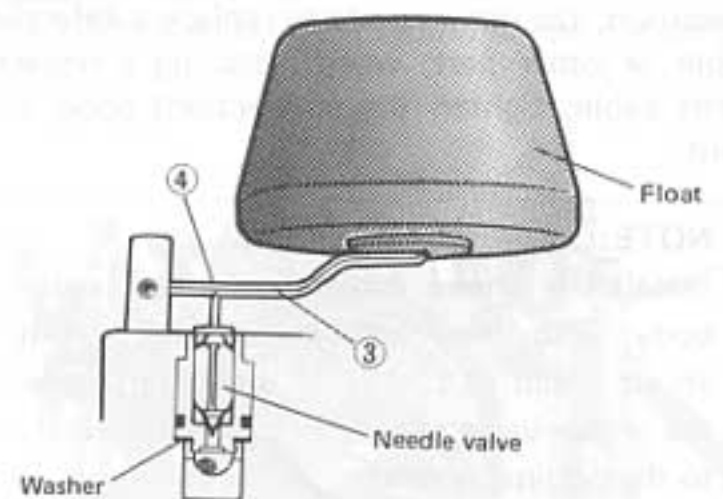


Fig. 5-17

## Idle speed and idle mixture adjustment

### NOTE:

Requires external tachometer.

As preliminary steps, check to be sure that:

- Coolant temperature is approximately 82° C (180° F).

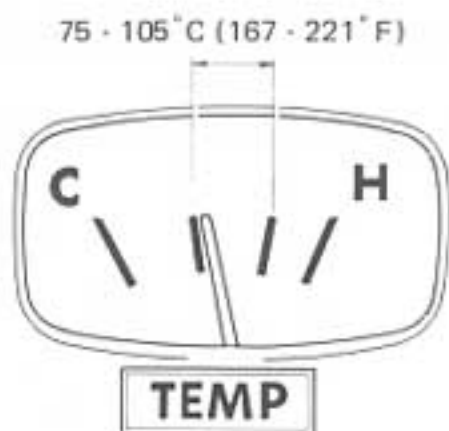


Fig. 5-18

- Choke valve is in the full-open position.
- All accessories (wipers, heater, lights, etc.) are out of service.
- The ignition timing is within specification.
- Fuel level in the carburetor should be specification.
- The air cleaner has been properly installed and is in good condition.

[Idle speed and idle mixture adjustment]

Adjust idle speed by repositioning the idle speed adjusting screw ①, making sure the engine idles steady at 950 r/min (rpm).

Idle mixture adjusting screw ② generally needs no adjustment. However, when the adjusting screw is removed to overhaul the carburetor, adjustment is necessary as follows:

Tighten idle mixture adjusting screw ② fully and; gradually untightening it, set the screw at a position where the engine speed is the highest (best idle). Then, readjust the engine idling speed to 950 r/min (rpm) with idle speed adjusting screw ①.

### CAUTION:

- When cars are used in countries where exhaust gas regulations are in force, check the exhaust gas with an exhaust gas tester. If gas exceeds the value specified in the regulations, adjust the idle mixture adjusting screw ②.

Engine idling speed specification	950 ± 50 r/min (rpm)
-----------------------------------	----------------------

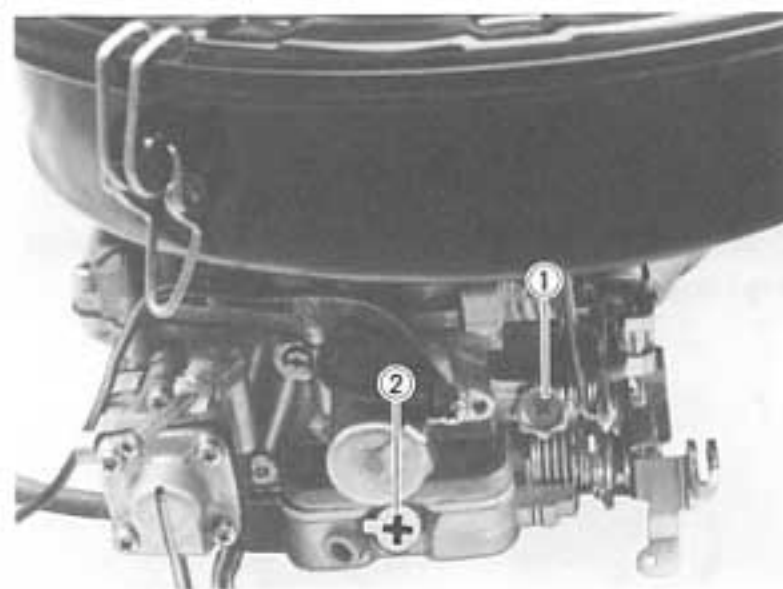


Fig. 5-19

## 6-1. Air Cleaner

### Servicing

This air cleaner element is of dry type. Remember that it needs cleaning according to the following method and interval.

- 1) Take out the cleaner element ① off the air cleaner case.

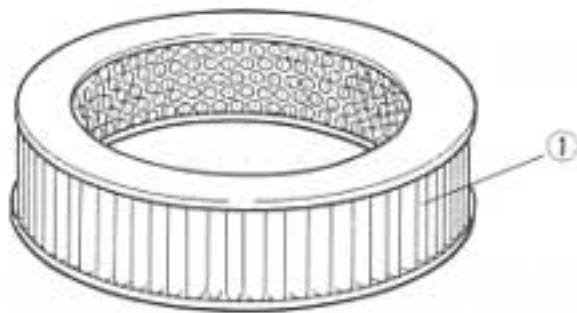


Fig. 6-1

- 2) Blow off dust by compressed air from inside of element.



Fig. 6-2

### NOTE:

If the element are heavily dirtied, wash it in household type detergent. After washing, rinse the detergent out of element, and dry it completely.

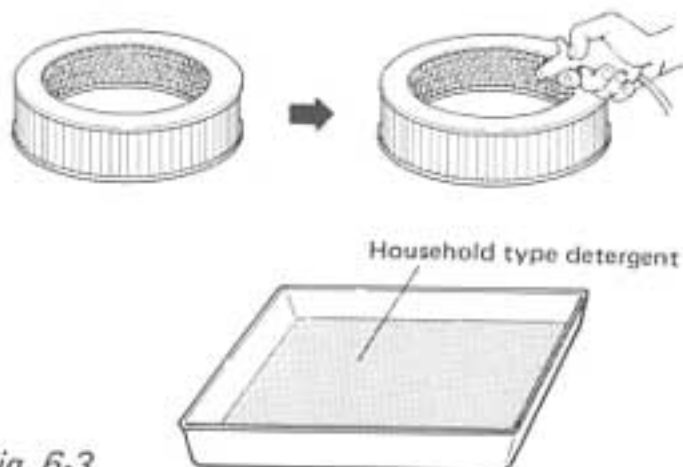


Fig. 6-3

Clean	Paved-road: Every 10,000 km (6,000 miles)
	Dusty condition: Every 2,500 km (1,500 miles) or as required
Replace	Every 40,000 km (24,000 miles)

### NOTE:

More frequent replace if under dusty driving conditions.

### Air cleaner case

When installing the air cleaner case cap, align the arrow marks ① and ②.

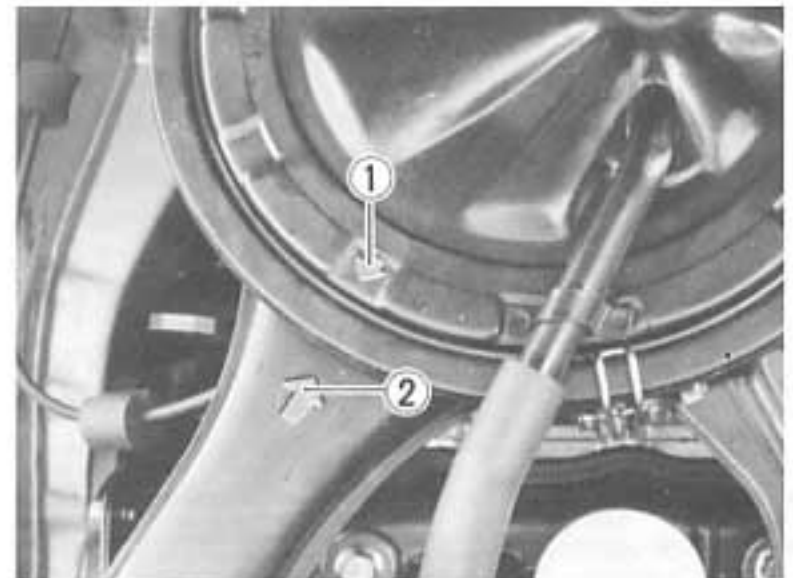


Fig. 6-4

### Use of the selector lever

A mispositioned selector lever can cause the carburetor to get "iced" in freezing weather or the engine to overheat in hot weather. Position this lever according to the atmospheric temperature, i.e., in WINTER position when outside temperature is 15°C (59°F) or below, or in SUMMER position when the temperature is above that level.

Warm-air selector lever position	
Atmospheric temperature	Lever position
15°C (59°F) or below	WINTER
Above 15°C (59°F)	SUMMER

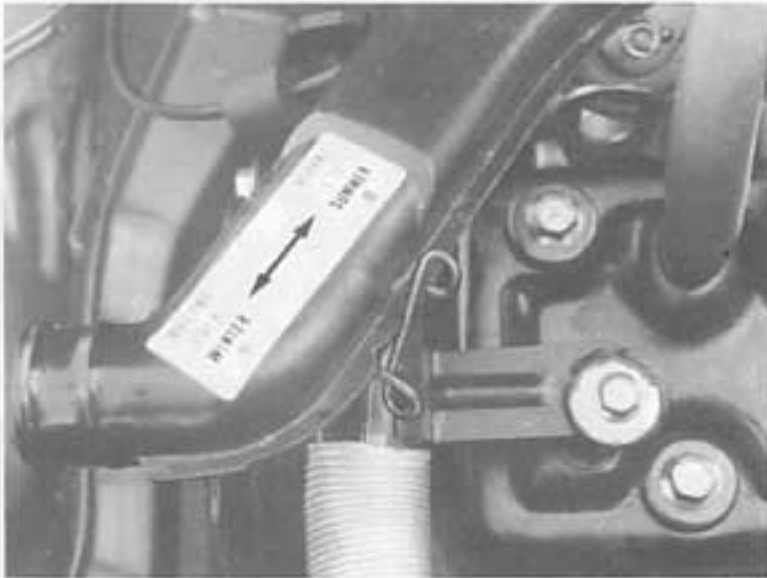


Fig. 6-5



## 6-2. Fuel Pump

### Description

A pneumatic diaphragm pump is used to deliver gasoline to the float chamber in the carburetor. Its diaphragm is actuated from one of the cams formed of engine camshaft. A rocker arm rides on this cam and moves the pump diaphragm up and down.

As this fuel pump is of non-disassembly type, replace it as an assembly unit if it is not in good condition.

Fuel pump specifications	
Discharge pressure	0.20 - 0.30 kg/cm <sup>2</sup> (2.85 - 4.27 psi)
Pump capacity	0.2 litres/minute or better at 2,000 r/min

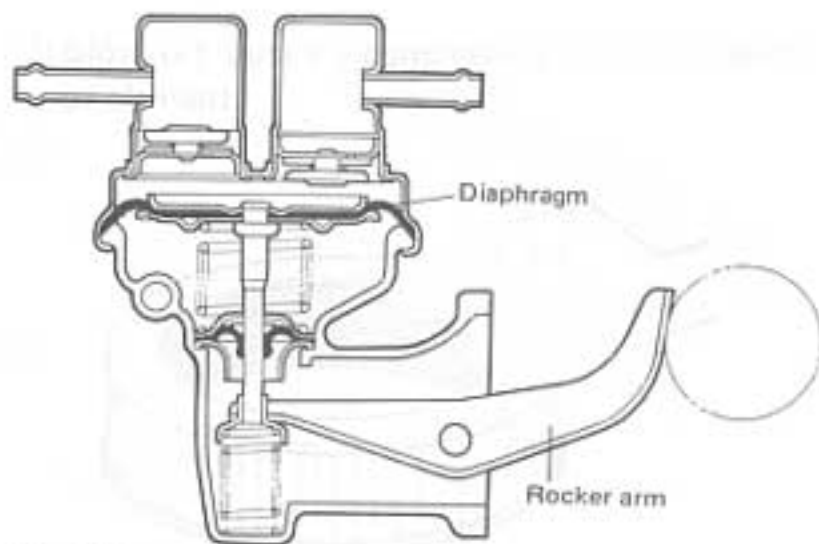


Fig. 6-6



Fig. 6-7

### Removal

- 1) Disconnect the inlet and outlet hoses from the fuel pump body.
- 2) Remove the fuel pump by loosening the two bolts.

### CAUTION:

Engine oil will come out of the distributor drive gear case when the fuel pump is removed from the case. Never allow this oil to find its way into the transmission case.



Fig. 6-8

### Inspection

- Check the fuel pump diaphragm for breakage. The diaphragm is in good condition if there is no evidence of gasoline leakage where the fuel pump is installed. (See Fig. 6-9)



Fig. 6-9

- Check where the rocker arm of the fuel pump and the cam of the camshaft contact for uneven wear.

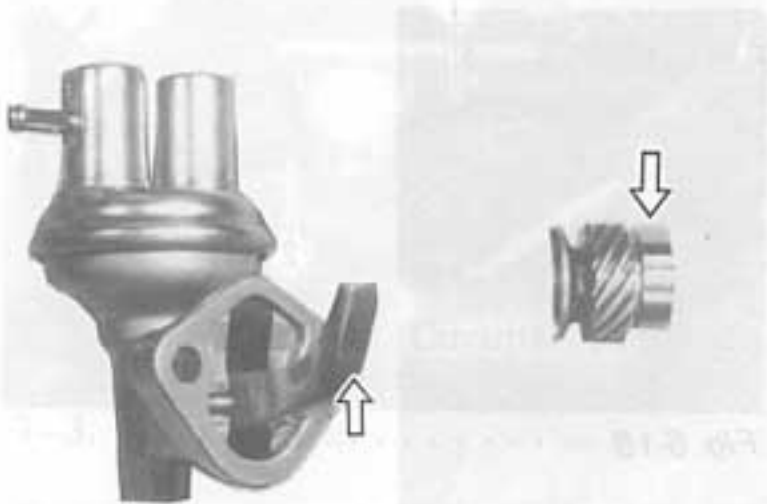


Fig. 6-10

#### Important step in installation

When piping the fuel pipe after installation of the fuel pump, connect the hose coming from the fuel filter with the pipe on the "IN" marked side of the surge tank.

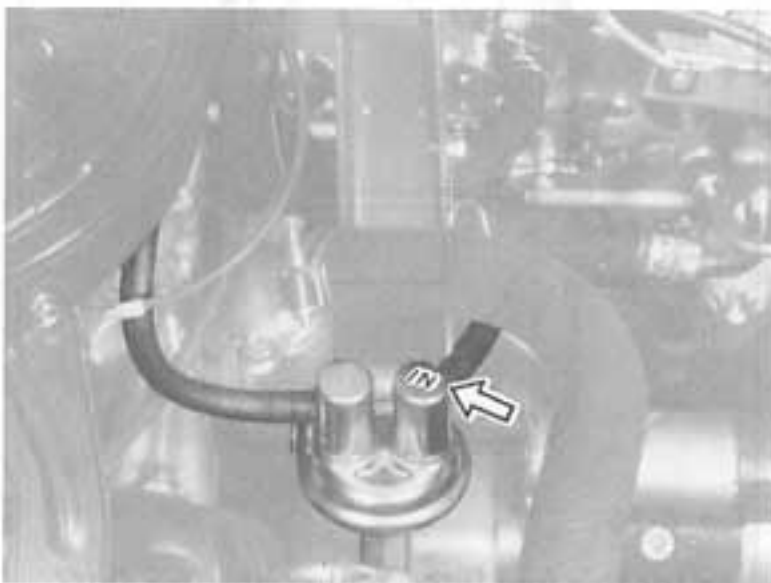


Fig. 6-11

## 6-3. Fuel Filter

### Description

Fuel enters the filter through its inlet hole and, after passing through the filtering element, comes out of its outlet hole communicated to the fuel pump. This filter can be disassembled.

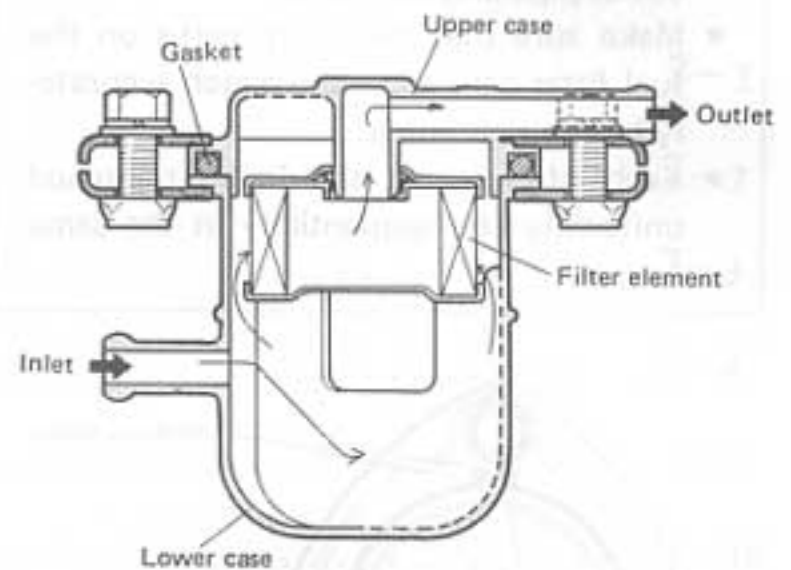


Fig. 6-12

### Servicing and installation

Clean or replace this fuel filter element periodically according to the following.

Clean	Every 10,000 km (6,000 miles)
Replacement	Every 40,000 km (24,000 miles)

#### [Fuel filter element cleaning and replacing]

- Separate fuel filter to upper case and lower case and air-blow to clean upper case from its outlet pipe side, and also clean the lower case inside.

#### NOTE:

Do not separate filter element and filter upper case at this point.

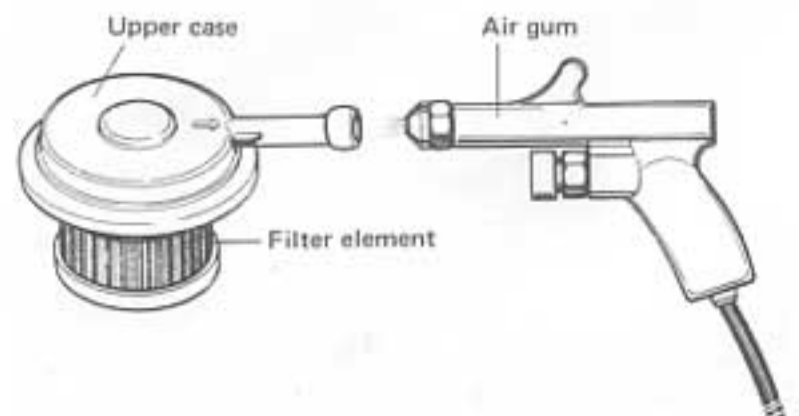


Fig. 6-13

**NOTE:**

- Whenever replacing the fuel filter element, replace the gasket, and then clean the lower case inside.
- When putting together upper case and lower case, pay attention to direction of outlet pipe and inlet pipe.
- Make sure that matching marks on the fuel filter case and plate match accurately before tightening.
- Each of 3 screws should be tightened uniformly and sequentially at the same torque.

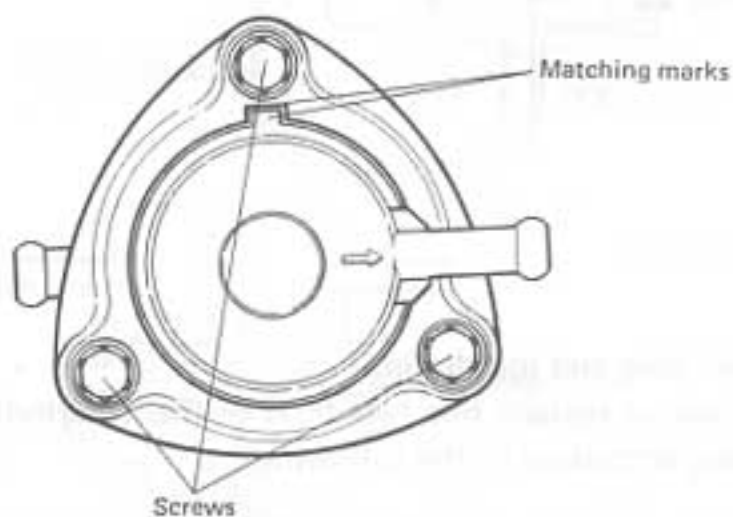


Fig. 6-14

**WARNING:**

After installing fuel filter, check to ensure that there is no leakage of gasoline.

Fig. 6-15, shows the fuel filter in its correct posture, with outlet ① coming on top side and inlet ② on bottom side. Remember the relative positions of inlet and outlet when piping the filter.

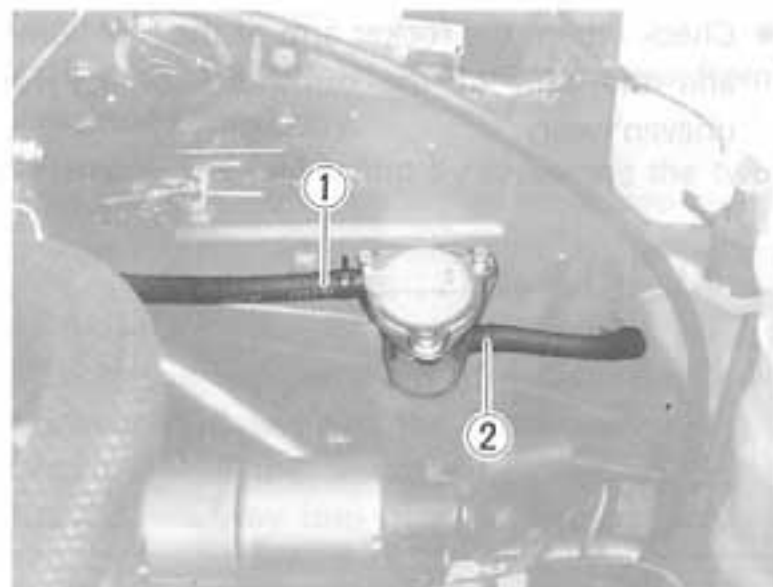


Fig. 6-15

**NOTE:**

The fuel filter as shown below has been fitted from '81 late June production. This filter can not be disassembled. It is of cartridge type, consisting of a filtering element in a plastic case.

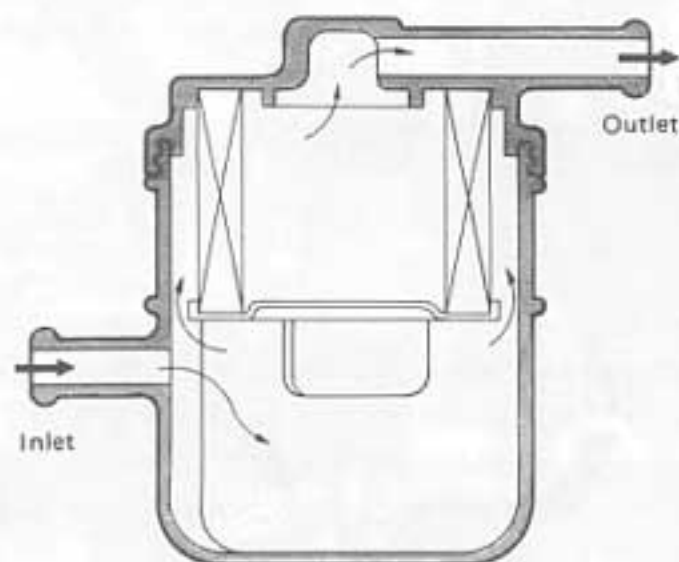


Fig. 6-16

As for this fuel filter, replace the fuel filter ass'y periodically according to the following.

Replacement	Every 40,000 km (24,000 miles)
-------------	-----------------------------------

## 7-1. Description

The engine is cooled by coolant set in forced recirculation through jackets formed in the engine body and through the radiator. For the water pump, a high-capacity centrifugal pump is used. For the radiator, a tube-and-fin type, large in heat dissipating capacity, is used.

The thermostat is of wax pellet type, accurately responsive to temperature changes and durable in construction. It maintains the coolant temperature within a narrow range during operation.

## 7-2. Cooling Water Circuit

The thermostat remains in closed condition - its valve is closed - when the coolant is cold. Under this condition, the coolant being pumped flows through the circuit comprising cylinder block, cylinder head, inlet manifold, bypass hose and water pump, in that order.

As the temperature rises to 82° C (179° F) or thereabout, the thermostat begins to open, thereby allowing some of the coolant in recirculation to flow through the radiator. At about 95° C (203° F) of rising coolant temperature, the thermostat becomes completely open so that little or no flow occurs through the bypass hose: the coolant now flows through the radiator and back to the pump, releasing the most of heat to the atmosphere through the radiator core.

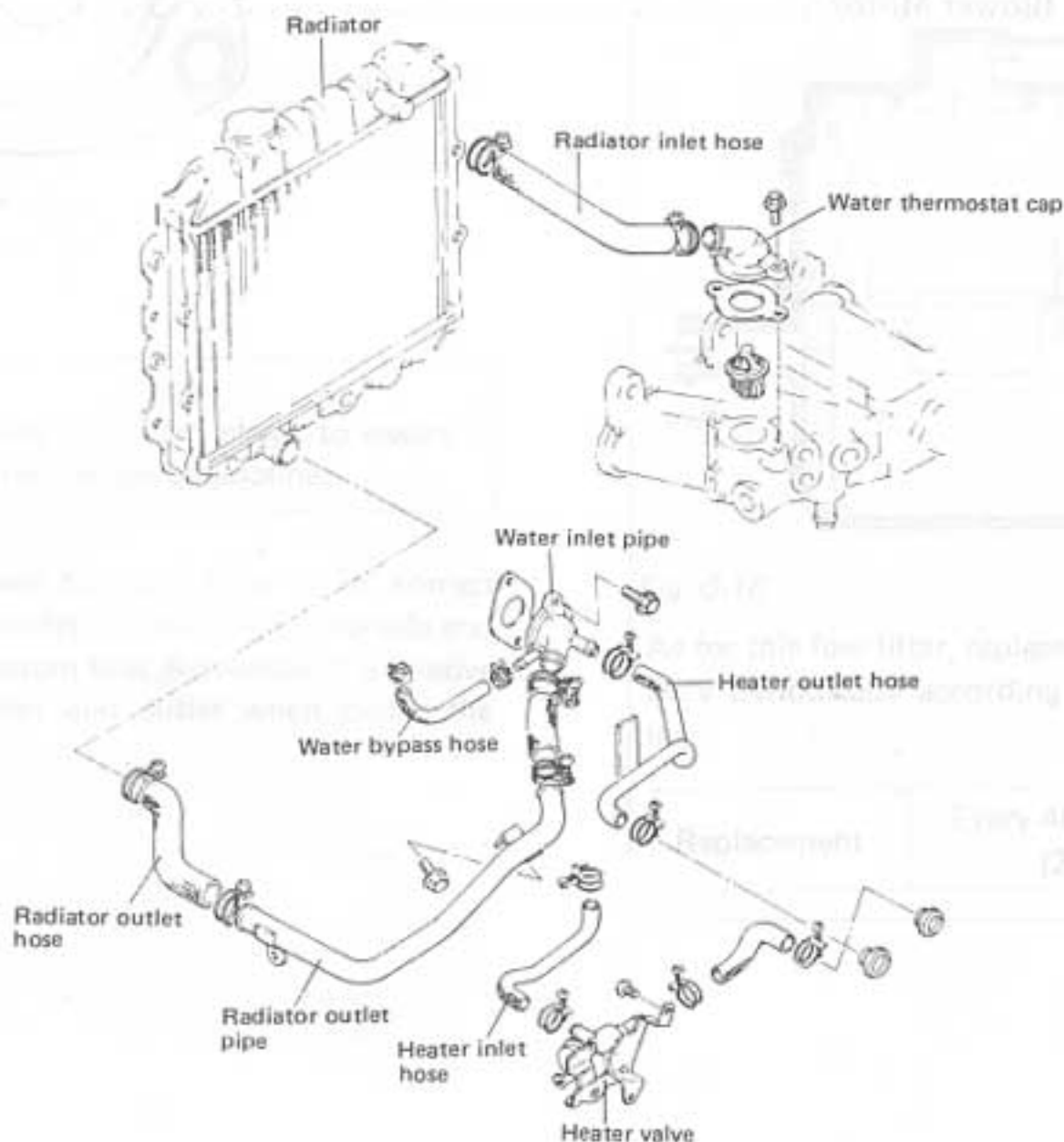


Fig. 7-1



### 7-3. Removal

#### Coolant draining

Loosen the drain plug ① on the radiator to empty its water side.

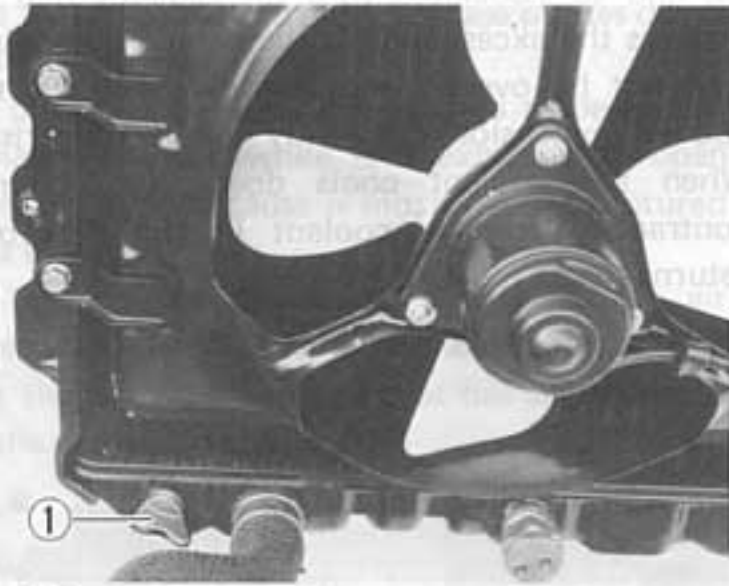


Fig. 7-2

The drain plug ② for engine water jackets is located below the exhaust manifold. To change the coolant, or to drain the jackets for one reason or another, loosen this plug, too.

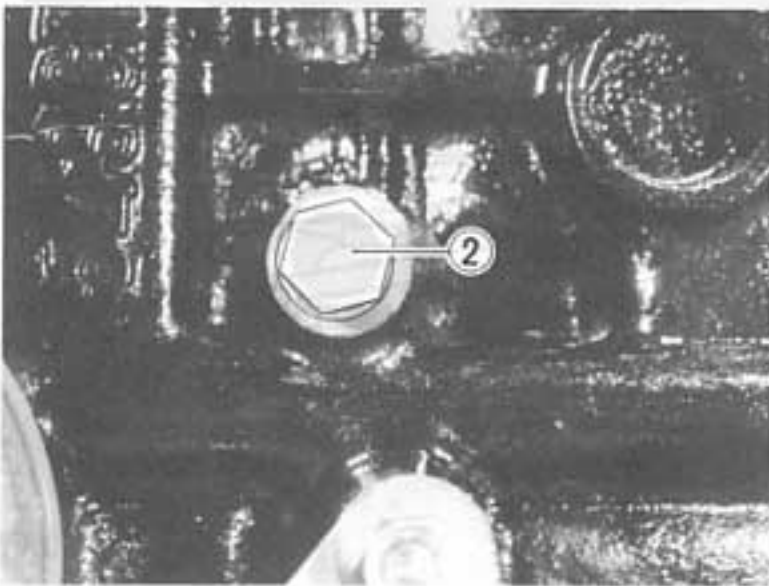


Fig. 7-3

The cap for the radiator is placed on by hand after, giving the internal pressure of coolant circuit to rise to a certain level slightly above that of the atmosphere.

Of the two hand valves, one is an adjusting valve and the other is a pressure-releasing valve. The former opens only when the internal pressure rises to 0.3 kg/cm<sup>2</sup>. This means that the coolant's boiling temperature is 100°C (212°F). If the coolant is brought

#### Radiator removal

1) Remove the front grille.

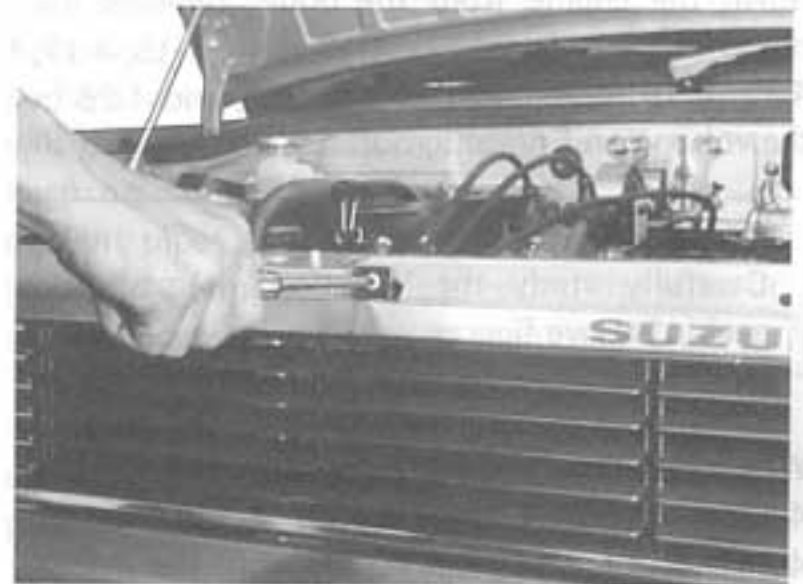


Fig. 7-4

2) Disconnect each water hose at the joint.

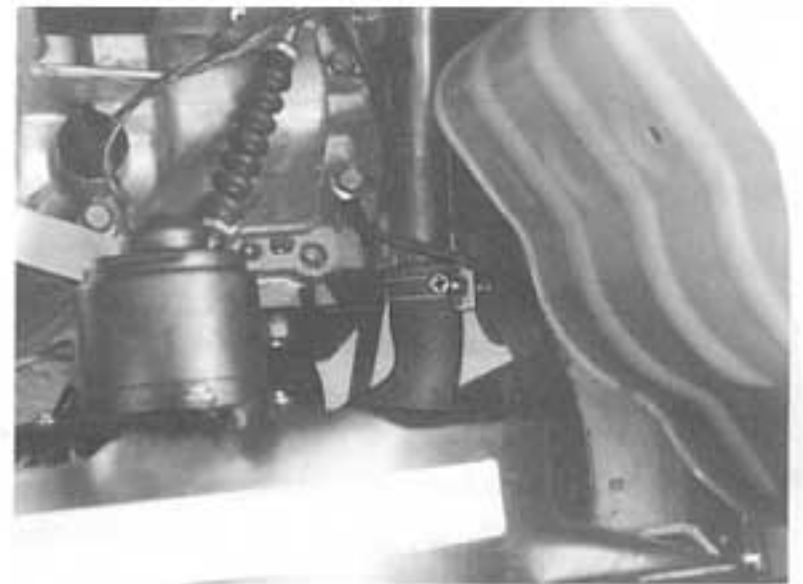


Fig. 7-5

3) Disconnect the lead wires at the coupler and the thermo switch.

4) Remove the radiator.

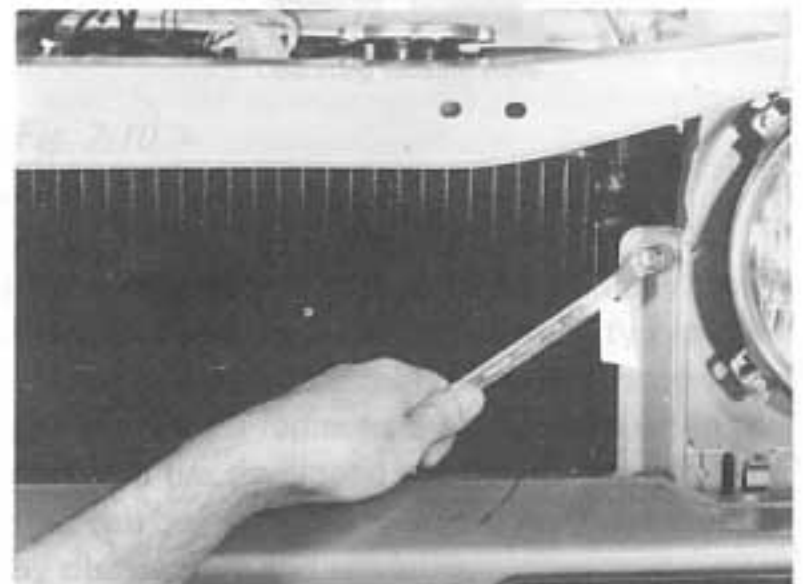


Fig. 7-6

### Water pump removal

The water pump can be removed without taking down the engine from the body. Remove the pump in the order of Fig. 4-12, 4-14, 4-15, 4-17, 4-18, 4-19, 4-20, 4-21, 4-22, 4-23, and 4-25 in the volume on Engine, group 4.

#### **CAUTION:**

Carefully study the "Caution" items for each of above figures.

When installing the water pump, refer to Fig. 4-135, 4-136, 4-137, 4-138, 4-139, 4-140, 4-141, 4-142, 4-143 and 4-147.

## 7-4. Functional Description of Major Components

### Water reservoir tank

This reservoir, a small tank, is so located relative to, and so associated with the radiator that it receives the excess coolant that would otherwise spill out by overflowing. The excess is due to coolant expansion caused by temperature rise. When the coolant cools down, its volume contracts, and the coolant in the reservoir returns to the radiator.

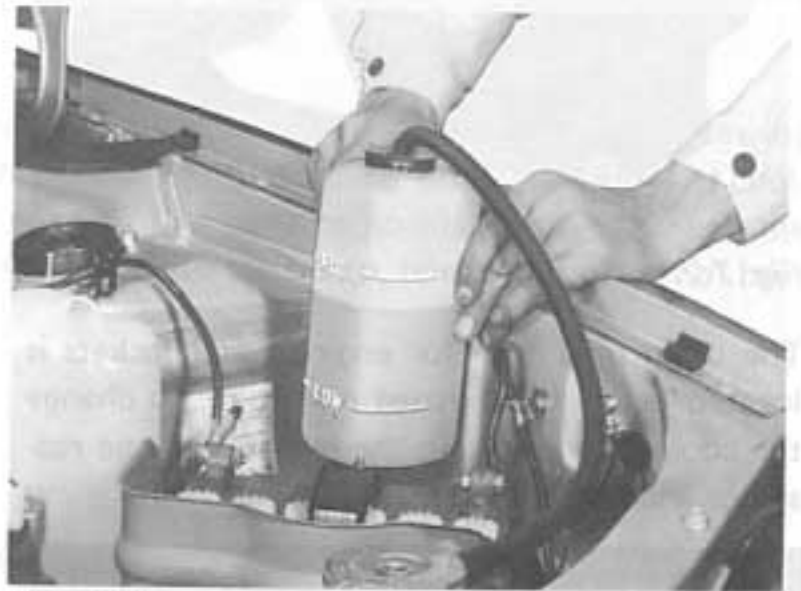


Fig. 7-7

## Thermostat

The temperature-sensitive material in the thermostat is a wax pellet. It is hermetically contained in a metal case, and expands and contracts according as the coolant temperature rise and falls. When it expands, the case pushes down the valve to open it.

If, during operation, the valve is suspected of remaining closed while it is expected to open increasingly, the cause is most likely a ruptured wax case.

In the top portion of the thermostat, an air bleed valve is provided; this hole is for venting out the gas or air, if any, that has accumulated in the coolant circuit.

Thermostat functional specifications	
Temperature at which valve begins to open	82° C (179° F)
Temperature at which valve becomes full open	95° C (203° F)
Valve lift	8 mm (0.31 in.)

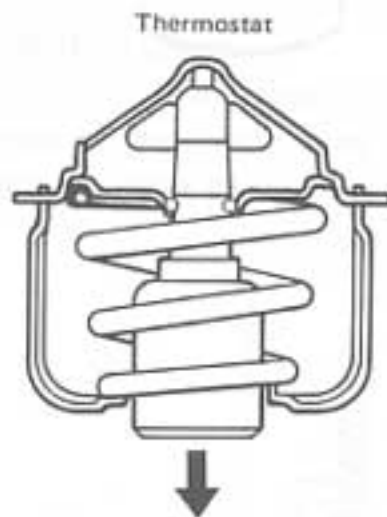


Fig. 7-8

## Radiator filler cap

This cap has two built-in valves and, by these valves, allows the internal pressure of coolant circuit to rise to a certain level slightly above that of the atmosphere.

Of the two built-in valves, one is an adjusting valve and the other is a negative-pressure valve. The former opens only when the internal pressure rises by 0.9 kg/cm<sup>2</sup>. This means that the coolant's boiling temperature is substantially above 100° C (212°F) - if the coolant is straight

Water - and that, under normal running condition, no boiling occurs to reduce the coolant's heat capacity.

Following a shutting down of the engine, the coolant will cool off and the internal pressure will drop. If the pressure should be allowed to keep on falling, there happens the danger of coolant pipes and radiator cores becoming subjected to a large collapsing pressure: the pipes or radiator cores or any weakest point might give in. The negative-pressure valve opens in such a case to admit atmospheric pressure into the coolant circuit, thereby avoiding a build-up of negative pressure.

The cap has its face marked "0.9", which means that its pressure adjusting valve opens at 0.9 kg/cm<sup>2</sup>.

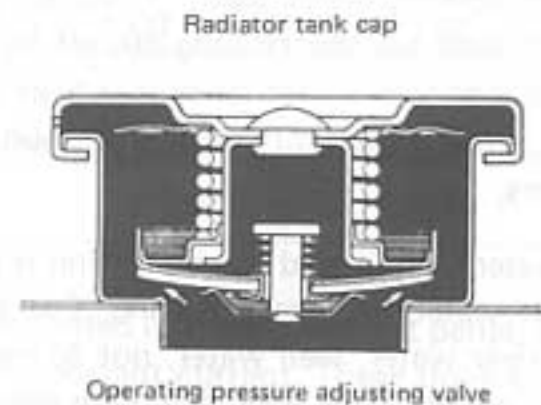


Fig. 7-9

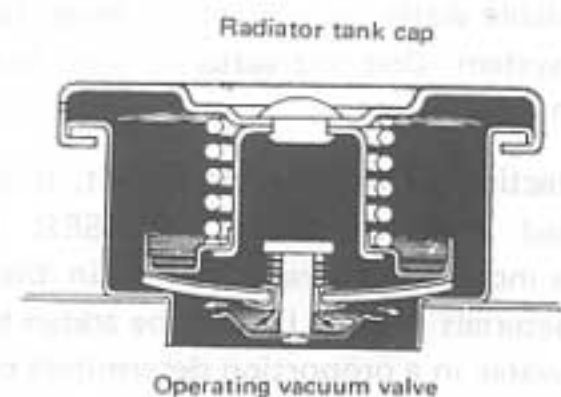


Fig. 7-10

## Water pump

The pump rotor is supported by a totally sealed bearing. The seals are of high-durability type and do not permit disassembly. For this reason, the pump must be replaced by a new one when any part of it has developed a malcondition of a kind that can be corrected in an ordinary water pump by disassembly and servicing.



Fig. 7-11

### Requirements on coolant

The long-term reliability and cooling capacity of the engine cooling system depends much on the quality of cooling water used. "Hard water," if used, will foul up the cooling circuit by scale formation, for such water is usually high in silicate and mineral contents. Scales are poor heat conductors.

Use of water high in acid concentration is just as bad; such water promotes rusting. For similar reasons, river water, well water, not to mention sea water, are not fit as engine cooling water.

Tap water available from city water supply is the best available water, in a practical sense, for the cooling system. Distilled water is ideal but is a luxury in most cases.

For protection of the cooling circuit, it is recommended that GOLDEN CRUISER 1200 (which is included as a regular item in the supply of materials from SUZUKI) be added to the cooling water in a proportion determined by the lowest atmospheric temperature expected.

Standard vehicles is shipped from the factory with its cooling circuit filled with a 30 % solution of GOLDEN CRUISER 1200; this solution does not freeze down to  $-16^{\circ}\text{C}$  ( $3^{\circ}\text{F}$ ).

Many brands of ANTI-FREEZE compounds are sold in the market. In no case, allow two or more different brands to be mixed in the cooling circuit of the engine.

GOLDEN CRUISER 1200 - "Anti-freeze and Summer Coolant" - its effects and use

(1) Effects of GOLDEN CRUISER 1200 coolant.

- (a) Its freezing temperature is much lower and depends on the concentration of GOLDEN CRUISER 1200. It is an anti-freeze coolant.
- (b) It does not corrode the metal surfaces of the cooling circuit. It is an anti-corrosion coolant.
- (c) It does not develop foam or bubbles. It is a foam-inhibited coolant.
- (d) It stands long usage. The renewal intervals is much longer.



Fig. 7-12





(2) How to proportion GOLDEN CRUISER 1200 to cooling water

GOLDEN CRUISER 1200 is a multi-purpose anti-freeze compound. Its aqueous solution as engine coolant can be kept in service as long as two years in a single stretch, regardless of changes of season.

To prepare an anti-freeze coolant with GOLDEN CRUISER 1200, proportion this compound to water according to the following chart, in which the proportions are indicated for seven levels of temperature as the lowest expected levels:

ANTI-FREEZE PROPORTIONING CHART

Freezing Temperature	°C	-9	-12	-16	-20	-25	-30	-36
	°F	16	10	3	-4	-13	-22	-33
GOLDEN CRUISER concentration	%	20	25	30	35	40	45	50
Ratio of compound to cooling water	Itr.	0.70/ 2.80	0.88/ 2.62	1.05/ 2.45	1.23/ 2.27	1.40/ 2.10	1.58/ 1.92	1.75/ 1.75
	US pt.	1.48/ 5.92	1.86/ 5.54	2.22/ 5.18	2.60/ 4.80	2.96/ 4.44	3.34/ 4.06	3.70/ 3.70
	Imp. pt.	1.23/ 4.93	1.55/ 4.61	1.85/ 4.31	2.16/ 4.00	2.46/ 3.70	2.78/ 3.38	3.08/ 3.08

**NOTE:**

Remember, the radiator capacity is 3.5 litres (7.40/6.16 US/Imp.pt.) which includes the reservoir tank capacity of 0.6 litre (1.27/1.06 US/Imp. pt.)

**Water temperature gauge**

This gauge constitutes a system of its own, with an indicator mounted in the instrument panel, an engine unit or sensor of thermistor type and a regulator for passing a constant current. These three-engine unit, indicator and regulator-are connected as shown in the diagram below:

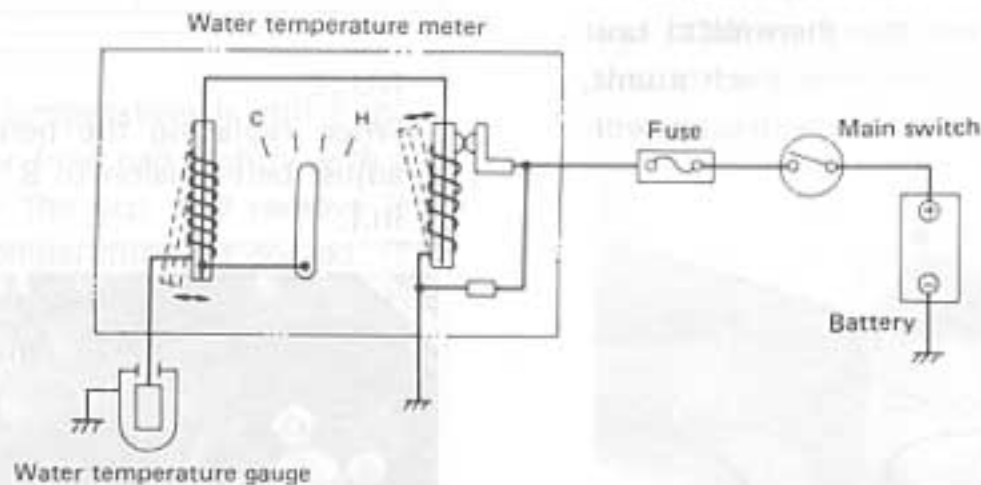


Fig. 7-13

The indicator is of bimetal type; its bimetal element is wrapped with a heater coil and becomes heated by the current flowing in the coil. By deflecting, the element actuates the indicating hand, making the hand move along the temperature scale.

The magnitude of the current is determined by the state of the thermistor in the engine unit. This unit is installed on the intake manifold. Speaking generally, a thermistor is a semiconductor resistive element whose ohmic resistance decreases as its temperature rises; its resistance has a negative temperature coefficient. When the coolant temperature rises, the thermistor offers a decreasing resistance, so that the current increases, thereby deflecting the indicating hand wider.

The regulator is a means of maintaining a constant current in the circuit for each ohmic resistance state of the thermistor, and does so function under the varying voltage condition of the battery.

## 7-5. Cooling System Services

### Thermostat

If the thermostat valve is suspected of malfunctioning, check first the possibility of some foreign matters being stuck on the valve seat to prevent the valve from seating tight. Next, check the thermostatic movement of the wax element in the following manner:

Heat water in a pan by placing the pan on a stove, as shown in Fig. 7-14. Grip the end of a thread or small string by pinching it in the valve and suspend the thermostat unit by holding the other end of the thread or string. Immerse it in the water, holding it about 20 mm (0.78 in.) above the bottom, and read the water temperature on the column thermometer.

If the suspended unit falls to the bottom (by releasing the gripped end of the thread or string) just when the temperature rises to 82° C (179° F) or thereabout (which is the temperature at which the valve should begin to open), the thermostat unit may be deemed to be in sound condition.

If the valve begins to open at a temperature substantially below or above, the thermostat unit should be replaced by a new one. Such a unit, if re-used, will bring about overcooling or overheating tendency.

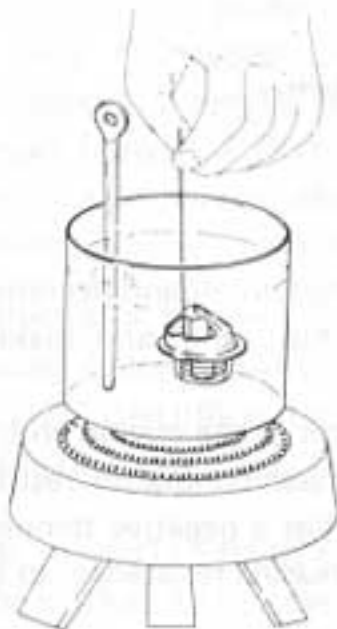


Fig. 7-14

Make sure that the air bleed valve of the thermostat is clear. Should this valve be clogged, the engine would tend to overheat.



Fig. 7-15

### Water pump belt

This belt drives both alternator and water pump. Check the belt for tension. The belt is in proper tension when a thumb pressure applied to the middle point of its span deflects it about 10 - 15 mm (0.4 - 0.6 in.). Inspect the belt for signs of deterioration and replace it as necessary.

Belt tension specification	10 - 15 mm (0.4 - 0.6 in.) as deflection
----------------------------	--

#### NOTE:

When replacing the belt with a new one, adjust belt tension to 8 - 10 mm (0.3 - 0.4 in.).

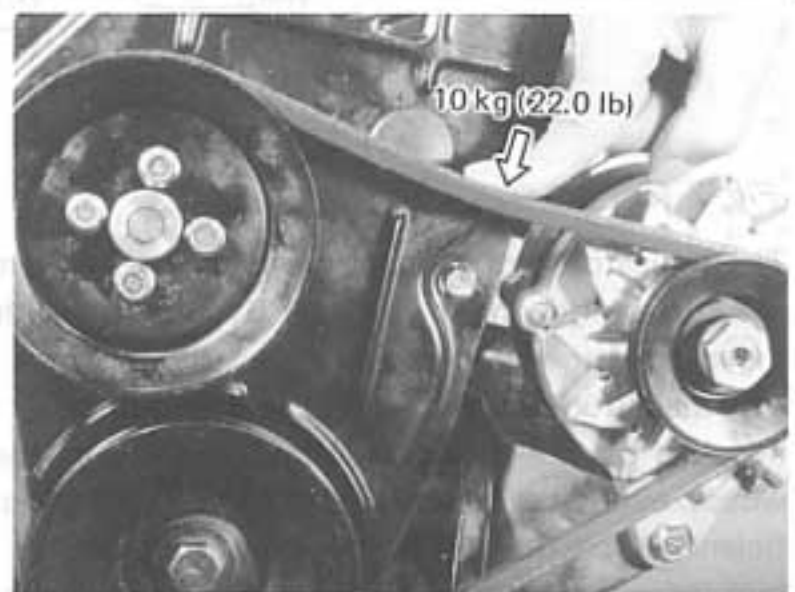


Fig. 7-16

To adjust the belt for proper tension, loosen the 3 bolts securing the generator in place, and displace it to slacken or tighten the belt.

A loose belt, or a belt tending to break off or otherwise defective, is often the cause of engine overheating. Because of the importance of this belt, it is strongly recommended that the belt be replaced at regular intervals even when the belt looks satisfactory in appearance.

Belt replacement interval	Two years (recommended)
---------------------------	-------------------------

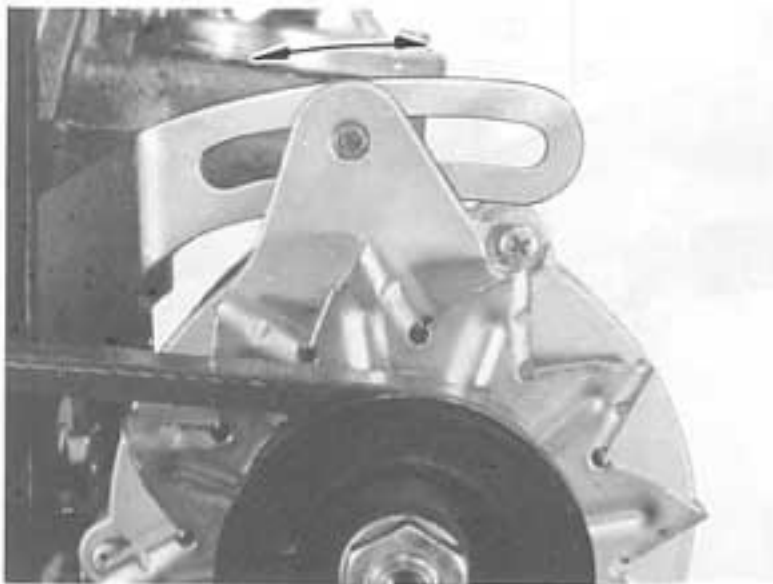


Fig. 7-17

### Radiator

**WARNING:**

When the water temperature is still high, loosen the radiator filler cap slightly with a cloth placed over the cap, and remove it after the water temperature has cooled. If the cap is removed while the water is hot, hot water will gush out and may cause burns.

If the water side of the radiator is found excessively rusted or covered with scales, clean it by flushing with the radiator cleaner compound.

This flushing should be carried out at regular intervals for scale or rust formation advances with time even where a recommended type of coolant is used. Periodical flushing will prove more economical.

Inspect the radiator cores and straighten the flattened or bent fins, if any. Clean the cores, removing road grimes and trashes.

Excessive rust or scale formation on the wet side of the radiator lowers the cooling efficiency. Flattened or bent fins obstruct the flow of air through the core to impede heat dissipation.

Radiator flushing interval	Two years (recommended)
----------------------------	-------------------------

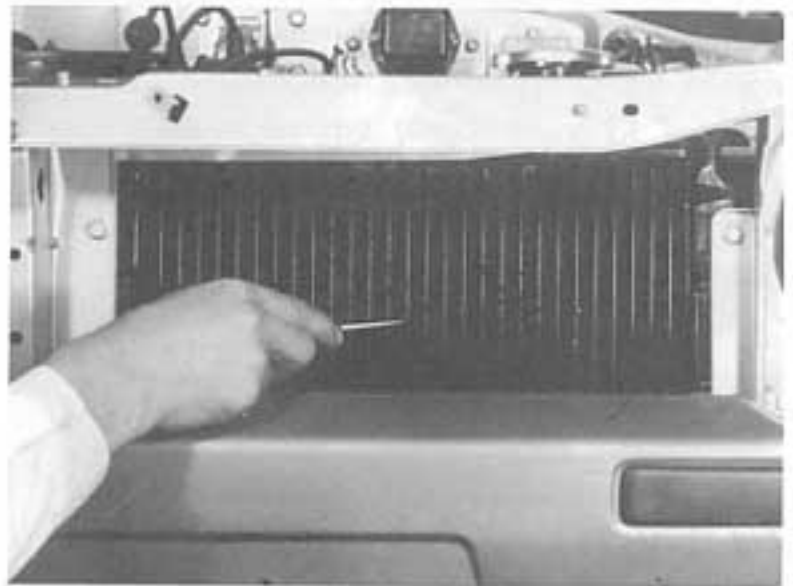


Fig. 7-18

### Coolant level

Cooling water in service decreases its volume gradually on account of progressive loss due to water evaporation. Check to be sure that the water surface is up to anywhere between FULL and LOW marks on the reservoir tank. The user should be reminded of the need to daily check the water level.



Fig. 7-19



### Water hoses

Inspect each water hose for evidence of cracking or breakage, and be sure that its connection is tight. A defective hose or a hose showing signs of malcondition must be replaced. Tighten the hose connections as necessary.

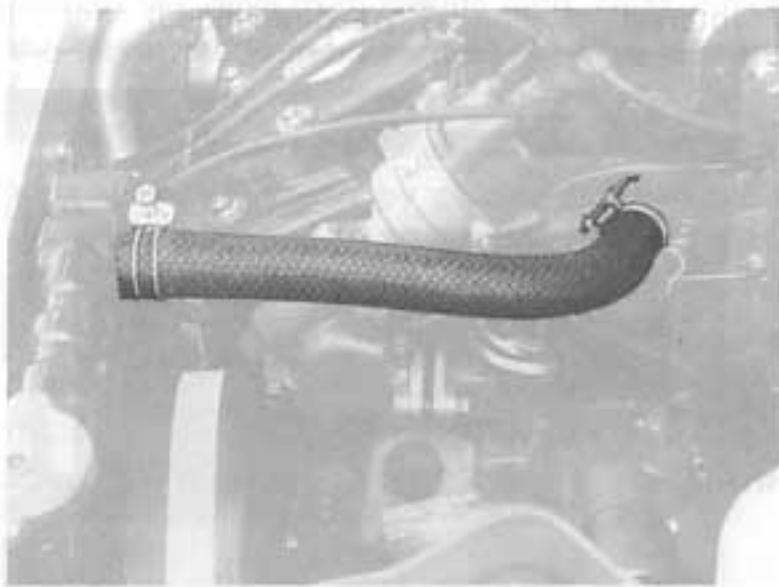


Fig. 7-20

## 7-6. Important Re-installing Steps

### Filling up the cooling system

Park the machine on a flat level floor, and fill in until you see the coolant come up to the well part of the radiator filler. Then, run the engine two or three minutes to recirculate the coolant. This recirculation will drive out air, if any, trapped inside, and will lower the coolant surface at the filler. Add coolant until its surface shows up again in the filler, and fill up the reservoir tank, raising the surface to FULL mark.



Fig. 7-21

## 7-7. Cooling Blower Motor

Circuit of the cooling blower motor is shown below.

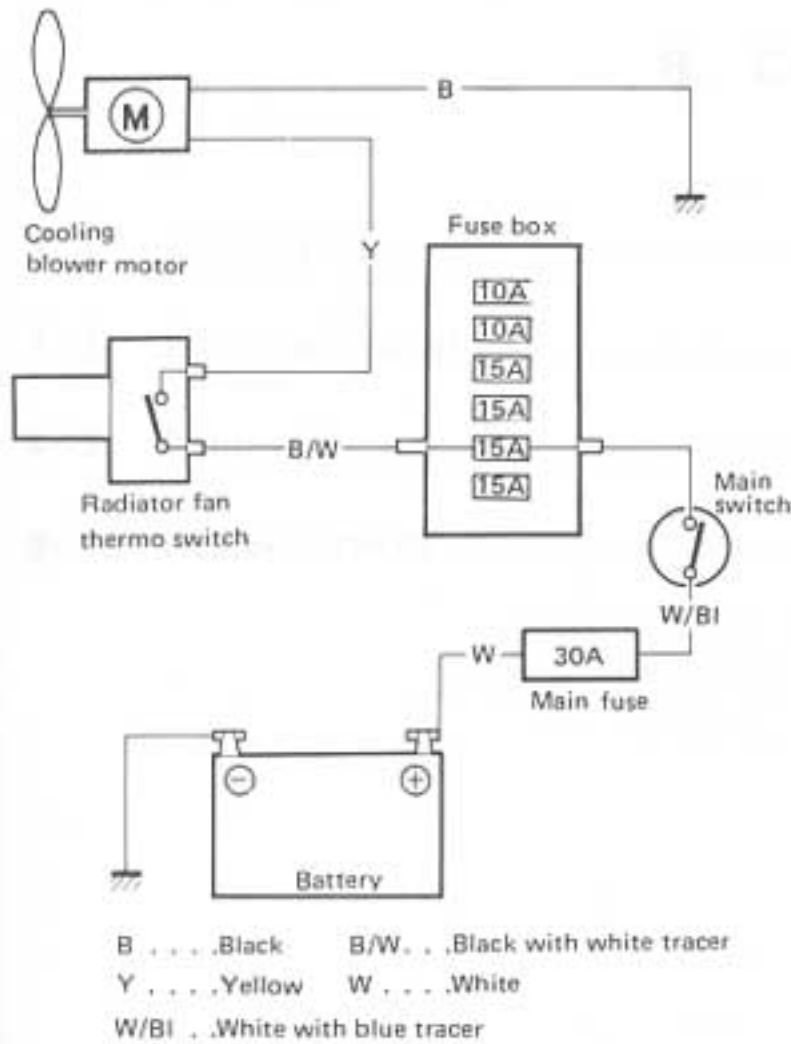


Fig. 7-22

When the water temperature goes up to 86-90° C (186 - 194° F), the thermostick of the cooling blower motor is switched on, and the motor starts to run. When the water temperature falls to 81 - 85° C (177 - 185° F), the blower motor stops.

The blower motor forcibly cools the engine when ambient cooling is insufficient: for example, in the summer, when running up a long slope at low speed or running for a long time at low speed, etc.

## Inspection

### Radiator fan thermo switch

- 1) Remove the thermo switch from radiator.
- 2) Heat water in a pan by placing the pan on a stove, as shown in Fig. 7-23.
- 3) Immerse the switch in hot water keeping the coupler joint part ① above the water surface.
- 4) In the above 3) state, connect the tester terminals ⊕ and ⊖ with the coupler joint part and check for continuity. If the switch conducts when the temperature of the hot water rises as high as 86 - 90°C (186 - 194° F) and it doesn't when the temperature falls down to 81 - 85°C (177 - 185° F), it is in good condition.

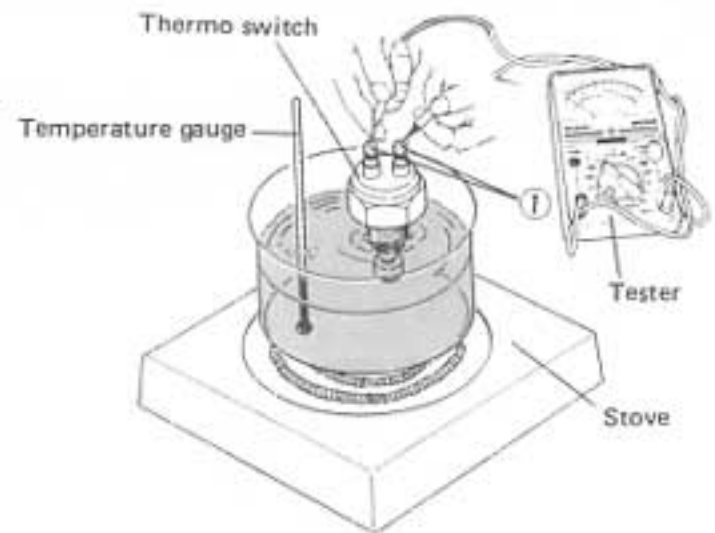


Fig. 7-23

## 8-1. Description

The car heater is of a hot water type and operates quietly. The air is heated by the engine coolant and the warm air is blown into the car interior by the blower motor.

The blower motor is driven electrically, independent of engine speed, and operates effectively even when the engine speed is low.

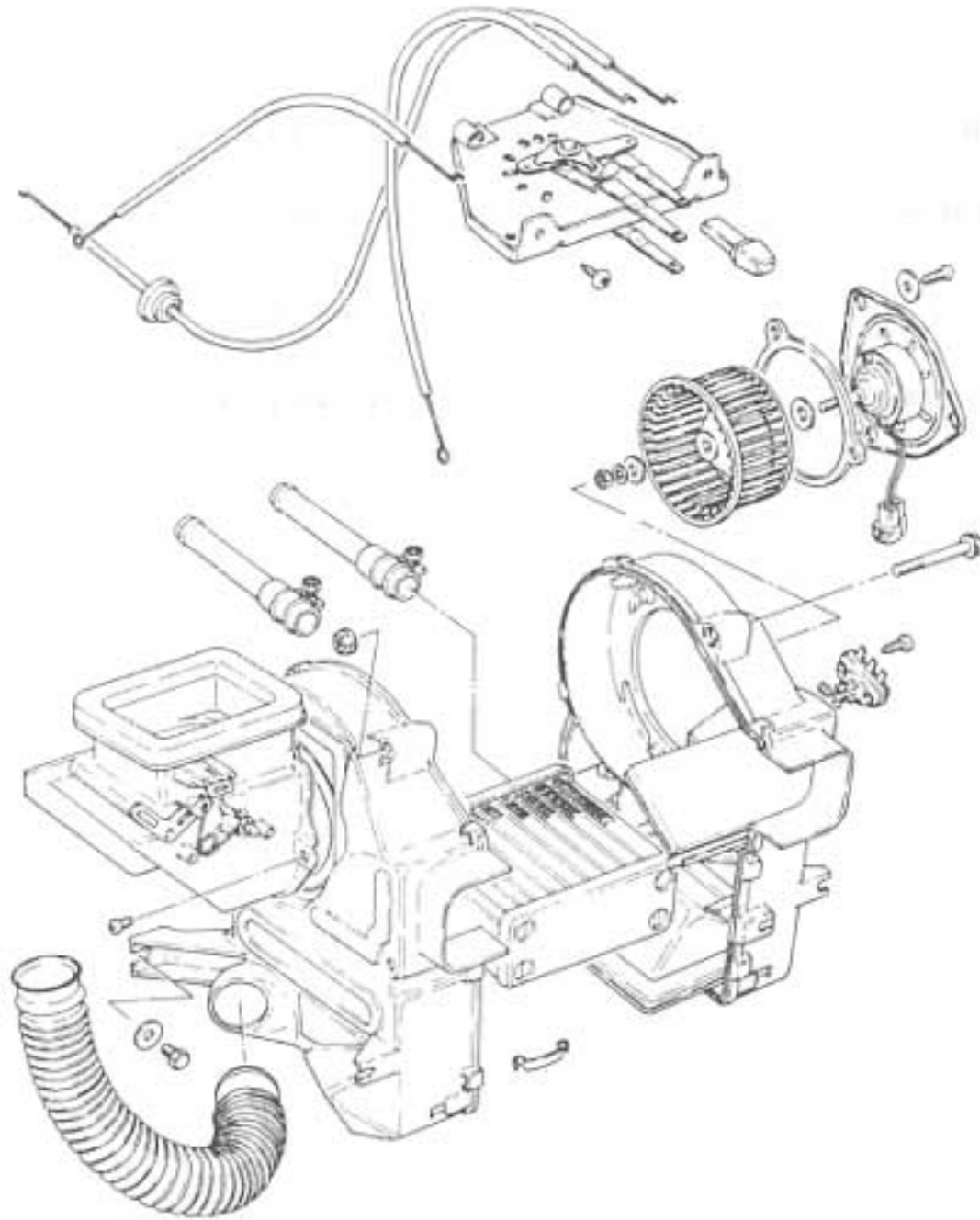


Fig. 8-1

## 8-2. Electrical Circuit

The circuit diagram (Fig. 8-2) shows how the blower motor is controlled. Turn the main switch to "ON", pull the fan switch knob out one step, and voltage is applied across the blower motor. The current is small because of the resistor provided in the circuit (indicated as "fan resistance" in the diagram). Under this condition, the blower runs slowly. By pulling the fan switch knob fully out, the battery voltage is applied across the blower motor, a large current flows and the blower motor runs at full speed.

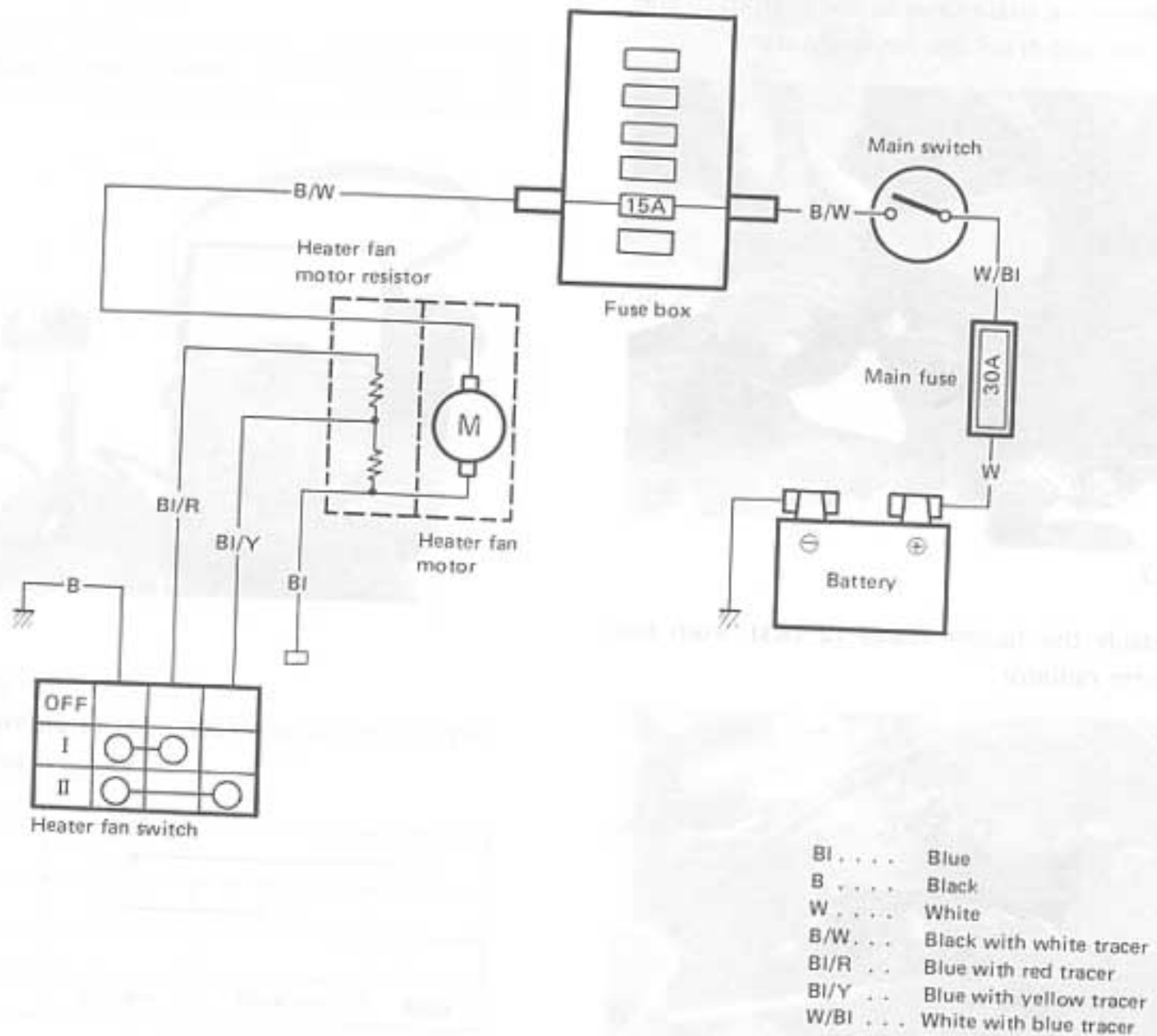


Fig. 8-2

### 8-3. Removal

#### Fan resistor

The fan resistor has been installed on the right side of the heater box. Disconnect the lead wire at the coupler and remove the resistor from the box.

#### Heater radiator

- 1) Unscrew the drain plug at the bottom of the radiator and drain the cooling water.

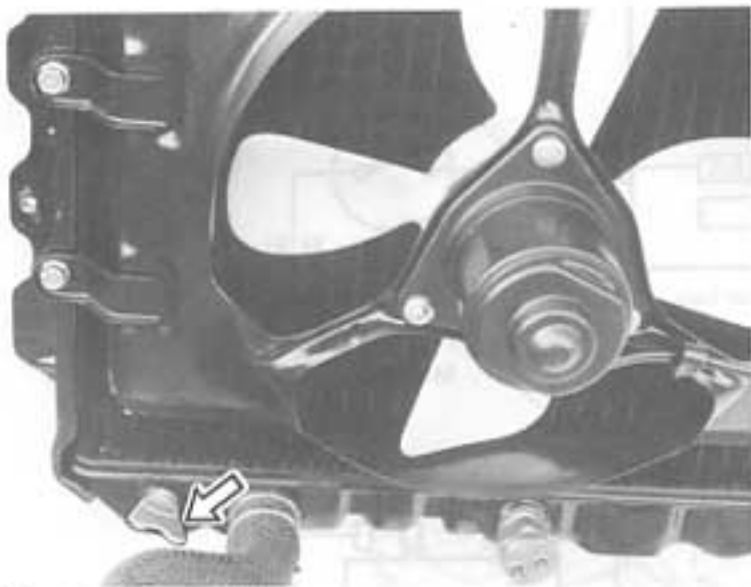


Fig. 8-3

- 2) Detach the heater hoses (2 pcs) from the heater radiator.



Fig. 8-4

- 3) Remove the heater box.



## 8-4. Heater Services

### Fan resistor

This resistor is on the heater case right side. Inspect it for signs of cracking or breakage and replace it as necessary. If the blower motor will not run or when you replace the existing resistor, check to be sure the total resistor has an ohmic resistance of about several ohms. Use a circuit tester for this purpose.

Fan resistor specification	Several ohms
----------------------------	--------------

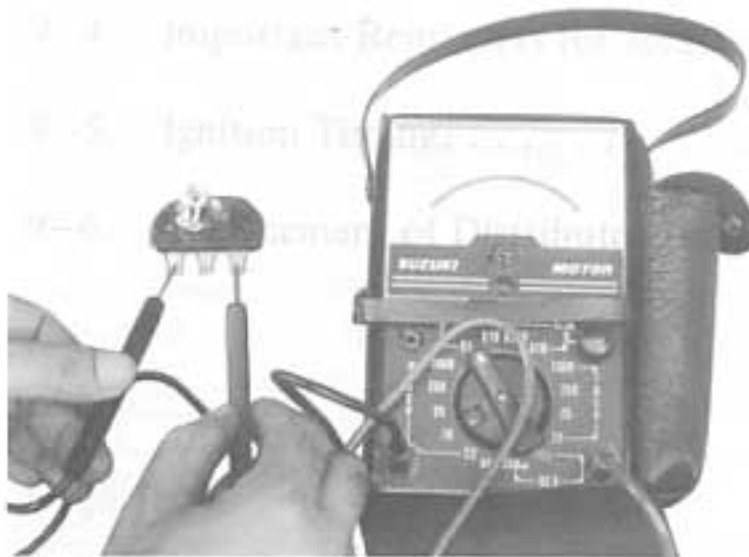


Fig. 8-5

### Fan switch

Using a circuit tester, check this switch for circuit continuity:

II	○	—	○
I	○	—	○
OFF			
	Yellow	Blue/red	Blue

### Heater hoses

Check the heater hoses for the connection condition, breakage, cracks and other damage and replace if necessary.

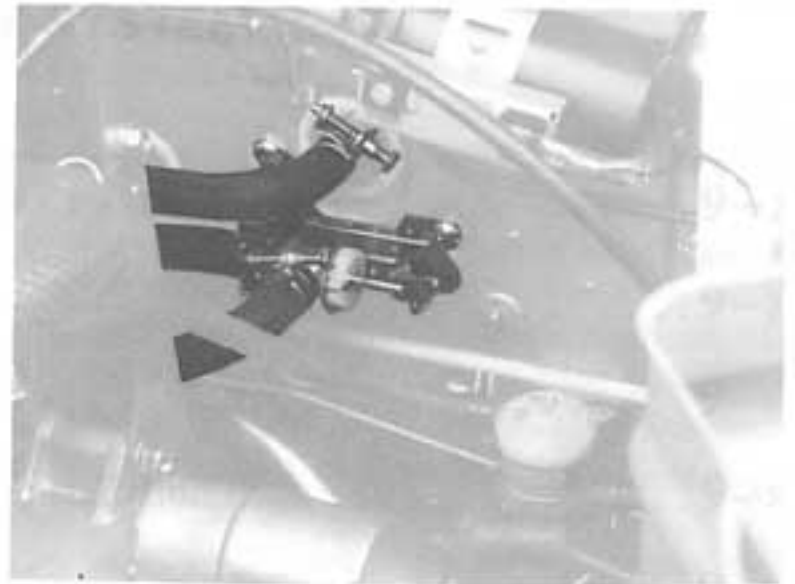


Fig. 8-6

## 9-1. Description

The principal components of the ignition system are, as shown in the circuit diagram of Fig. 9-1, the spark plugs, distributor, contact-breaker, ignition coil and, as the source of igniting energy, the battery. Note that the ignition coil has two windings, primary and secondary.

Current from the battery flows through the primary winding and then the contact-breaker; the contact point in the breaker opens and closes to interrupt this current intermittently.

Each time the primary current is interrupted, a very high voltage develops in secondary winding. It is this intermittent high voltage that the distributor passes sequentially to the three spark plugs to fly a spark across the gap in each, one plug a time.

The distributor is sort of rotary switch, whose rotor connects the three plugs, one at a time, to secondary winding of the ignition coil through the wires called "high-tension" cords. Note that there are one high-tension cord, from secondary winding to the center of the distributor cap, and three more high-tension cords between the spark plugs and the three terminals on the cap.

The resistor, connected in series to primary winding, serves to reduce the inductance of primary winding so that the high voltage generation in secondary winding will be stabilized.

### NOTE:

Whereabouts of terminal connections are clearly indicated in the diagram below. When inspecting the electrical wiring, refer to this diagram and check to be sure that each connection is tight. Examine the cords for torn insulation and for evidence of grounding.

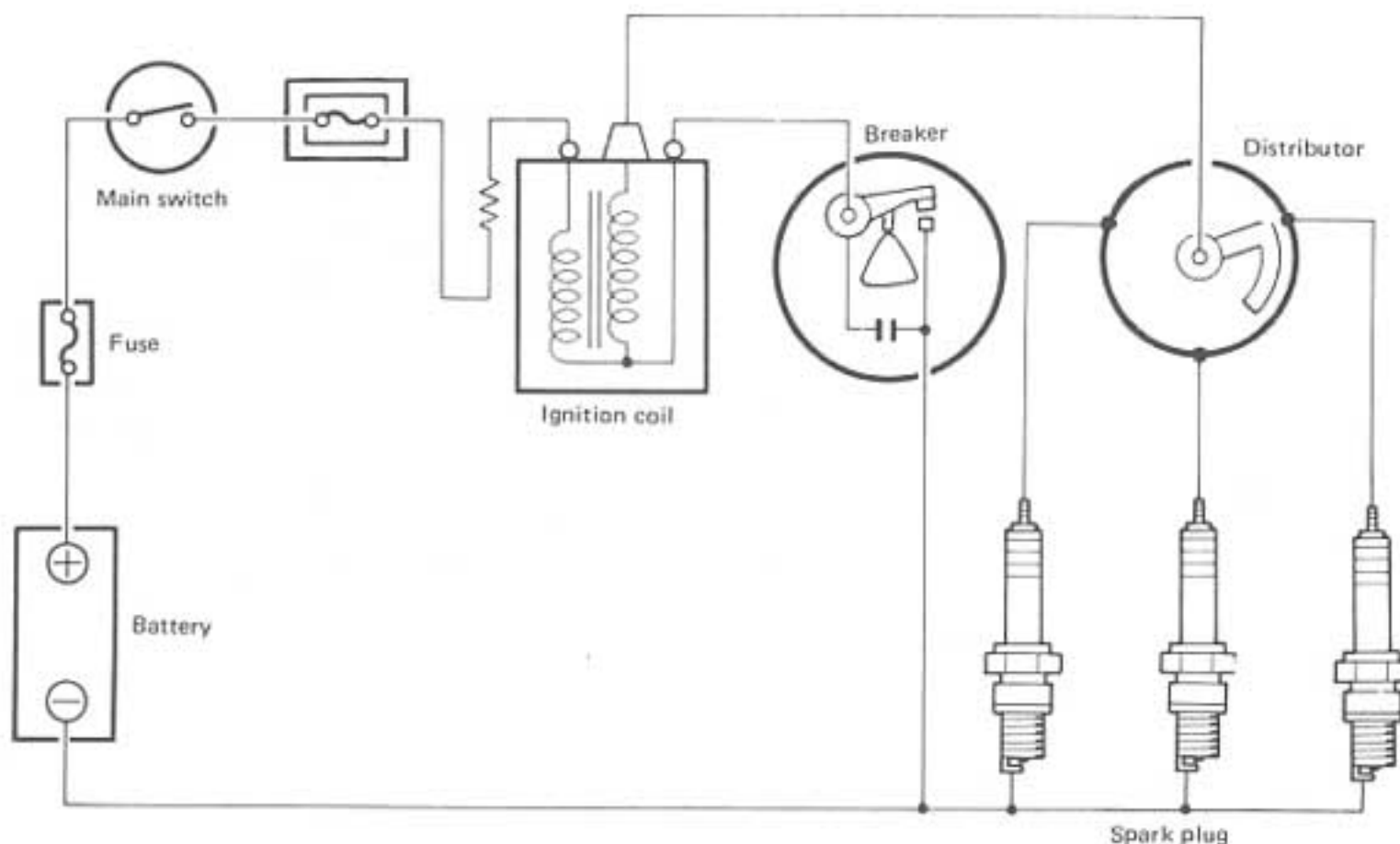


Fig. 9-1

## 9-2. Description of Components

### Distributor

Fig. 9-2 shows the distributor unit in section to expose its internal mechanisms to easy viewing. The shaft is driven from engine camshaft through worm gearing, and rotates once for every two revolutions of the crankshaft.

Inside the cap are three side electrodes (for spark plugs) and one center electrode (to which the secondary side of the ignition coil is connected). The arm of the rotor, mounted on the shaft, touches the side electrodes one by one "distribute" the high voltage to the spark plugs.

Immediately below the distributing mechanism is the contact-breaker, whose cam, mounted on the shaft, actuates the breaker arm to make and break the primary current circuit for the purpose already mentioned. The condenser (capacitor) secured to the distributor body is for absorbing the current surge, which would otherwise result in a sparking across the contact point gap. The surge occurs every time the contact point is opened, and is due to, so to say, the inertia of electric current. The object served by the condenser is obvious; it is to prevent the point faces from getting burnt by sparking.

The ignition is advanced automatically by centrifugal action and by the difference between carburetor vacuum and atmospheric pressure. How the advancer operates will be described in reference to Figs. 9-4, 9-5, 9-6 and 9-7.

Distributor data	
Cam dwell angle	$62^{\circ} \pm 2^{\circ}$
Condenser capacitance	0.25 microfarad
Ignition timing	10° B.T.D.C. below 950 r/min
Number of gear teeth	13
Direction of rotation	Clockwise, as viewed from top

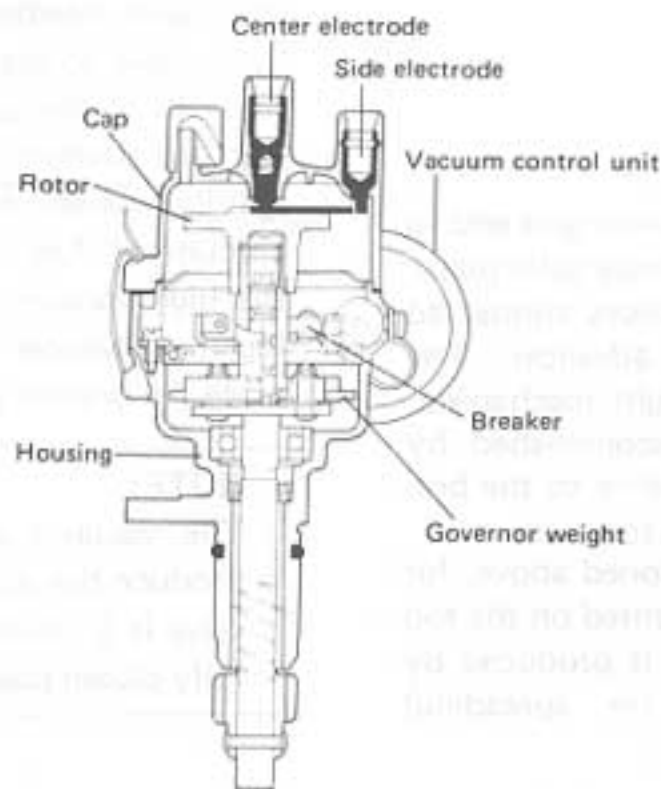


Fig. 9-2

### Ignition coil

The ignition coil is a sort of miniature transformer and, as such, has an iron core around which two coils are wound — primary and secondary windings mentioned above. The two are so close to each other that a sudden change in the magnetic flux produced by "primary current" flowing in primary winding (in a less number of coil turns) induces a very large electromotive force (voltage) in secondary winding (in a greater number of coil turns). These live parts are housed in a tight, insulator case topped by the cap mentioned above. Note that the cap has three terminals: one high-tension terminal and two low-tension terminals.

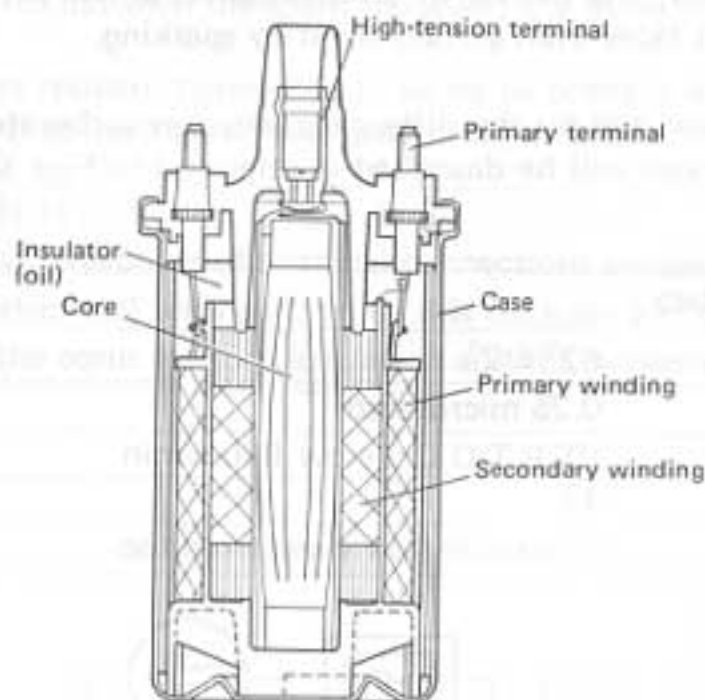


Fig. 9-3

### Timing advancer

The distributor shaft, from its driven-gear end to the rotor-carrying end, is not a single solid piece; actually this shaft is in two pieces connected together through the timing advancer. The advancer is essentially a flyweight mechanism. Timing advancing action is accomplished by twisting the top shaft piece relative to the bottom one in the direction of shaft rotation.

The contact-breaker cam, mentioned above, for actuating the breaker arm is mounted on the top piece. The twisting movement is produced by the speed-dependent radial (or spreading) movements of the two flyweights.

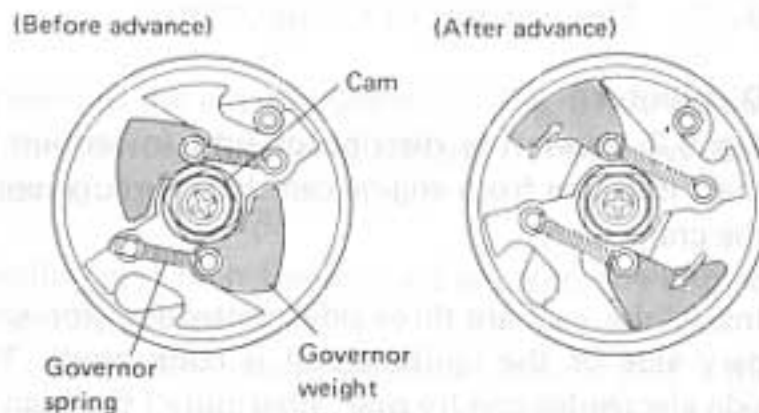


Fig. 9-4

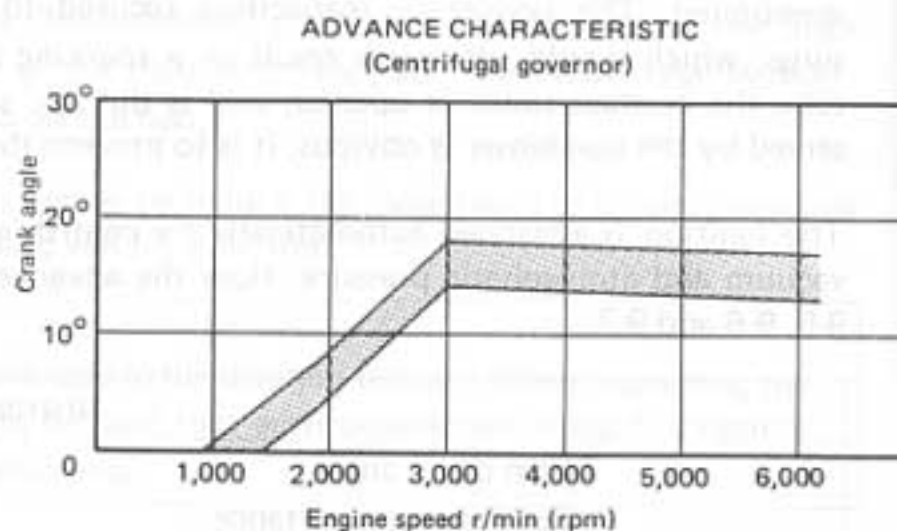


Fig. 9-5

### Vacuum advancer

When the engine is in lightly loaded condition, the amount of fuel being supplied to it is not much and, needless to say, throttle valve is open but a little, so that the vacuum in the inlet manifold side of the carburetor is high.

For fuel economy, it is desirable to advance the ignition when the engine is burning a small amount of fuel. The vacuum advancer utilizes the high vacuum to produce a force for actuating the advancer rod in order to angularly displace the breaker plate.

#### NOTE:

The vacuum advancer starts working to produce the advancing force when throttle valve is 5° to 6° open as measured from its fully closed position.

The diaphragm is spring-loaded. With a high vacuum, the differential pressure acting on the diaphragm causes to overcome the spring force and move in the direction for pulling the advancer rod. The rod so pulled turns the breaker plate counterclockwise (counter to the direction of distributor shaft rotation) to advance the ignition.

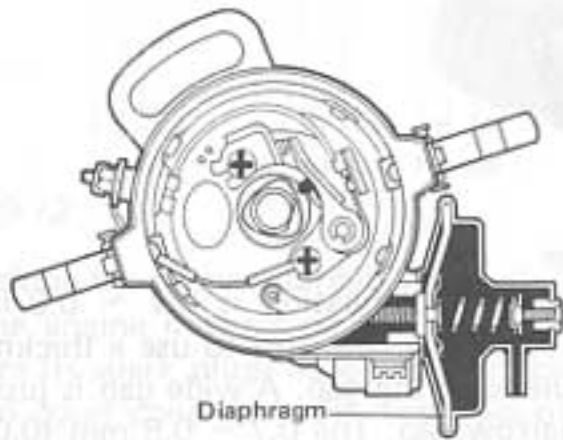


Fig. 9-6

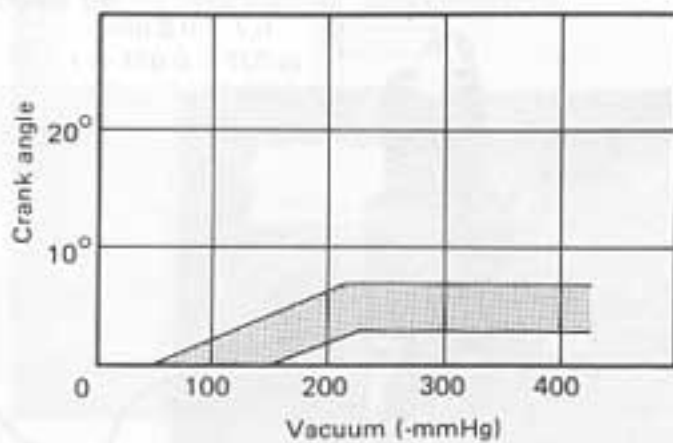


Fig. 9-7

### Spark plugs

Each new machine shipped from the factory is fitted with standard plugs.

	Hot type	Standard
NGK	BP 5EA	BP 5ES
Nippon Denso	W14EX-U	W16EX-U

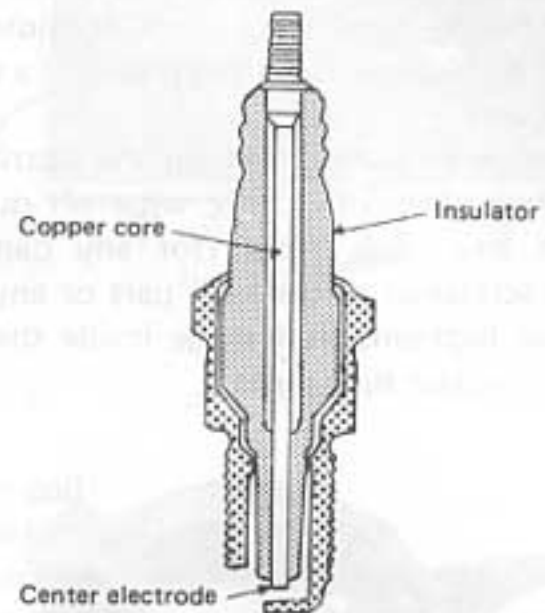


Fig. 9-8



### 9-3. Maintenance Services

#### Distributor cap

Leadage of high-tension energy for ignition shows up as misfiring in the engine. It occurs at any part of the high-tension line where insulation has failed or in a dirty distributor cap, that is, an internally dirty cap.

A wider spark gap in the plug, a condition often found in poorly cared spark plugs, promotes the tendency of high-tension energy to find a short-cut to ground.

Cleanliness is very important for the distributor cap. With a clean dry cloth, wipe off dust or grime, if any, and inspect for any damaged (scarred, scratched or cracked) part or any part evidencing high-tension leakage inside the cap. Be sure to replace such parts.



Fig. 9-9

#### Distributor driven gear

Inspect the gear teeth for wear, and see if the backlash is normal or not. Excessive backlash can be told by turning the shaft back and forth, with its driven gear in mesh with driving gear. Maladjusted ignition timing is often due to excessive tooth wear in this gearing and, in such a case, can be corrected by replacing the driven gear.



Fig. 9-10

#### Spark plugs

The spark gap specification is 0.7 ~ 0.8 mm (0.027 ~ 0.031 in). Be sure to use a thickness gauge in checking the gap. A wide gap is just as bad as a narrow gap. The 0.7 ~ 0.8 mm (0.027 ~ 0.031 in) gap will produce the right kind of sparks needed by the air-fuel mixture in this engine.

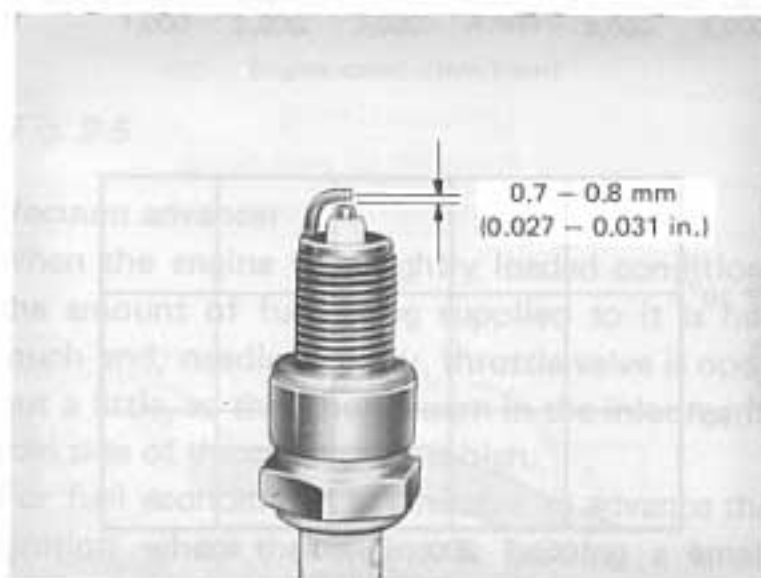


Fig. 9-11

#### Contact point faces

In the contact breaker, push the breaker arm with your fingertip just a little so that you can see the point faces. If the faces are oily, clean; if roughened, smoothen by grinding. In most cases, the point faces can be reconditioned by grinding with a file or oil stone. Points worn beyond repair must be replaced.

The illustration, below, tells what must be done in each case but the last one showing a pair of properly aligned, smooth faces. Wear or burning is hard to occur in the contact point whose point faces are in the condition labeled "good."

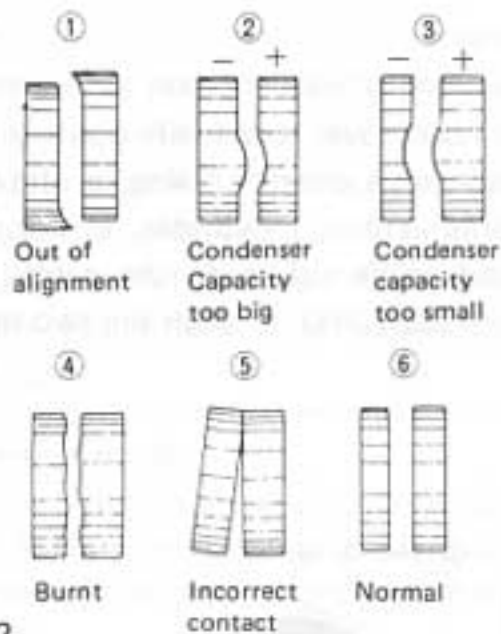


Fig. 9-12

### Checking the primary circuit for fault

If the engine misfires or does not fire up at all where its spark plugs have just been checked to be in good condition, the first step of locating the cause is to check the primary circuit (between distributor and ground) for continuity by using a circuit tester as shown. Since the contact point is open, the tester should indicate discontinuity (infinitely large resistance); if continuity is noted, it means that there is a fault somewhere along the primary circuit, which could be in condenser or elsewhere.

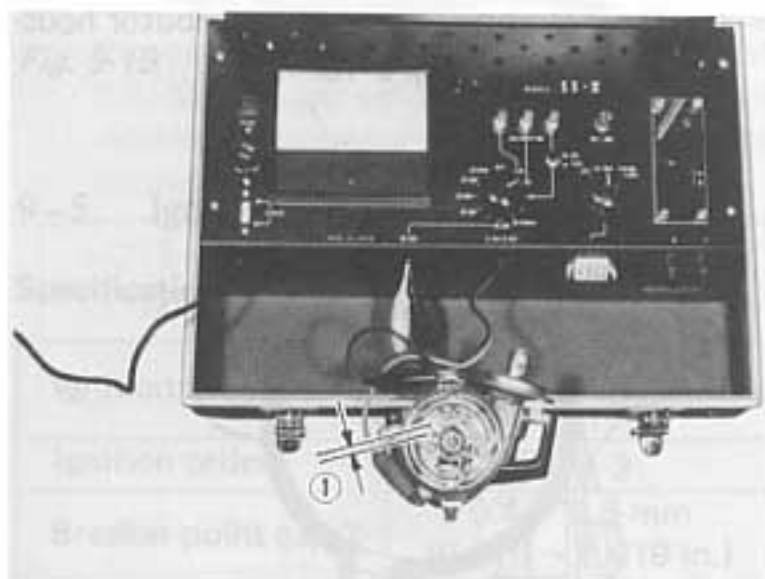


Fig. 9-13

### Condenser

Check the condenser for capacitance by using the electro-tester. You may do so with the condenser in place or removed. When checking it in place, that is, as mounted on the distributor, be sure to have the contact point opened. A condenser not meeting the following capacitance specification must be replaced:

Condenser capacitance specification	0.25 microfarad
-------------------------------------	-----------------

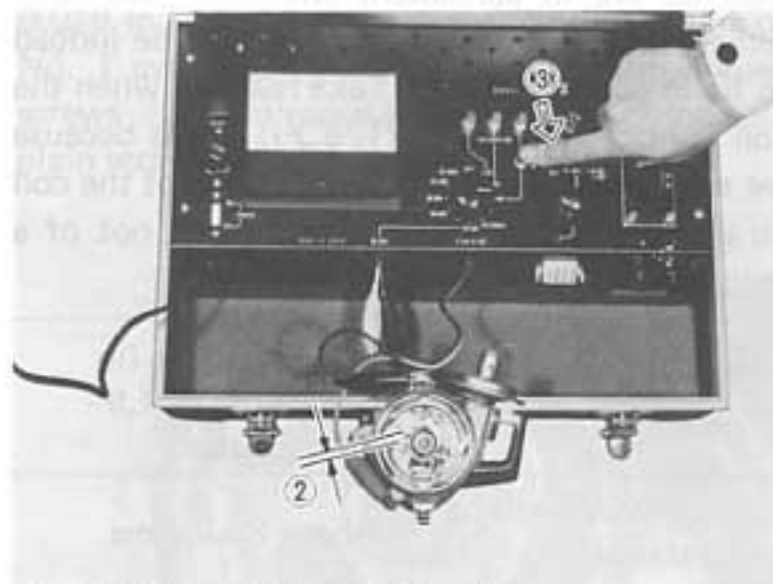


Fig. 9-14

### Ignition coil

#### (1) Sparking performance test

The purpose of this test is to see if the ignition coil is capable of producing high voltage surges forceful enough to fly good sparks at the ignition coils at all times, particularly when its temperature has risen to the normal operating level. Use of the electro tester is assumed for this test. With the ignition coil connected to the tester, as shown, let the spark fly across the three-needle gap. Continue this testing for about three minutes so that the coil will get warm to simulate the normal operating condition. The coil may be deemed to be in good condition if the sparking is stable, without any misses. In the use of the electro tester for this purpose, do not enlarge the three-needle gap wider than 7 mm (0.27 in.)

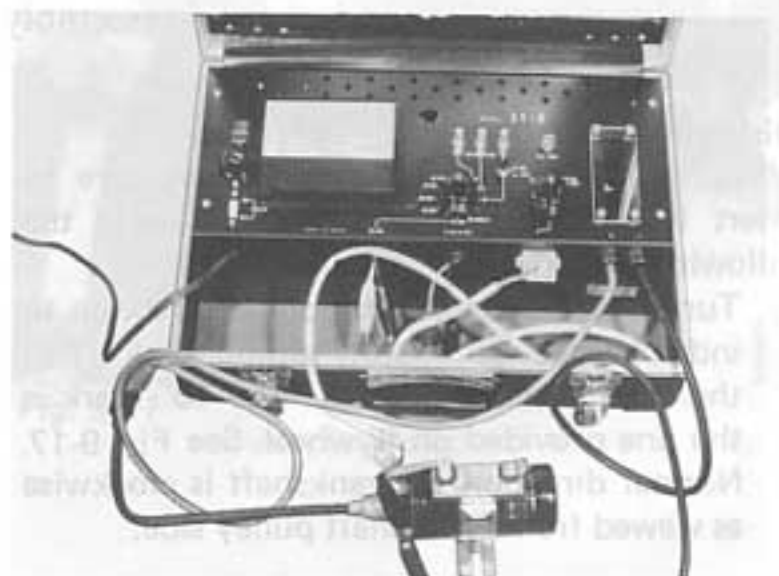


Fig. 9-15



## (2) Resistance measurement

Measure the ohmic resistances of primary and secondary windings in the ignition coil. If the readings are in agreement with the prescribed values, indicated below, the coil may be judged to be in good condition. Take readings when the coil is hot, about 80°C (176°F); this is because we are interested in the performance of the coil at the normal operating temperature, not of a cold coil.

Primary winding resistance	About 3 ohms (in clusive of the 1.5 - ohm resistor)
Secondary winding resistance	About 8 kilohms

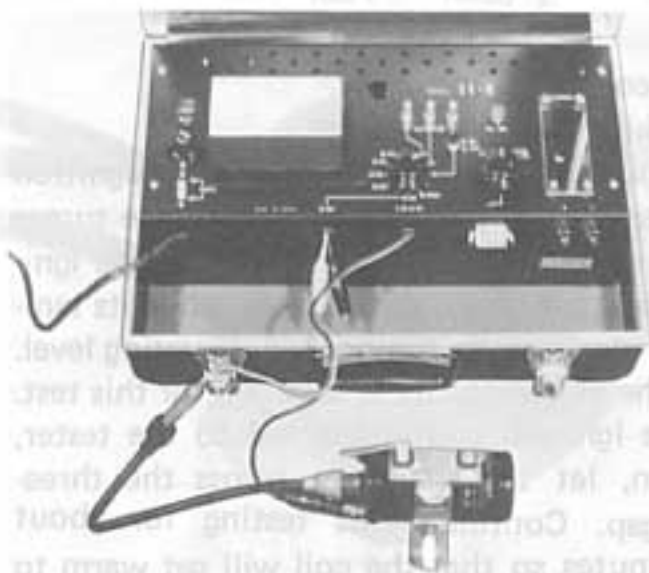


Fig. 9-16

## 9-4. Important Reminders for Reassembly and Installation

### Distributor

When re-installing the distributor, be sure to insert it into the distributor gear case in the following sequence:

- 1) Turn over crankshaft in normal direction to index the 10° (B.T.D.C.) timing mark ① to the timing match bolt ②. The 10° mark is the one provided on flywheel. See Fig. 9-17. Normal direction of crankshaft is clockwise as viewed from crankshaft pulley side.

### CAUTION:

After aligning marks ① and ②, remove cylinder head cover to visually confirm that the rocker arms are not riding on the camshaft cams at No. 1 cylinder. If the arms are found to be riding on the cams, turn over crankshaft 360° to align the two marks anew.

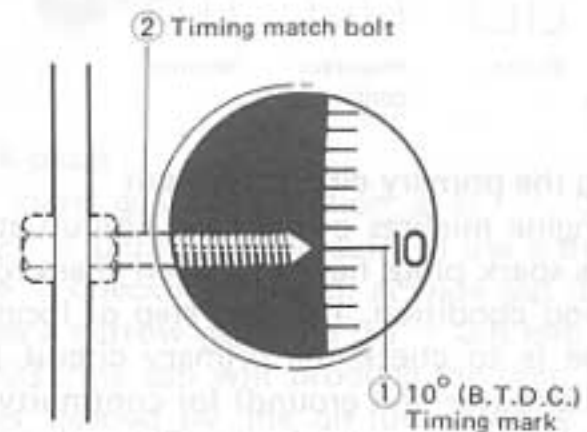


Fig. 9-17

- 2) Remove the distributor cap. Turn the rotor to make the center ③ of rotor flush with mark ④ embossed on the distributor housing, as shown in Fig. 9-18.

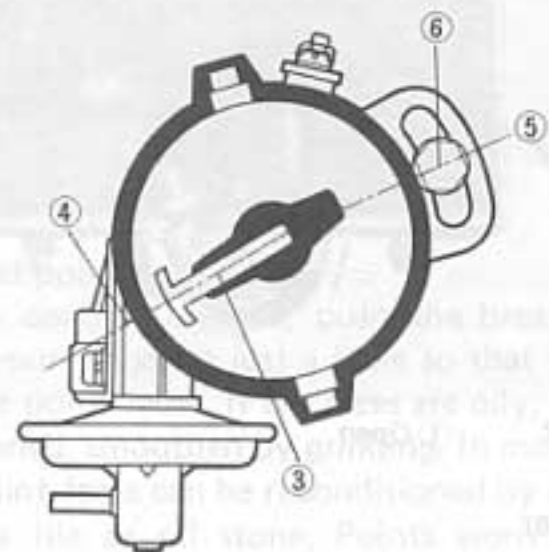


Fig. 9-18

3) Feed the distributor into the gear case in such a way that the center ⑤ of distributor flange will coincide with the distributor mounting screw hole ⑥ provided in the distributor gear case. Secure the distributor in place tentatively by making the mounting screw finger-tight, and adjust the ignition timing.

#### High-tension cords

Install the three high-tension cords by referring to Fig. 9-19, making sure to identify the three cap terminals of the distributor for the three cylinders.



Fig. 9-19

### 9-5. Ignition Timing

#### Specifications

Ignition timing	10° B.T.D.C. below 950 r/min
Ignition order	1 → 3 → 2
Breaker point gap③	0.4 ~ 0.5 mm (0.016 ~ 0.019 in.)

#### Checking methods

Check to be sure that the point gap is within the specified range, from 0.40 to 0.50 mm (0.016 ~ 0.019 in.) and then check the ignition timing on No. 1 cylinder. To adjust the point gap, loosen screws ① and move the stationary point with plain screwdriver inserted into slit ②.

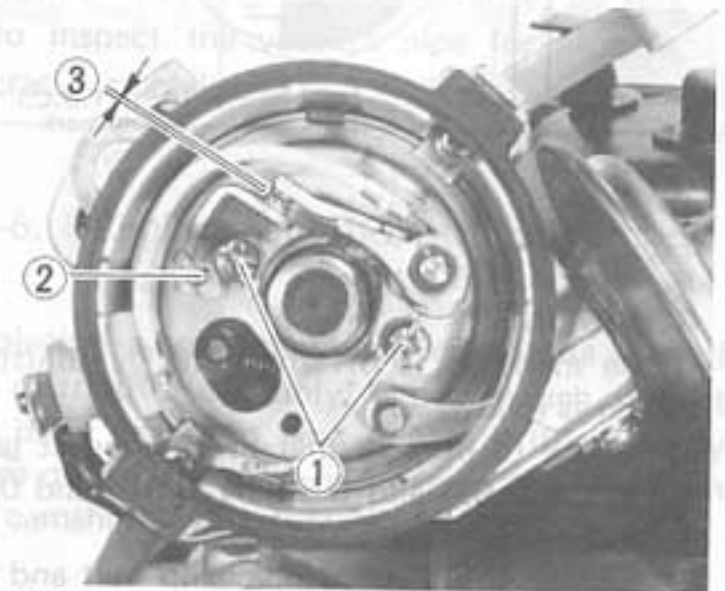


Fig. 9-20

(1) Checking and adjusting with timing light  
CHECKING:

Tie the light to No. 1 high-tension cord. Start up the engine and run it at a speed not higher than 950 r/min. Under this condition, direct the light to the flywheel. If the 10° timing mark ④ appears aligned to the timing match bolt ⑤, the ignition is properly timed. See Fig. 9-22.



Fig. 9-21

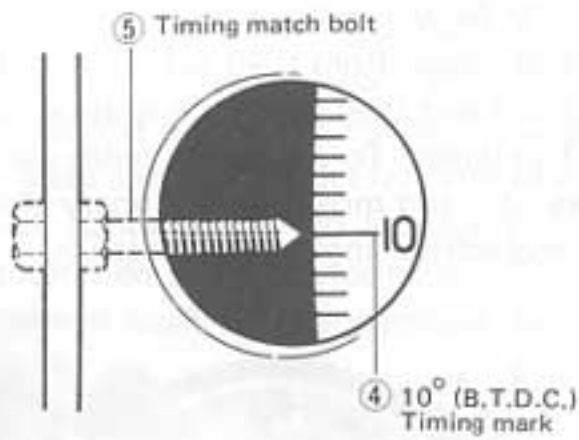


Fig. 9-22

**ADJUSTING:**

If the mark ④ is off the bolt ⑤, adjust the timing as follows:

- 1) Check to be sure that breaker point gap is between 0.4 and 0.5 mm (0.016 and 0.019 in.).
- 2) Loosen the distributor clamp bolt and turn the distributor housing in place to advance or retard the timing.

**NOTE:**

- Turning the housing counterclockwise advances the timing, and vice versa.
- After repositioning the housing, check the timing with the timing light and, as necessary, repeat step 2).

(2) Checking and adjustment with the timing tester

The timing tester has a built-in buzzer. Connect one of its leads to the primary-circuit terminal of the distributor and the other lead to the distributor body. Slowly turn the crankshaft clockwise as viewed from crankshaft pulley side while watching the timing marks. (have the ignition switch turned off.)

The buzzer should start sounding off just when the marks come into register, indicating that the engine is set for the specified timing.

**CAUTION:**

With timing marks ④ ⑤ lined up as shown in Fig. 9-23, remove the cylinder head cover and check to be sure that No.1 cylinder rocker arms are not riding on cam lobes. If the arms are up, turn over crankshaft by one rotation (360°) clockwise (as viewed from crankshaft pulley side). This turning should cause the buzzer to sound off just when the marks come into alignment.

**NOTE:**

The two tester leads are given polarity signs, (+) to one and (-) to the other lead: connect the red lead to (+) cord, and the black lead to (-) cord, of the distributor.

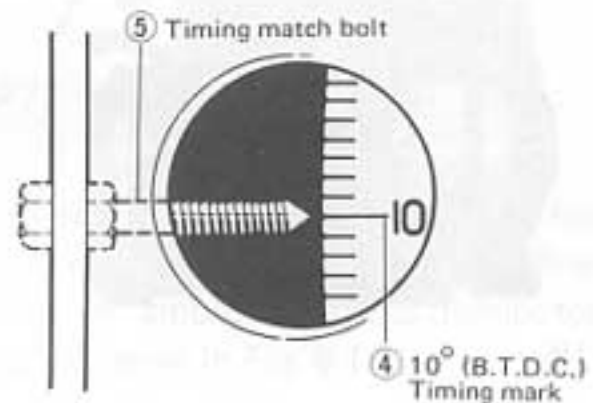


Fig. 9-23



Fig. 9-24 Ⓐ Timing tester (09900-27003)



## ADJUSTING:

Upon noting that the ignition is not timed to the specification, proceed as follows:

- 1) Make sure that the breaker point gap is set right, that is, between 0.4 and 0.5 mm (0.016 - 0.019 in.).
- 2) Bring timing mark ④ into alignment with mark ⑤, as shown in Fig. 9-23. Mark ④ represents the 10° crank angle.
- 3) Loosen the distributor clamp bolt, and slowly rotate the distributor housing until the buzzer starts sounding off. Hold the distributor right there and tighten the clamp bolt.

### NOTES:

1. Turning the housing counterclockwise advances the timing and vice versa.
2. After tightening the clamp bolt, check the timing once again.

## Checking the timing advancer action

### ① CENTRIFUGAL ADVANCE:

Hook up the timing light. Disconnect the vacuum pipe to cut out the vacuum advancer. Start up the engine and pick up speed gradually to see if the ignition advances with rising speed in the manner represented by the curve in Fig. 9-5; if not, the cause is most likely a malcondition in the centrifugal advancer, due to broken or weakened governor-weight return springs or bound or sticky weights.

### NOTE:

When reading the ignition timing by referring to the Fig. 9-5, add 10 degrees (Static ignition timing) to the value represented by the graph.

### ② VACUUM ADVANCE:

Reconnect the vacuum pipe, and, as in ①, observe the flywheel timing mark under the timing light, with the engine running in no-load condition.

- a. Read the timing in terms of crank angle when the engine is running at 3,500 rpm.
- b. With the engine running at that speed, pull the vacuum pipe off the carburetor body and read the timing again. The difference between the first reading and the second reading is the angle of advance due to vacuum advancing.

### NOTE:

If the first reading is nearly equal to the second reading, vacuum advance is malfunctioning.

### CAUTION:

Before checking vacuum advance, be sure to inspect the vacuum pipe for pinhole, crack or break.

## 9-6. Replacement of Distributor Drive Gear

Replacing a worn-down driven gear (a part of the distributor assembly) is not enough. Inspect the drive gear, too, and replace it if it is badly worn down. The drive gear can be removed from the camshaft.

Worn gears in the distributor drive are likely to disturb the ignition timing and must be replaced.

When pressing the replacement drive gear onto camshaft, be sure to position the gear angularly as shown in Fig. 9-25. Note that the tooth root is radially centered on the center line through the keyway provided in camshaft.

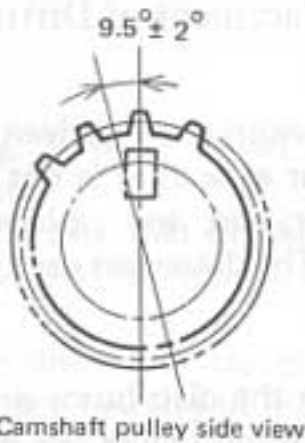
### NOTES:

1. Before removing the drive gear from the camshaft, scribe a match mark on this shaft and, when mounting the replacement drive gear, refer to this mark.
2. There is no need to discriminate between the two end faces of the drive gear: the gear may be fitted with either end held foremost.

**CAUTION:**

**Distributor gear case**

Where the distributor gear case has been removed in engine disassembly or at any other occasion, be sure to fill up the case with 60 cc (2.03/2.11 US/Imp oz) of engine oil after re-installing the case. Never start up the engine with the gear case empty of oil.



**Fig. 9-25**

**NOTE:**

Before removing the distributor gear case, disconnect the battery and drain the cooling system. Remove the timing belt and mark the crankshaft and camshaft positions. Remove the distributor gear case and inspect the distributor gear and the distributor gear case for wear and damage. Replace the distributor gear and the distributor gear case if necessary. Reinstall the distributor gear case and the timing belt. Reconnect the battery and refill the cooling system.

**NOTE:**

When reading the ignition timing by using the vacuum advance, the vacuum advance valve must be connected to the vacuum source. The vacuum source must be connected to the vacuum advance valve. The vacuum advance valve must be connected to the vacuum source. The vacuum advance valve must be connected to the vacuum source.

**3. VACUUM ADVANCE**

Disconnect the vacuum advance, and as in (1), observe the physical timing mark under the timing belt with the engine running in no-load condition.

a. Read the timing mark with the engine running. When the engine is running, the timing mark will be visible. b. With the engine running, read the timing mark. The vacuum advance valve must be connected to the vacuum source. The vacuum advance valve must be connected to the vacuum source. The vacuum advance valve must be connected to the vacuum source.

## 10-1. Description

A shift-lever type starter motor is used for cranking the engine. The motor is mounted on the cylinder block, with its drive pinion meshed with the ring gear of the flywheel. In the following illustration, note that the whole motor assembly inclusive of the magnetic switch and lever mechanism is enclosed.

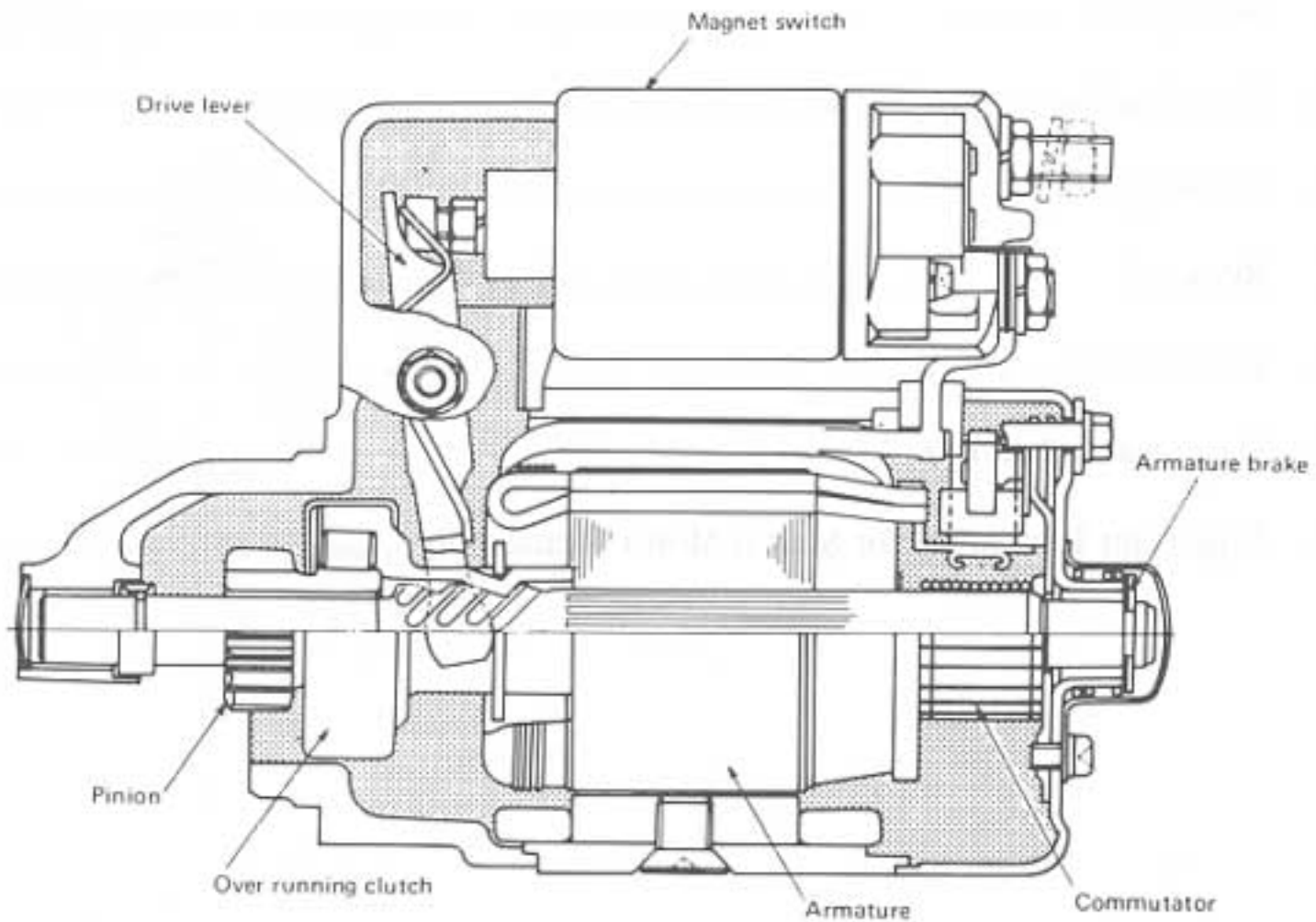


Fig. 10-1

## 10-2. Specifications

Voltage	12 volts
Output	0.6 kW
Rating	30 seconds
Direction of rotation	Counterclockwise as viewed from pinion side
Brush length	19 mm (0.75 in.)
Number of pinion teeth	9
No-load characteristic	55 A maximum at 11 volts, 3,500 rpm minimum
Load characteristic	230 A maximum at 9.5 volts and 0.5 kg-m torque, 2,000 rpm minimum
Locked rotor current	450A maximum at 8.5 volts, 1.1 kg-m minimum
Magnetic switch operating voltage	8 volts maximum

### 10-3. Cranking Action

#### Starting up the motor

Turning on the starting switch results in a small current flowing through the holding coil and another through the pull-in coil, both in the magnetic switch. The former current flows direct into ground, but the latter flows through motor armature and field. In other words, motor begins to run. In the magnetic switch, the two coils energized—pull-in coil and holding coil—develop a combined magnetic pull, by which the moving core is pulled against the force of the spring and moves toward the right (in the illustration). At this time, the motor armature is running but slowly because of the small initial current. As the moving core is forced toward the right, its left end turns the shift lever around its pivot, so that the bottom end of the lever pushes the clutch toward the left. Since the clutch is splined to the motor shaft and because the motor shaft is rotating, the clutch advances toward the left as assisted by the helical splines.

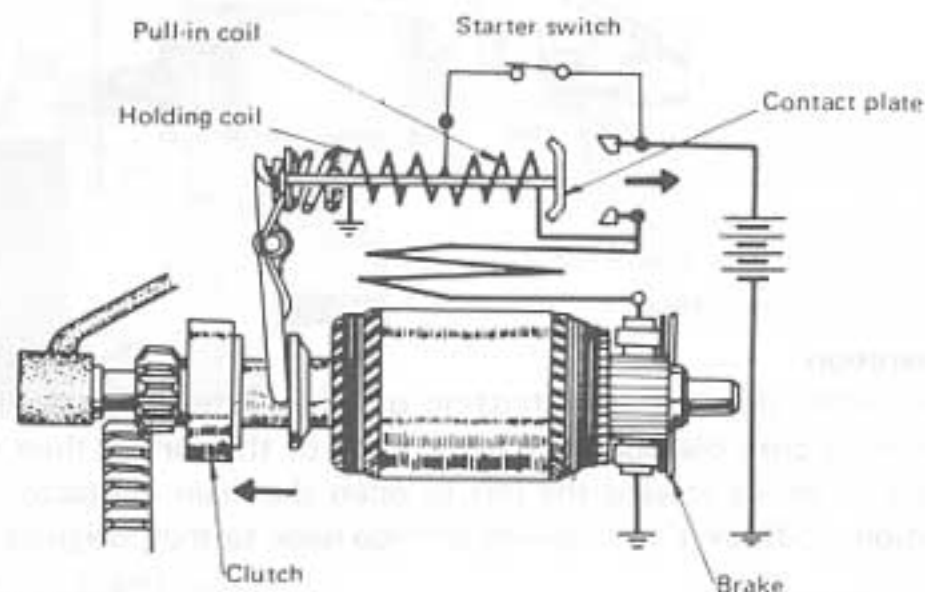


Fig. 10-2

#### Pinion meshing with the ring gear

The pinion may mesh into the ring gear smoothly or may bounce on the ring gear, depending on the relative positions of their teeth. In the latter event, the springs mounted on the clutch absorb the shock and, since the pinion is rotating and being pushed, its teeth will eventually mesh into those of the ring gear. In either case, the shift lever is allowed to turn fully and permit the moving core to be kept pulled all the way toward the right. When this happens, the main contactor of the magnetic switch closes to connect the starter motor direct to the battery. Consequently, a very large current—load current—flows through the motor to develop a high cranking torque for driving the engine crankshaft through the drive pinion and ring gear.

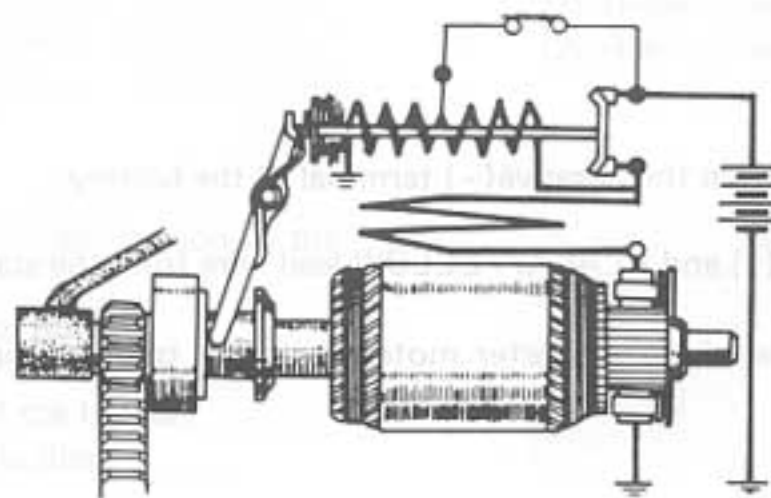


Fig. 10-3



### Engine cranking

When the motor is cranking the engine with full force, the pull-in coil is bypassed or shunted but the holding coil remains energized to hold the moving core in its shifted position. Under this condition, the shift lever is pushing the pinion by overcoming the force of springs.

As the engine fires up and begins to run steadily and if the starting switch is kept closed, the ring gear starts driving the pinion. When this occurs, the pinion merely spins on the motor shaft without transmitting this reverse drive to the motor. This is because the clutch is of overrunning type.

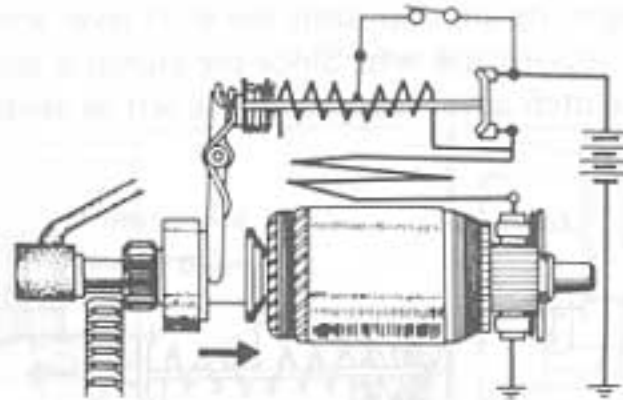


Fig. 10-4

### Terminating cranking operation

Turning off the starting switch de-energizes (shutting off the current) the holding coil so that the pull hitherto acting on the moving core disappears. By the force of the spring, then, the shift lever is turned back and the moving core is forced toward the left to open the main contactor. This shuts off the load current, and the drive pinion, shift lever and moving core go back to their original positions.

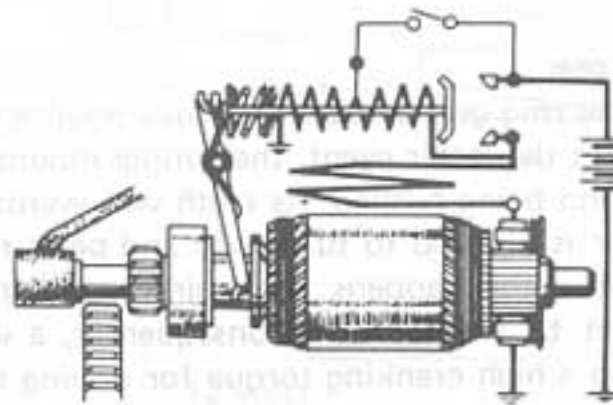


Fig. 10-5

## 10-4. Removal

- 1) Disconnect battery cable from the negative(-) terminal of the battery.
- 2) Disconnect the plus cord (+) and BLACK/YELLOW lead wire from the starter motor.
- 3) Remove the two bolts securing the starter motor assembly to the cylinder block, and take off the starter motor.

## 10-5. Disassembly

- 1) Remove the nut securing the end of the field coil lead to the terminal on the head of magnetic switch.
- 2) Take off the magnetic switch ① from the starter motor body by removing the two mounting screws.

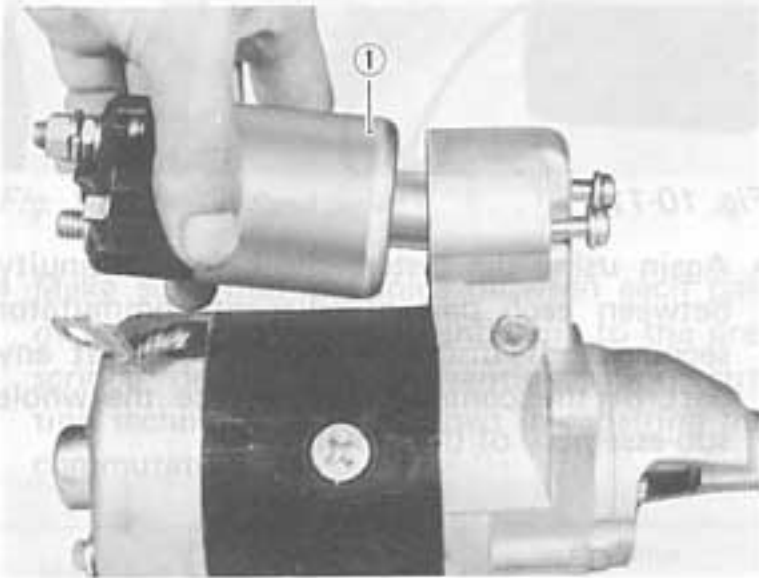


Fig. 10-6

- 3) Remove the bearing cover ②, and take out lock plate brake spring ③ and rubber ④.

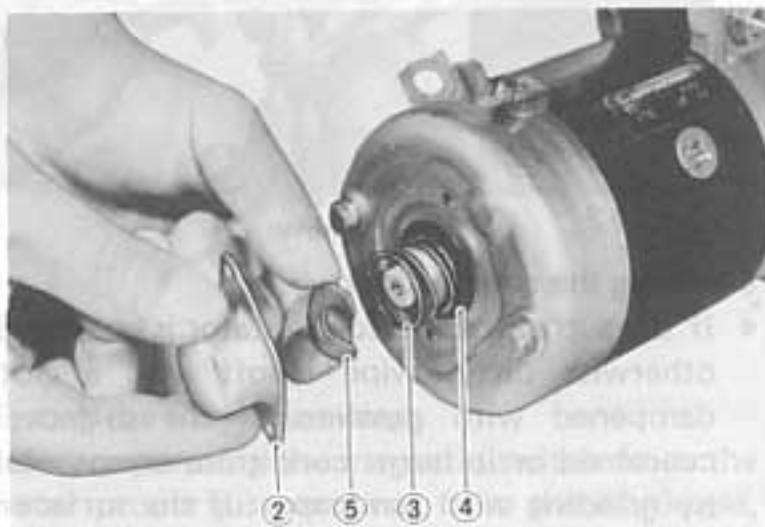


Fig. 10-7 ⑤ Clip

- 4) Disassemble the brush holder section in the following sequence:
  - (1) Remove two through bolts.
  - (2) Detach commutator end frame.
  - (3) Draw brushes out of the holder.
  - (4) Take out the brush holder.

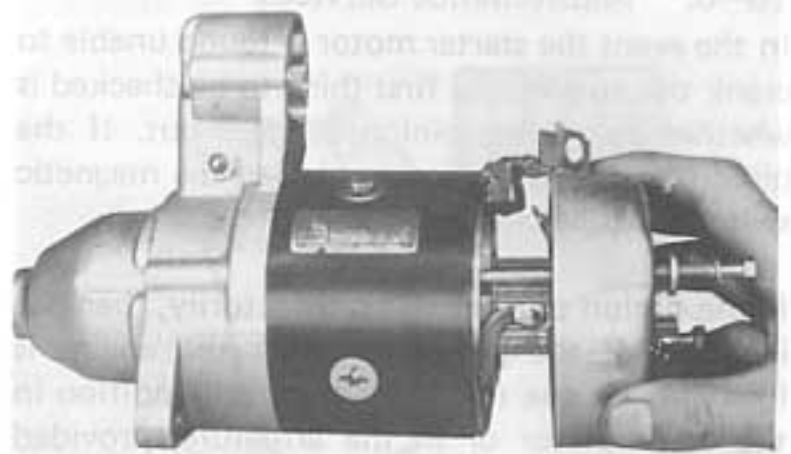


Fig. 10-8

- 5) Remove the case complete with field coils.
- 6) Pull off the set pin from shift lever, and take out the rubber and plate inside the housing.
- 7) From the housing, take out the armature, starter clutch and shift lever.



Fig. 10-9

- 8) Draw off the starter clutch, as follows:
  - (1) Draw stop nut toward the clutch side.
  - (2) Remove snap ring and slide off clutch.

## 10-6. Maintenance Services

In the event the starter motor is found unable to crank the engine, the first thing to be checked is whether the drive pinion plunges out. If the pinion does not plunge out, then the magnetic switch must be checked.

If the pinion plunges out satisfactorily, then the inability of the motor to crank the engine is likely to be due to some defective condition in the commutator or in the armature, provided that the battery is in good condition and that the circuit for applying the battery voltage to the motor is free from any open or fault. Having narrowed the scope of search for the cause of trouble to the motor proper, proceed as follows:

### Checking the field coils

Check to be sure that the field circuit is neither grounded or open-circuited. This can be effected by using a circuit tester as shown. If continuity is indicated by the tester hooked to the housing or frame, it means that the insulation has failed, resulting in a grounded field coil. Such a fault can be corrected by repair in most cases.



Fig. 10-10

### Checking the armature

- Using the circuit tester, see if there is any continuity between commutator and armature core. The tester will indicate infinite resistance if the insulation is in sound condition.



Fig. 10-11

- Again using the tester, check for continuity between each pair of adjacent commutator segments. If discontinuity is noted at any part of the commutator, replace the whole sub-assembly of the armature.

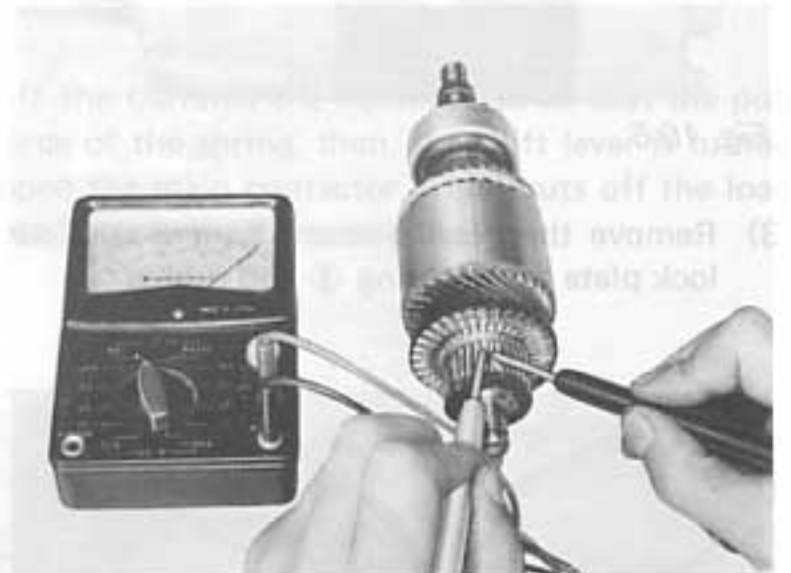


Fig. 10-12

### Servicing the commutator

- If the surface of the commutator is gummy or otherwise dirty, wipe it off with a cloth dampened with gasoline. If the surface is coarsened or in burnt condition, smoothen it by grinding with sandpaper. If the surface is grooved deep, it may be necessary to remove the groove marks by turning the commutator in a lathe; such turning is often successful in reconditioning the commutator if the extra stock necessary for removal by cutting is available without reducing its diameter to the limit.

Commutator diameter	Standard
	32.5 mm (1.28 in.)



Fig. 10-13 ① Sand paper

- Make sure that the mica between each pair of adjacent segments is undercut to the prescribed depth. The conventional undercutting technique is to be used in repairing the commutator.

Mica undercut	Standard	Service limit
	0.5 ~ 0.8 mm (0.02 ~ 0.03 in.)	0.2 mm (0.007 in.)

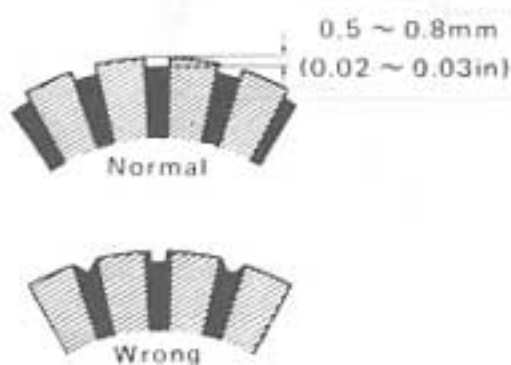


Fig. 10-14

#### Testing the magnetic switch

Before separating the magnetic switch from the motor proper just removed from the crankcase, test the switch by connecting the battery to the switch, as shown, to see if the drive pinion jumps out when the battery voltage is applied. (With the positive terminal of the battery cable end.) With the switch coils in sound condition, the drive pinion will jump out and, even when the main circuit is opened at "A", will remain in "jumped out" position. If undoing the connection at "A" causes the drive pinion to retract, it means that the holding coil is defective.

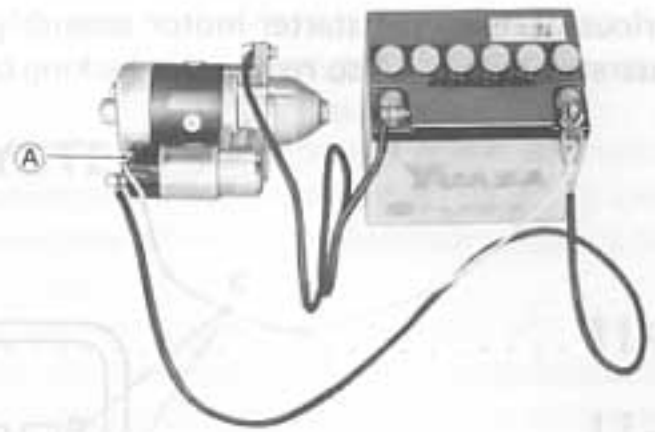


Fig. 10-15

#### Servicing the brushes

Check the length of each brush. If brushes are worn down to the service limit, replace them.

Brush length	Standard	Service limit
	19 mm (0.75 in.)	12 mm (0.47 in.)

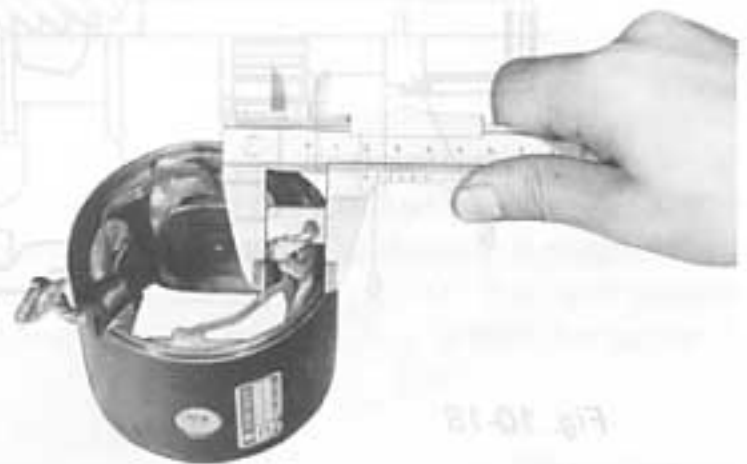


Fig. 10-16

#### Servicing the brush holders

Make sure that the insulation between the two brush holders, positive and negative, is in good condition. This should be verified with the use of the circuit tester. If any continuity is noted, repair the insulation.



Fig. 10-17



## 10-7. Important Reminders for Starter Motor Reassembly

Various parts of the starter motor assembly need lubrication at each overhaul. The lubrication points are illustrated below: (Also required is locking by punching.)

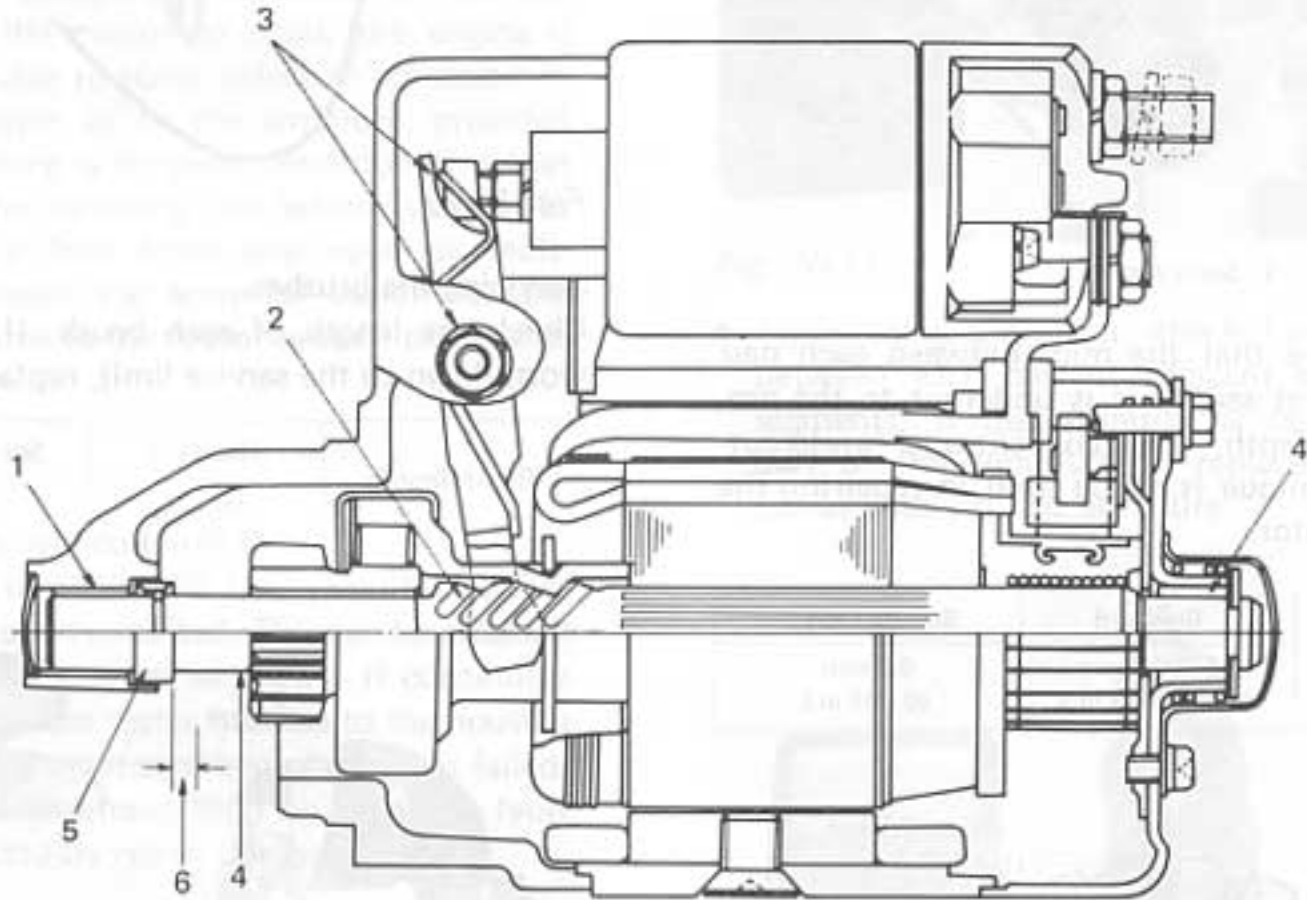


Fig. 10-18

- 1) Give grease to the bush in the drive housing.
- 2) Grease the helical splines before mounting the clutch sub-assembly.
- 3) Grease the sliding or contacting surfaces associated with shift lever.
- 4) Grease the bush fitted into the end frame and also the armature shaft end inserted into this bush.
- 5) After installing the stop nut, lock it by staking at two places with a punch.
- 6) Adjust the length of the moving stud so that the clearance between the stop nut and the pinion in plunged-out condition will be from 1 to 4 mm (0.04 to 0.16 in.). To check, run the motor in no-load condition to plunge out the pinion and wait till the motor speed settles.

## 11-1. Description

The charging system consists of the alternator complete with a means of rectification for producing DC output power, and the two-element regulator unit for controlling the voltage.

In the alternator, the armature is stationary; it consists of three coils mounted on the stator in such a way as to produce three-phase alternating voltage. This voltage applies to the rectifier for full-wave rectification. The rectifier delivers power in the form of direct current.

Against the stationary armature, revolving magnetic fields are produced by the field winding carried in the rotor. This feature of construction of the alternator strikes a distinct contrast to the dynamo (DC generator), in which the field is in the stator while the armature is in the rotor.

The magnitude of three-phase AC power available from the alternator to its rectifier is directly proportional to rotor speed and field (excitation) current. It is the function of the regulator unit to control the field current automatically in such a way that the output voltage remains constant; another function is to control the circuit of the charge warning lamp. Thus, the regulator unit has two elements; one is voltage regulator for performing the first function and the other is voltage relay for the second function.

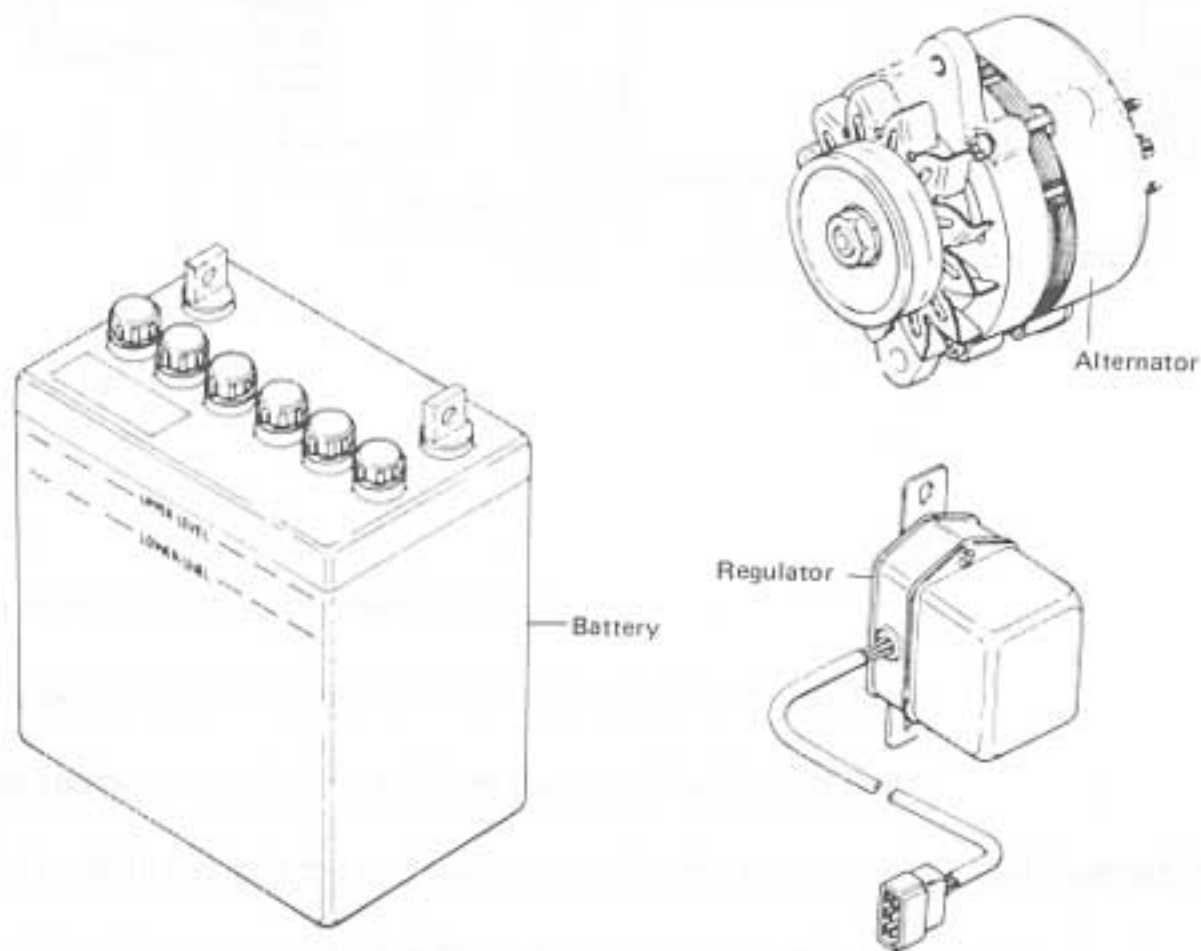


Fig. 11-1

## 11-2. Charging Operation

The following description of the system operation is referenced to the circuit diagram indicated in Fig. 11-2. Closing the ignition switch connects the charge warning lamp to the battery; a small current flows through the lamp, lighting this lamp to signify that the alternator is not charging the battery, and through the contact point of voltage relay to ground. Another current flows from the battery through the contact point of voltage regulator into the field winding in the alternator rotor, thereby producing magnetic fields around the rotor. These fields, which are stationary at this time because the rotor is not running, link the armature coils and the rotor poles through the air gap between stator and rotor.

Under these conditions, suppose the engine is started up. The rotor begins to run, and its magnetic fields revolve to "cut" the three armature coils in succession. In each armature coil, an electromotive force is generated by electromagnetic induction. This force changes its direction alternately. Consequently, the three armature coils apply three alternating voltages to the rectifier. Viewed collectively, these voltages constitute the three-phase output voltage of the alternator.

The rectifier consists of three pairs of rectifying diodes, forming three one-way paths of current for full-wave rectification to convert the alternator output power into a direct current power, which is available from the "B" terminal of the alternator-rectifier unit, relative to "E" (ground) terminal.

As the engine picks up speed, the electromotive force induced in each armature coil increases, so that the output voltage appearing at terminal "B" (relative to terminal "E") becomes high enough to "push" electricity into the battery through its positive terminal. In other words, the battery begins to draw a charging current.

Let's take a look at the pressure coil of the voltage relay. One end of this coil is connected to terminal "E" and the other end to the neutral point "N" of the three armature coils. Potential level of "E" (ground) is now so much lower than that of "N" that a current flows in the pressure coil to develop a magnetic pull on its armature carrying point "P5". Consequently, point "P5" separates from point "P4" and touches point "P6"; the charge warning lamp thus becomes shunted and stops burning to signify that the battery is getting charged.

During the early stage of engine starting, the alternator output voltage may be lower than the battery voltage; even in such a case, no current flows from the battery into the alternator because of the rectifier diodes. The reason why a cutout relay is not used here is explained by the presence of the diode rectifier.

The function of the voltage regulator with its voltage coil is to alter the path of field (excitation) current for the field coil, in order to maintain the alternator output voltage at a relatively constant level. When this voltage rises owing to a rise in engine speed, the voltage coil pulls point "P2" away from point "P1", thereby introducing the control resistor "R1" into the field circuit. Field current falls slightly because of this resistance and, consequently, the output voltage falls to the normal level. If the engine picks up speed further, the magnetic pull developed by the voltage coil increases to bring point "P2" into contact with "P3", thereby shunting the field coil to reduce the field current to zero. Under this condition, voltage generation in the alternator is dependent on the residual magnetization of the rotor, which is small enough to keep down the output voltage to the normal level.

The foregoing description of the voltage regulator operation may be summarized as follows: the regulator controls the alternator output voltage by controlling the field current in three steps; first allowing a full field current to flow; secondly, by inserting a resistor into the circuit to reduce the field current; and thirdly, by shunting the field coil to reduce the current to zero, all for maintaining the output voltage at a relatively constant level.



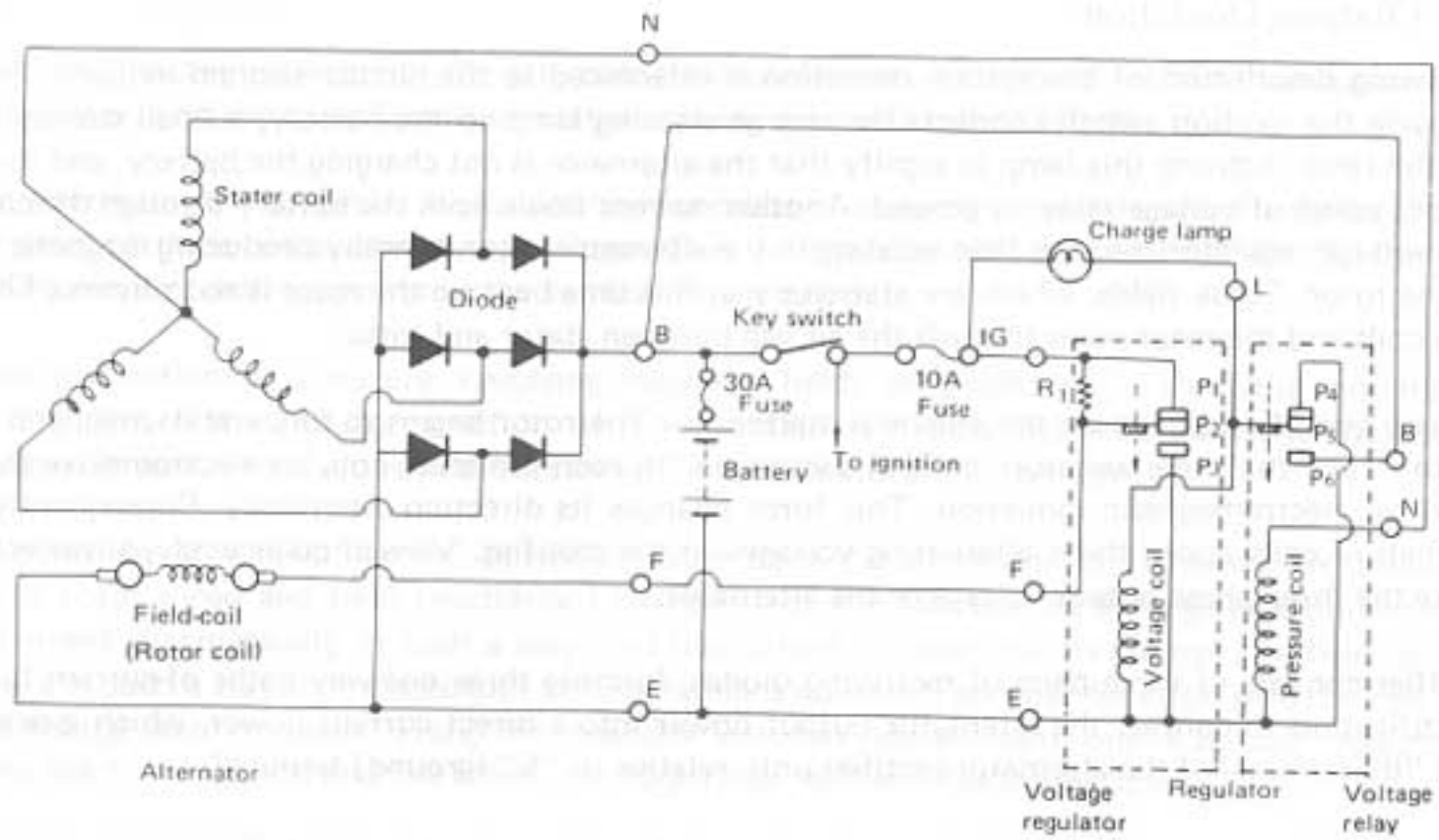


Fig. 11-2

The voltage regulator is a device which controls the output voltage of the alternator. It is connected to the positive terminal of the battery and the positive terminal of the alternator. The voltage regulator is connected to the positive terminal of the battery through a 30A fuse. The voltage regulator is connected to the positive terminal of the alternator through a 10A fuse. The voltage regulator is connected to the positive terminal of the battery through a 30A fuse. The voltage regulator is connected to the positive terminal of the alternator through a 10A fuse. The voltage regulator is connected to the positive terminal of the battery through a 30A fuse. The voltage regulator is connected to the positive terminal of the alternator through a 10A fuse.

During the early stage of engine starting, the alternator output voltage is low. The voltage regulator is connected to the positive terminal of the battery through a 30A fuse. The voltage regulator is connected to the positive terminal of the alternator through a 10A fuse. The voltage regulator is connected to the positive terminal of the battery through a 30A fuse. The voltage regulator is connected to the positive terminal of the alternator through a 10A fuse.

The junction of the voltage regulator with the voltage coil is to alter the current in the field coil. The voltage regulator is connected to the positive terminal of the battery through a 30A fuse. The voltage regulator is connected to the positive terminal of the alternator through a 10A fuse. The voltage regulator is connected to the positive terminal of the battery through a 30A fuse. The voltage regulator is connected to the positive terminal of the alternator through a 10A fuse. The voltage regulator is connected to the positive terminal of the battery through a 30A fuse. The voltage regulator is connected to the positive terminal of the alternator through a 10A fuse.

The following description of the voltage regulator condition may be summarized as follows: The voltage regulator is connected to the positive terminal of the battery through a 30A fuse. The voltage regulator is connected to the positive terminal of the alternator through a 10A fuse. The voltage regulator is connected to the positive terminal of the battery through a 30A fuse. The voltage regulator is connected to the positive terminal of the alternator through a 10A fuse.

### 11-3. Alternator

#### Description

In order to distinguish it from conventional automotive dynamos, the AC generating device is called an alternator for it produces a DC output from three alternating currents generated in its winding.

The alternator consists of: the rotor (which produces revolving magnetic fields), stator (which is a series of coils disposed and arranged to form three coil groups), two slip rings and two brushes (through which DC excitation current is fed into the field winding of the rotor), and the rectifier (which consists of 6 semiconductor diodes, and is built in the alternator).

In operation, the revolving magnetic fields "cut" the stator coils. In other words, the three groups of coils experience changes in magnetic flux. By the flux changes, an alternating electromotive force (emf) is induced in each coil group. Thus, three alternating voltages are available from the stator.

The six diodes are arranged so that they "rectify" or convert the three alternating outputs into a DC output. Three-phase full-wave rectification is effected by the built-in rectifier.

In terms of electric current, a diode is a circuit element that passes the current only in one direction. Of the six diodes, three are arranged to pass currents in the same direction, and the remaining three in the opposite direction. Since three alternating currents undergo full-wave rectification and are combined into one by superposition, the DC output of this alternator is much steadier and carries much less pulsating or ripple components than a DC output made available by full-wave rectification of a single-phase alternating current.

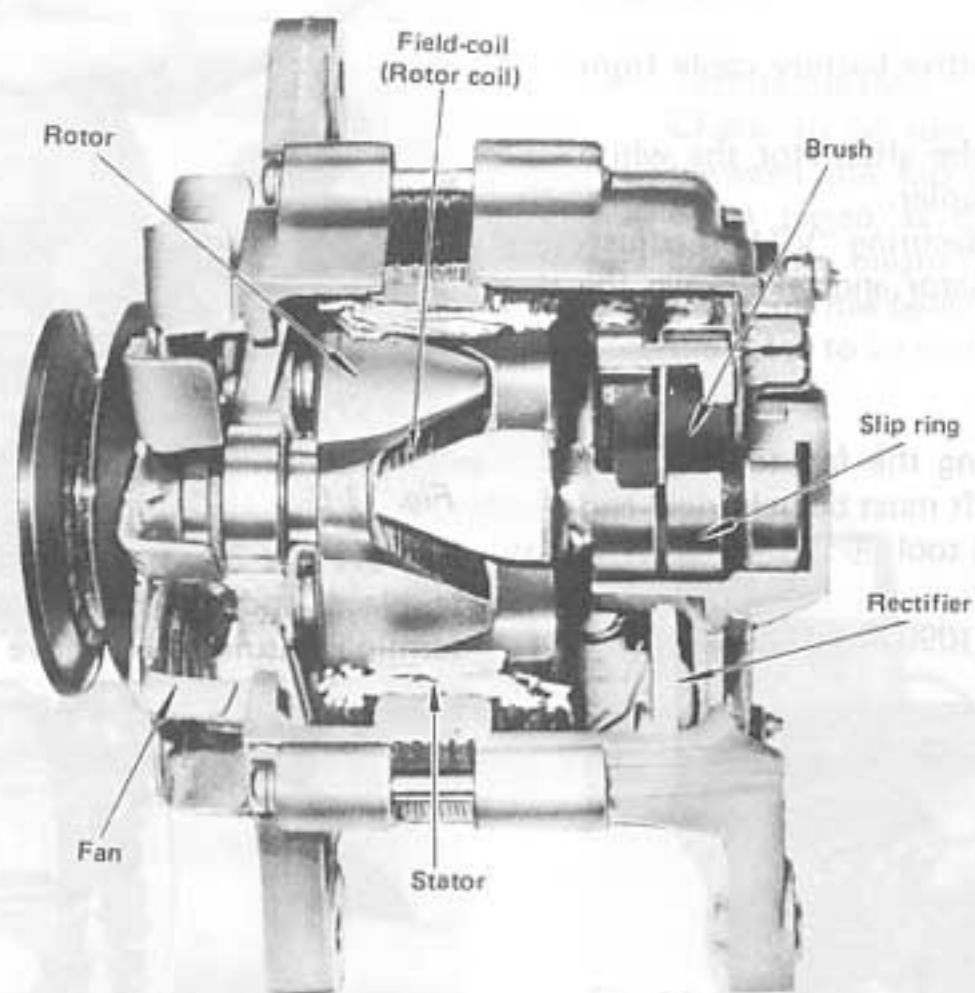


Fig. 11-3

## Data and Specification

Nominal operating voltage	12 Volts
Maximum alternator output (14V)	35A
Polarity	Negative ground
Effective pulley diameter	65 mm (2.56 in.)
No-load alternator speed	1,050 – 1,250 r/min 14 Volts at normal temperature
Full-load alternator speed	4,000 r/min maximum, 35A, 14 Volts at normal temperature
Direction of rotation	Clockwise as viewed from pulley side
Maximum permissible alternator speed	13,000 r/min
Working temperature range	-40°C ~ 80°C (-104°F ~ 176°F)
Rectification	Full-wave rectification

### Removal

- (1) Disconnect the positive battery cable from the battery.
- (2) Disconnect from the alternator the white cord and circuit coupler.
- (3) Remove the bolts securing "V" belt adjusting arm and alternator and take down the alternator.

### Alternator Disassembly

Remove the nut securing the fan to the rotor shaft. To do so, the shaft must be held rigid and steady by using a special tool **(A)**.

Hexagon wrench, 6 mm (09911-70120)

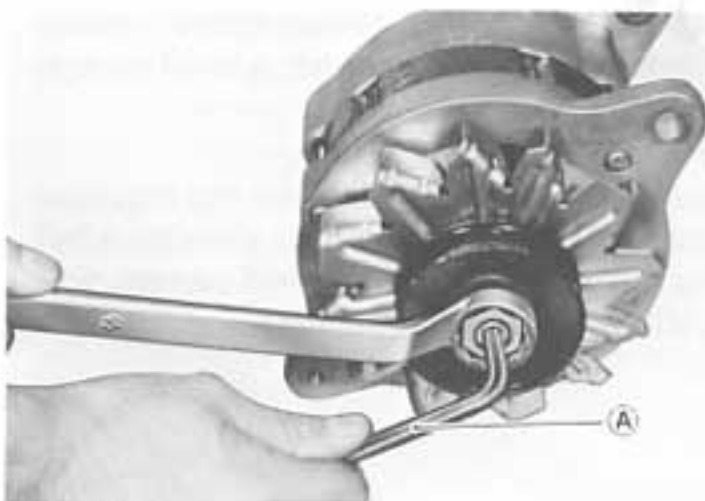


Fig. 11-4

Remove the 3 bolts fastening the end frame to the rotor housing; tap on the edges of the end frame with a wooden mallet to separate it from the housing, thereby severing the rotor from the stator.

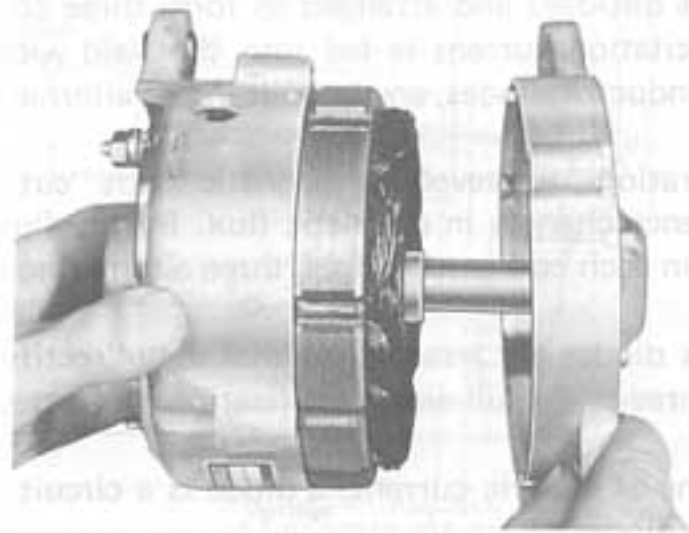


Fig. 11-5

Draw out the rotor. It may be necessary to lightly tap on the core and housing.



Fig. 11-6

Remove the 3 nuts securing the rectifier holder in place, and one other nut holding down the terminal insulator. Remove the rear end cover.

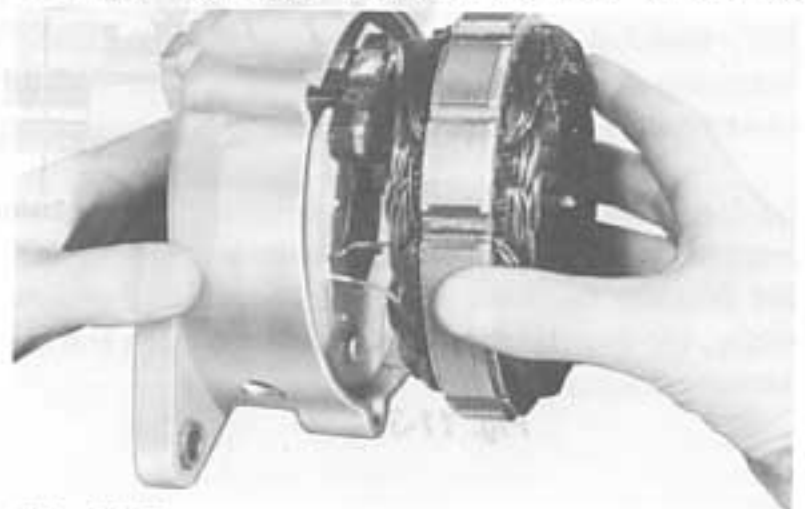


Fig. 11-7

Remove the brush holder from the stator.

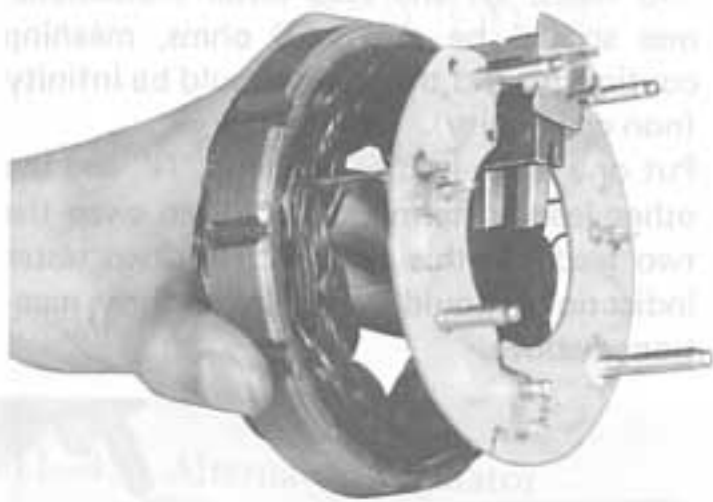


Fig. 11-8

**NOTE:**

The alternator is to be reassembled by reversing the foregoing sequence of steps. Before inserting the rotor into the housing, be sure to have the brushes installed in the holder. (Use a proper size rod **A**, manipulating it from the rectifier side, to set the brush in the holder.)

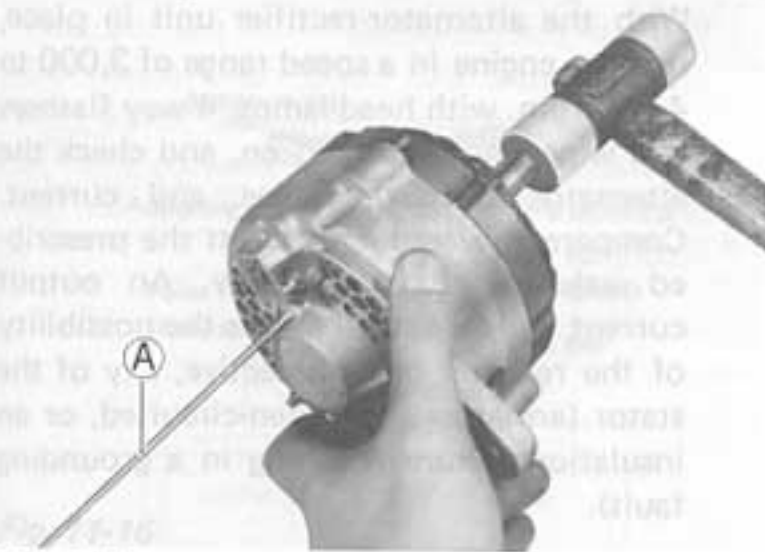


Fig. 11-9

**Maintenance Services**

(1) Rotor

- Testing the rotor for open-circuit  
Check to be sure there is continuity between the two slip rings when tested as shown. Absence of continuity means that the field coil is open-circuited and must be replaced.

Ring-to ring circuit resistance	4 – 5 ohms
---------------------------------	------------



Fig. 11-10

- Testing the rotor for grounding  
Check to be sure there is no continuity between the slip ring and the rotor shaft when tested as shown. Presence of any continuity means that the insulation on the field coil has failed, making it necessary for the rotor to be replaced.



Fig. 11-11



(2) Stator

Check to be sure there is no continuity between the stator core and each armature coil; any continuity noted means that the coil is grounded. A grounded armature coil can be corrected by locating the faulted point and repairing the fault.



Fig. 11-12

(3) Brushes

Check each brush for wear by measuring its length, as shown. If the brush is found worn down to the service limit, replace the brush and holder altogether.

Brush length	Standard	Service limit
	16.5 mm (0.65 in.)	11.0 mm (0.45 in.)

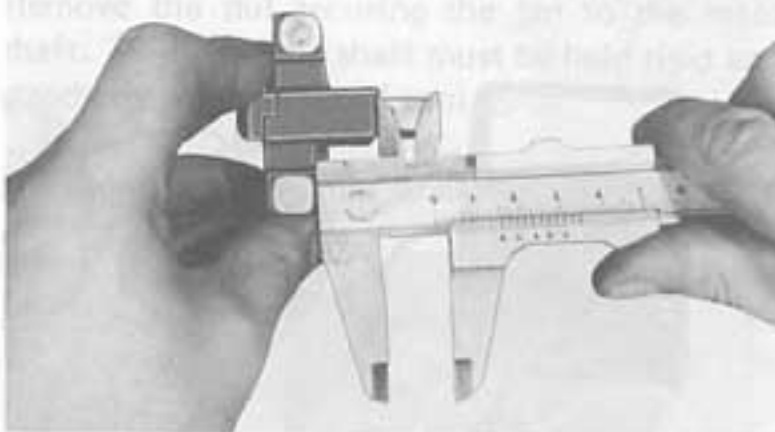


Fig. 11-13

(4) Rectifier

The rectifier is to be checked with the circuit tester for continuity in one direction and non-continuity in the other direction.

Put one tester lead to terminal "B" and the other lead to terminal "N"; then swap the two leads. Of the two tester indications, one should be about 20 ohms, meaning continuity, and the other should be infinity (non continuity).

Put one tester lead to terminal "N" and the other lead to terminal "E"; then swap the two leads. In this case, too, the two tester indications should be similar to those mentioned above.



Fig. 11-14

(5) Alternator load performance

With the alternator-rectifier unit in place, run the engine in a speed range of 3,000 to 4,000 rpm, with head lamps, 4-way flashers and wiper motor turned on, and check the alternator output voltage and current. Compare the readings against the prescribed values, indicated below. An output current which is small means the possibility of the rectifier being defective, any of the stator (armature, coil open-circuited, or an insulation failure resulting in a grounding fault).

Standard output voltage and current	13.8 ~ 14.8 volts, 20A minimum
-------------------------------------	-----------------------------------

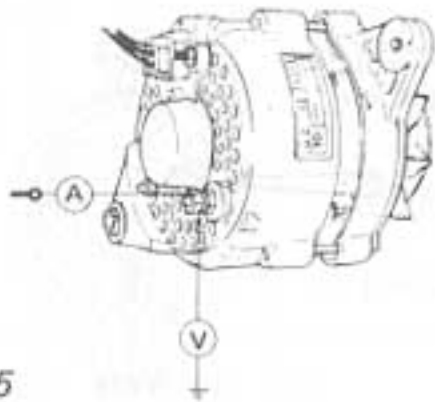


Fig. 11-15

### 11-4. Alternator Regulator

In the two-element regulator, one coil acts as voltage limiter or regulator and the other coil as relay for controlling the charge warning lamp. It should be noted in the circuit diagram that the magnetic pull developed by the voltage coil to move its moving point "P2" is roughly proportional to the alternator output voltage, whereas the magnetic pull developed by the pressure coil of the relay is dependent on the potential level of neutral point "N" of the armature with respect to the ground. A clear understanding of these relations is essential in checking, testing and servicing the regulator unit.

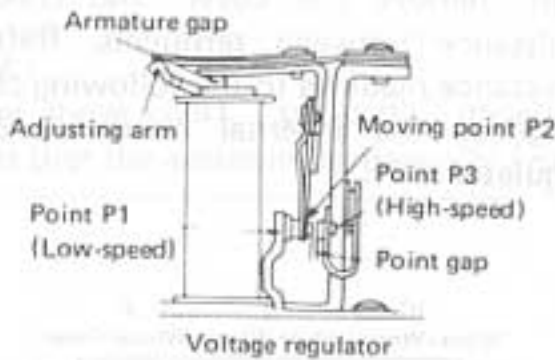


Fig. 11-16

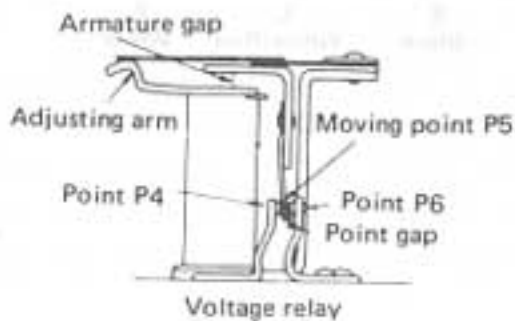


Fig. 11-17

### Specifications

Regulated voltage	13.8 ~ 14.8 volts
Voltage-relay cut in voltage	4 ~ 5.8 volts

### Maintenance services

- (1) Voltage-regulator limiting action test  
Hook up a voltmeter, inserting it between the alternator "B" terminal and ground, and run the engine within a range of 2,000 to 3,000 rpm, while reading the voltmeter indication. The voltage read is the charging voltage as limited by the action of the voltage regulator; the reading should be within the prescribed range, which is indicated below. If the charging voltage is found too high or too low, adjust it by bending the adjusting arm of the voltage regulator.

Prescribed range of charging voltage	13.8 ~ 14.8 volts for 2,000 ~ 3,000 engine rpm
--------------------------------------	--



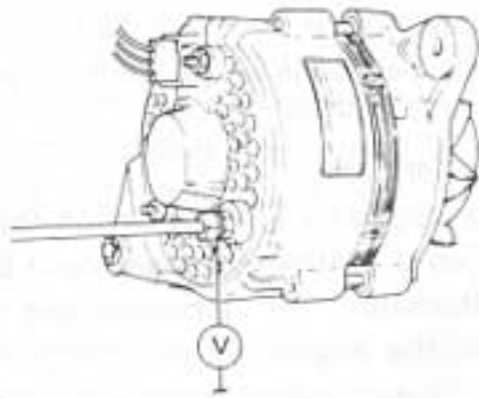


Fig. 11-18

- a) If the charging voltage is noted to oscillate or otherwise be unstable, it is most likely that the contact point faces in the voltage regulator are dirty or roughened. Cleaning and smoothening the faces will remedy this malcondition.
- b) If the charging voltage is too high, the possible causes are as follows:
  - Armature gap is too wide on low-speed side or high-speed side in the voltage regulator.
  - Contact resistance at high-speed side point is too large.
  - The coil of voltage regulator or relay is open-circuited.
  - Open circuit in the line to "N" or "B" terminal of the regulator unit. (Refer to Fig. 11-20 )
  - Contact pressure is too high on low-speed side point.
  - Imperfect grounding of the regulator unit.

(2) Continuity test on field coil

Using the circuit tester, check for continuity between the "E" and "F" terminals of the alternator, as shown. The tester should indicate continuity with a resistance value meeting the following specification:

Standard field circuit resistance	Several ohms
-----------------------------------	--------------

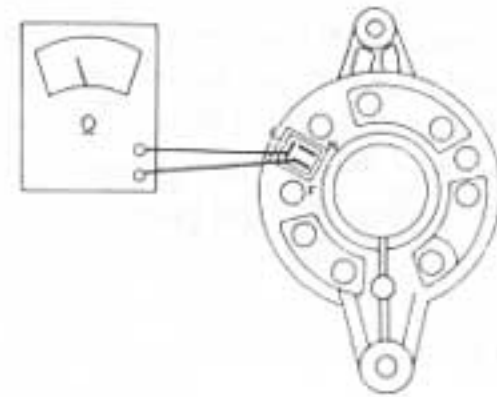


Fig. 11-19

- a) If the resistance value noted is too small, it is likely that there is a short-circuit through insulation layers in the coil.
  - b) If the resistance value noted is too large, the following possibilities must be considered:
    - An open-circuit is developing in the field coil.
    - The brushes are not seated properly on the slip rings.
    - Brushes or slip rings are burnt.
- (3) Checking terminal-to-terminal resistances  
 Pull off the connector from the regulator unit, remove the cover, and check the resistance between terminals. Refer the resistance readings to the following chart to diagnose the internal condition of the regulator unit:

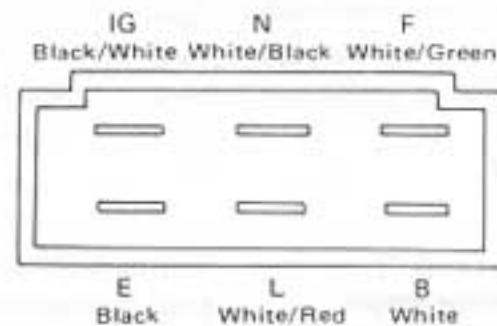


Fig. 11-20

Guide on regulator diagnosis				
Terminal checked	State of vol. relay	State of vol. regulator	Normal resistance value (ohms)	Diagnosis
IG-F		Standstill	Zero	If not zero, point contact is defective on low-speed side.
		Operated	Approx. 11	If infinity is noted, control resistor is open-circuited.
L-E	Standstill		Zero	If not zero, relay contact point is not closing fully.
	Operated		Approx. 100	If zero, relay point faces are fused together. If infinity is noted, voltage coil is open-circuited.
N-E			Approx. 24	If zero, pressure coil is shorted. If infinity, pressure coil is open-circuited.
B-E	Standstill		Infinity	If not infinity, relay point faces are fused together.
	Operated		Approx. 100	If zero, voltage coil is shorted. If infinity, voltage coil is open-circuited or contact action of the point is defective.
B-L	Standstill		Infinity	If not infinity, relay point faces are fused together.
	Operated		Zero	If not zero, contact action of the point is defective.

**NOTE:**

In the above chart, "standstill" means that the regulator unit is in de-energized state; "operated" means that the armature is manually (with a fingertip) actuated as if it were pulled in by the coil.

(4) Gap adjustment

① Voltage relay

Using a thickness gauge, check the two gaps, point gap and armature gap. Refer the gauge readings to the specification value, below, and adjust the gaps as necessary.

Gap specifications	
Armature gap	Approx. 0.6 mm (0.023 in.)
Point gap	Approx. 0.4 mm (0.015 in.)



Fig. 11-21

② Voltage regulator

Two gaps are to be checked: point gap, and armature gap. Use a thickness gauge, and compare the readings taken against the following specifications. Adjust the gaps as necessary.

Gap specifications	
Armature gap	Approx. 1.1 mm (0.043 in.)
Point gap	Approx. 0.5 mm (0.019 in.)



Fig. 11-22

## 11-5. Battery

### 1) Battery specifications

Model	12N24-3
Rated capacity	26AH, 12 Volts
Electrolyte	1.8 litres (3.8/3.2 US/Imp.Pt.)
Electrolyte S.G.	1.280 when fully charged at 20°C (68°F)

## 2) Care of the battery

The following information is basic in nature and is nothing new; it is merely a reiteration of what every Service shop personnel knows about the automotive storage battery. The information is intended to serve as a reminder to the reader, with a hope that he will, in turn, remind each final user of the important basic facts about the battery whenever opportunity permits him to engage in a conversation with the final user in the shop or out of the shop.

(1) The battery is a very reliable component, but needs periodical attentions.

Keep the battery container clean; prevent rust formation on the terminal posts; keep the electrolyte up to the upper level uniformly in all cells; and try to keep the battery fully charged at all times.

(2) Preserve the capacity of the battery.

There is a limit to the ability of the battery to hold electricity in store. This limit is called "capacity."

There are several ways for the battery to lower its capacity:

(a) Loss of electrolyte, or fall in electrolyte level.

When this happens, the battery cannot hold so much electricity as it originally could. Handle the battery with care when you take it down. Barring the loss of electrolyte by careless spilling or otherwise, the electrolyte level goes down gradually in the battery at work because the water content of it evaporates. Periodically refill distilled water to each cell, as necessary, so that the electrolyte is always up to the specified level. Never allow its surface to fall so much as to expose the cell plates.

(b) Overcharging the battery in place or off the machine.

In recharging the battery off the machine, caution must be exercised so as not to overcharge it. Overcharging gives rise to several complexities. For one thing, it heats up the battery to deform the battery container to result in a destroyed battery. Overcharging could occur in a battery in place if the voltage regulator is maladjusted to allow the alternator (or the dynamo in other machines) to develop too high an output voltage. For another thing, "gassing" occurs in a battery being overcharged to result in a loss of water content. One of the most serious consequences of overcharging is the swelling of positive-plate grids, causing the grids to crumble and the plates to buckle.

(c) Undercharging the battery in place.

Regulator malfunctioning is usually the cause of the battery remaining in a state of charge far below its capacity. This condition is very undesirable in freezing weather, for the electrolyte in such a battery can easily freeze up to result in a destroyed battery. Moreover, an undercharged battery is an easy prey to a greater evil-sulfation.

(d) Sulfation.

Let us recall the electrochemical reactions that take place in the battery during charging and discharging. As the battery gives out its energy (discharging), the active materials in its cell plates are converted into lead sulfate. During recharging, this lead sulfate is reconverted into active material. If the battery is allowed to stand for a long period in discharged condition, the lead sulfate becomes converted into a hard, crystalline substance, which will not easily turn back to the active material again during the subsequent recharging. "Sulfation" means the result as well as the process of that reaction. Such a battery can be revived by very slow charging and may be restored to usable condition but it is a damaged battery and its capacity is lower than before.



- (3) Keep the battery cable connections clean.

The cable connections, particularly at the positive (+) terminal post, tend to become corroded. The product of corrosion, or rust, on the mating faces of conductors resists the flow of current. The inability of the starter motor to crank the engine is often due to the rust formation in the battery cable connection. Clean the terminals and fittings periodically to ensure good metal-to-metal contact, and grease the connections after each cleaning to protect them against rusting.

- (4) Be always in the know as to the state of charge of the battery.

The simplest way to tell the state of charge is to carry out a hydrometer test. The hydrometer is an inexpensive instrument for measuring the specific gravity (S.G.) of the battery electrolyte. Why measure the S.G.? Because the S.G. of the electrolyte is indicative of the state of charge.

The direct method of checking the battery for state of charge is to carry out a high-discharge test, which involves a special low-reading voltmeter, an expensive instrument used generally in the service shops but no recommendable to the user of the machine.

At 20°C of battery temperature (electrolyte temperature):

The battery is in FULLY CHARGED STATE if the electrolyte S.G. is 1.280.

The battery is in HALF CHARGED STATE if the S.G. is 1.220.

The battery is in NEARLY DISCHARGED STATE if the S.G. is 1.150 and is in danger of freezing.

What if the battery temperatures not 20°C (68°F)? Since the S.G. varies with temperature, you have to correct your S.G. reading (taken with your hydrometer) to the value at 20°C, and apply the corrected S.G. value to the three-point guide stated above. This manner of correction needs a chart showing the relation between S.G. and temperature. There is a simpler way: refer to the graph given below, which tells you the state of charge for a range of S.G. value and a range of temperature.

How to use the temperature-corrected state-of-charge graph.

Suppose your S.G. reading is 1.28 and the battery temperature is -5°C (23°F). Locate the intersection of the -5°C line and the 1.28 S.G. line. The intersection is "A". It is in the zone for CHARGED STATE. How much is the battery charged? To find out the answer, draw a line parallel to the zone demarcation line, extending it to the right, and see where this line crosses the percentage scale. In the present example, the line crosses at, say, 85% point. The battery is 85% fully charged.

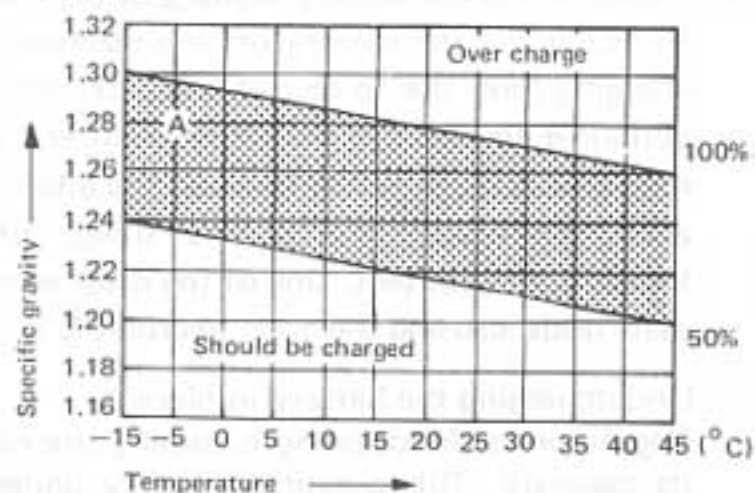


Fig. 11-23

## 12-1. Description

The clutch is a diaphragm-spring clutch of a dry single disc type, as shown in the cross-sectional view of Fig. 12-1. The diaphragm spring is of a tapering-finger type, which is a solid ring in the outer diameter part, with a series of tapering fingers pointing inward. The disc, carrying six torsional coil springs, is slidably mounted on the transmission input shaft with a serration fit.

The clutch cover is secured to the flywheel, and carries the diaphragm spring in such a way that the peripheral edge part of the spring pushes on the pressure plate against the flywheel (with the disc in between). When the clutch release bearing (throwout bearing) is held back: This is the engaged condition of the clutch.

Depressing the clutch pedal causes the release bearing to advance and push on the tips of the tapering fingers of the diaphragm spring. When this happens, the diaphragm spring acts like the release levers of a conventional clutch, pulling the pressure plate away from the flywheel, thereby interrupting the flow of drive from flywheel through clutch disc to transmission input shaft.

The clutch construction is simple, well balanced relative to rotating speed, durable and capable of withstanding high torsional load and, what is particularly noteworthy, does not require adjustment of the kind involved in the conventional coil-pressure-spring release-lever type of clutch.

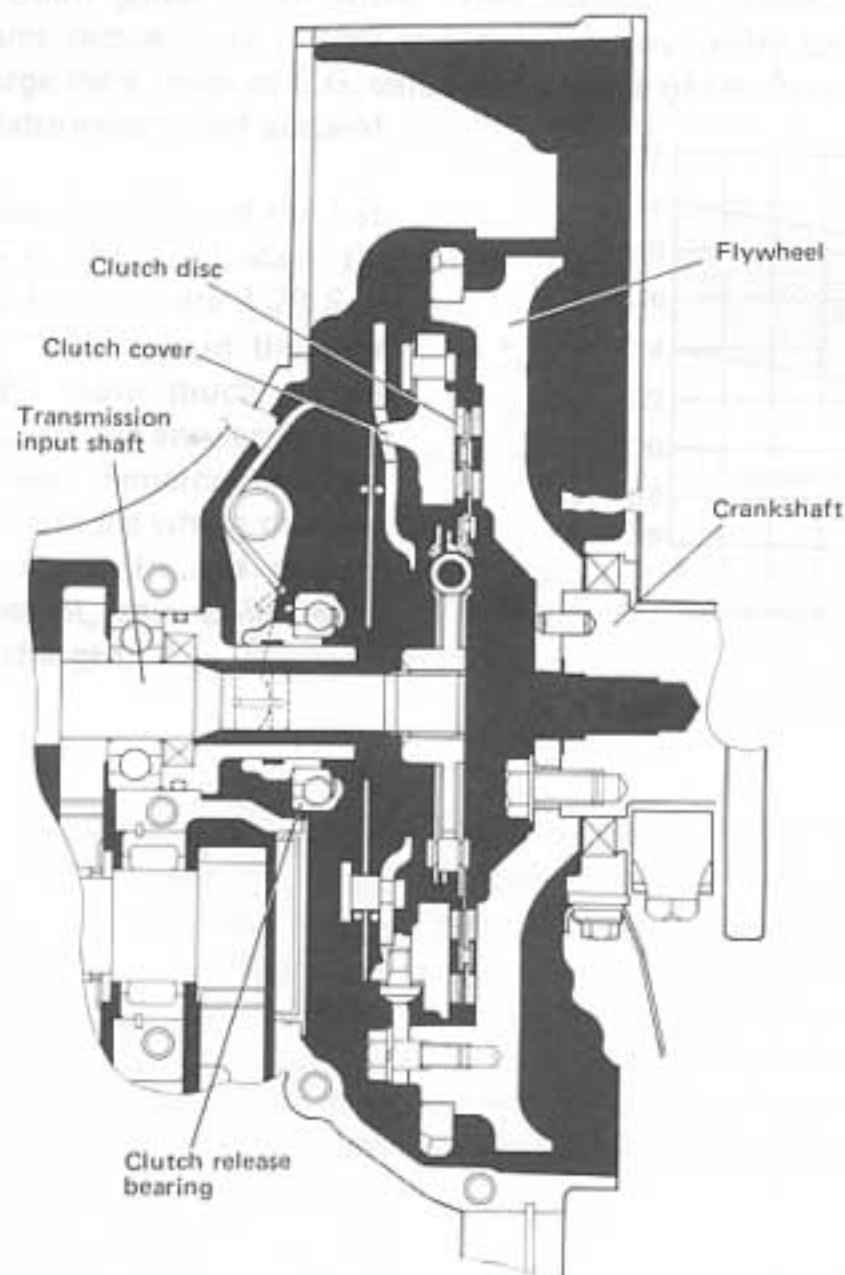


Fig. 12-1



## 12-2. Removal

Removal of the clutch presupposes that the transmission has been dismantled according to the method outlined in the section for the transmission.

Remove the 6 bolts securing the clutch cover to the flywheel, and take off the cover and clutch disc. Special tool A (Flywheel stopper 09916-97820)

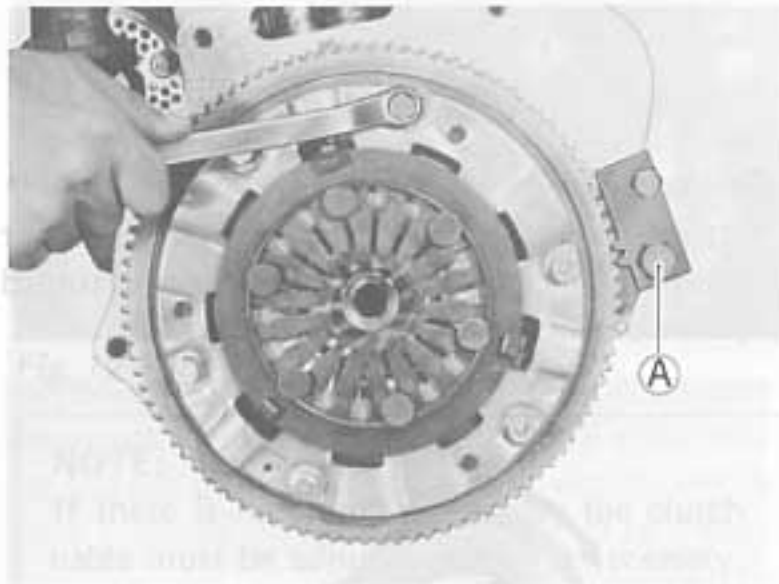


Fig. 12-2

With the clutch release bearing attached to the retainer, remove the retainer spring from the release shaft. The release bearing will come off as the spring is being removed.

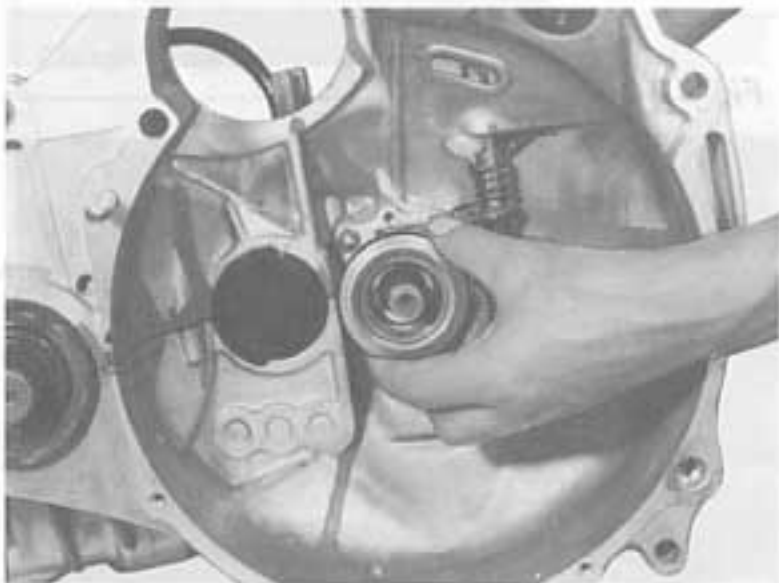


Fig. 12-3

## 12-3. Maintenance Services

### Clutch disc facing surface condition

A burnt or glazed (glass-like surface) facing can be reconditioned by grinding it with No.120~200 sandpaper. If the surface is in a condition beyond repair, replace the whole clutch disc assembly.

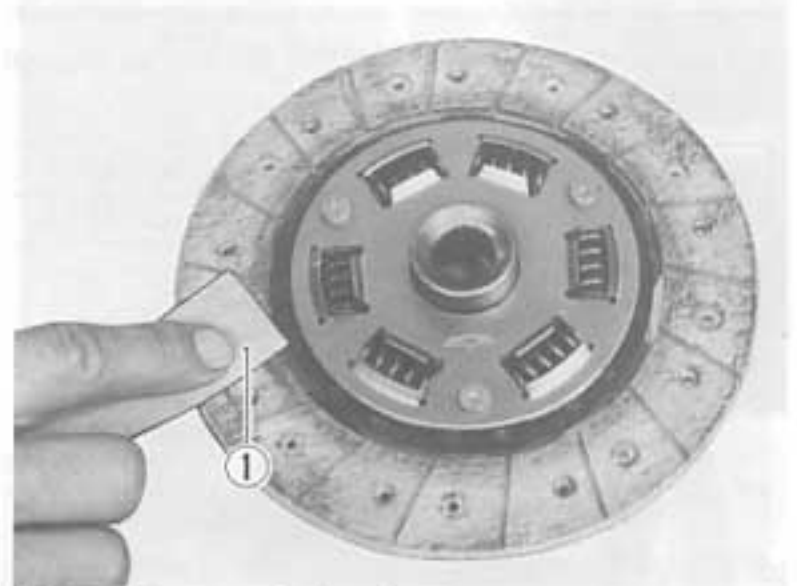


Fig. 12-4 ① Sandpaper

### Clutch facing wear

Check the wear of the facing by measuring the depth of each rivet head depression, which is the distance between rivet head and facing surface. If the depth is found to have reached the service limit at any of the holes, replace the clutch disc assembly.

Rivet head depression	Standard	Service limit
	1.2 mm (0.05 in.)	0.5 mm (0.02 in.)



Fig. 12-5

### Backlash in disc serration fit

Check the backlash by turning the disc back and forth as mounted on the transmission input shaft. Replace the disc assembly if the backlash is noted to exceed the limit. Backlash here is a circular displacement as measured with a dial indicator.

A clutch disc exhibiting a large backlash will make an impact noise each time the clutch is engaged, and will prevent the clutch to engage smoothly.

Backlash in serration fit	Service limit
	0.5 mm (0.02 in.)

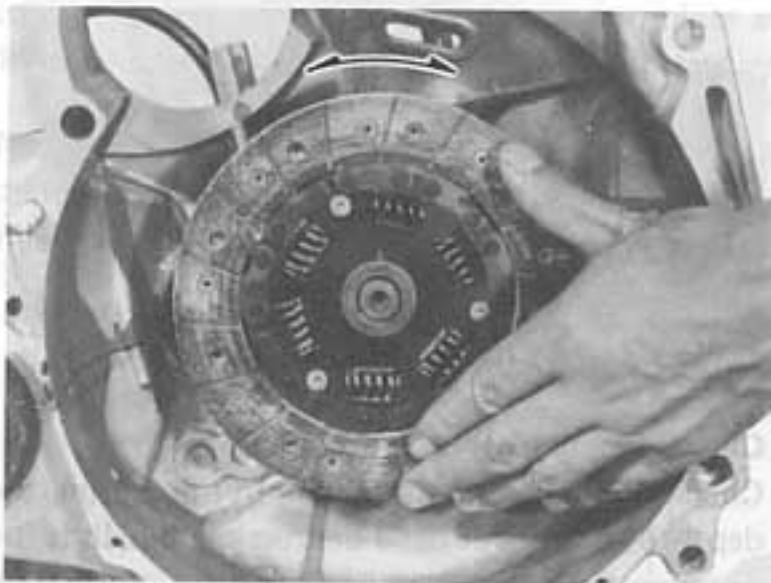


Fig. 12-6

### Clutch cover

Inspect the clutch cover for evidence of the diaphragm spring rivets getting loose. If the rivets are loose or are tending to become loose, replace the cover assembly; such a cover makes a rattling noise when the clutch pedal is depressed.

Inspect the tips of the tapering fingers (to which the release bearing exerts a push to disengage the clutch) for wear. If the tips are worn excessively, replace the cover assembly.

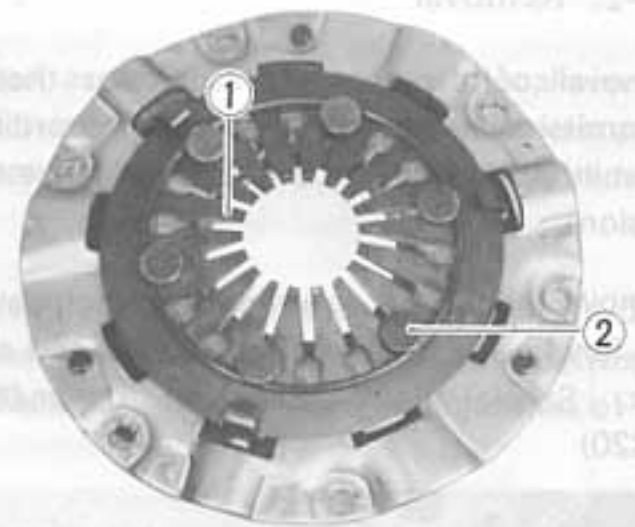


Fig. 12-7 ① Spring wear, ② Rivet

### Release bearing

Replace the release bearing if it sticks, rattles or makes an abnormal noise when spun and turned by hand.



Fig. 12-8

### Clutch cable lubrication

Apply grease to the hook part ③ of clutch cable.

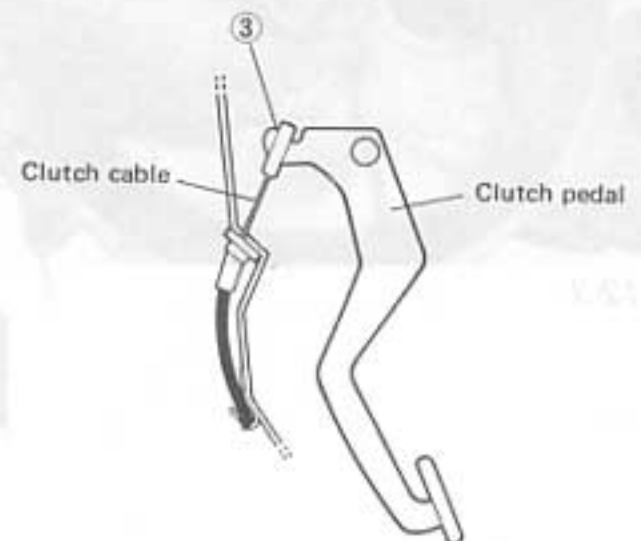


Fig. 12-9

### Clutch pedal play

Adjust the clutch pedal play with the adjuster nut ① (transmission case side). If the play is still too large after adjustment, readjust with the adjuster nut ② (clutch lever side).

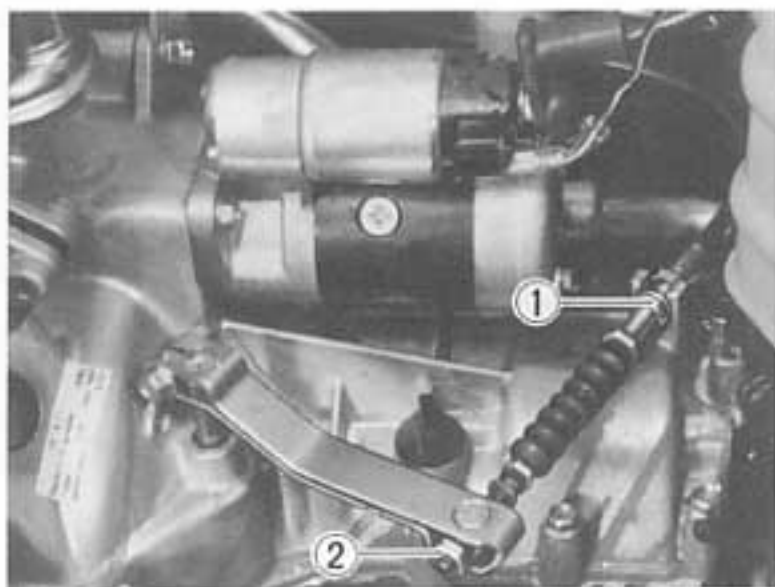


Fig. 12-10

#### NOTE:

If there is no clutch pedal play the clutch cable must be adjusted. If this is necessary, a worn clutch disc is considered to be a possible cause. If clutch operation is still not smooth after adjustment of cable play, check the disc for wear.

Clutch pedal play ③	15 ~ 25 mm (0.6 ~ 1.0 in.)
Clutch release arm play	2~4 mm (0.08~0.16 in.)

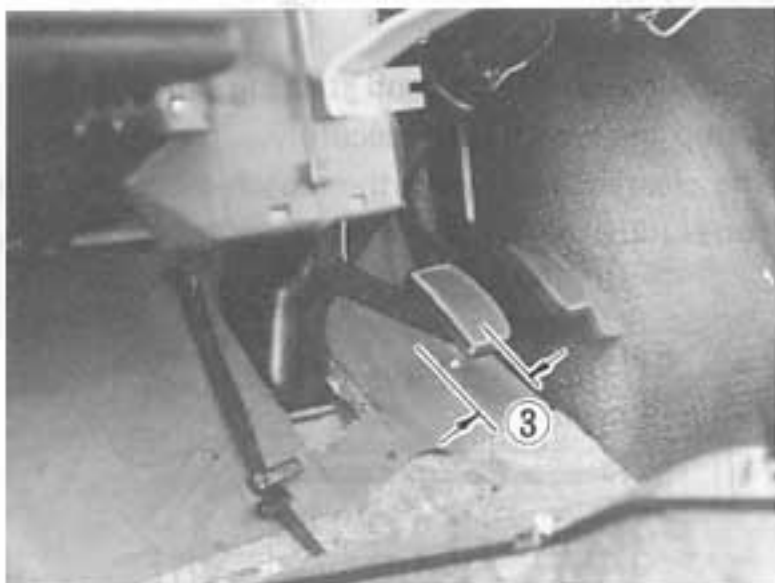


Fig. 12-11

### Clutch pedal height

Adjust the height of the clutch pedal with the stopper bolt above the clutch pedal, so that the pedal is level with the brake pedal.

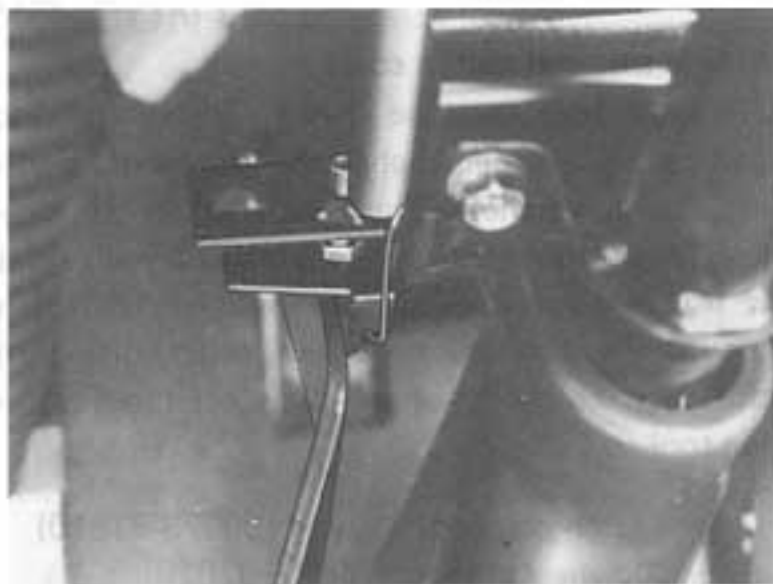


Fig. 12-12

### Clutch cable

Check the clutch cable for breaks, clamping condition, working condition, etc., and replace if any defect is found.

## 12-4. Installation

The clutch is to be installed by reversing the removal procedure. Some important steps will be explained in detail.

### Clutch disc and clutch cover

A special tool must be used to install the disc and cover, in order to align the two to the transmission input shaft. The tool is a sort of dummy; insert it into the crankshaft and flywheel (as if it were the transmission input shaft). Then mount the disc and cover and, after bolting up the cover to the flywheel, draw off the mounting tool (A).

(A) : Clutch disc center guide (09923-37810)

(B) : Flywheel stopper (09916-97820)

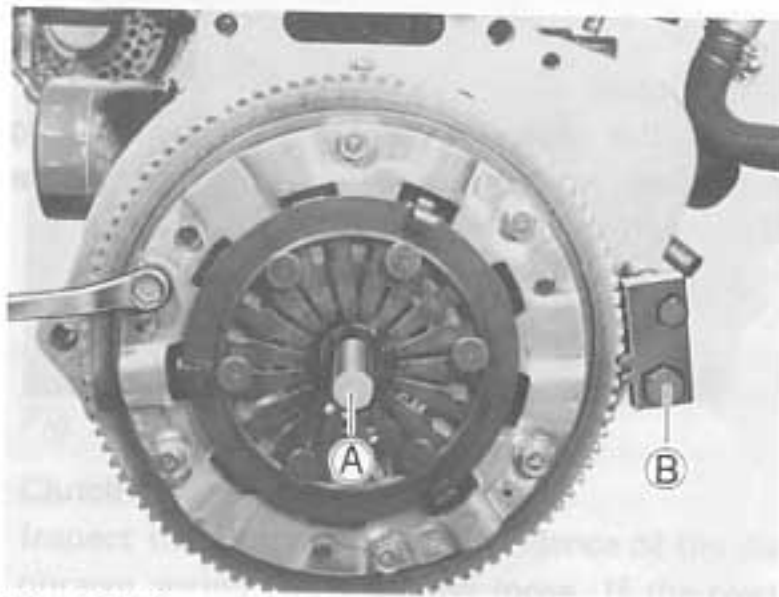


Fig. 12-13

When mounting the clutch cover on the flywheel, do not forget the 2 reamer bolts (1).



Fig. 12-14

### Clutch release bearing retainer

Before installing the retainer, apply SUZUKI SUPER GREASE "A" to the inner surface.

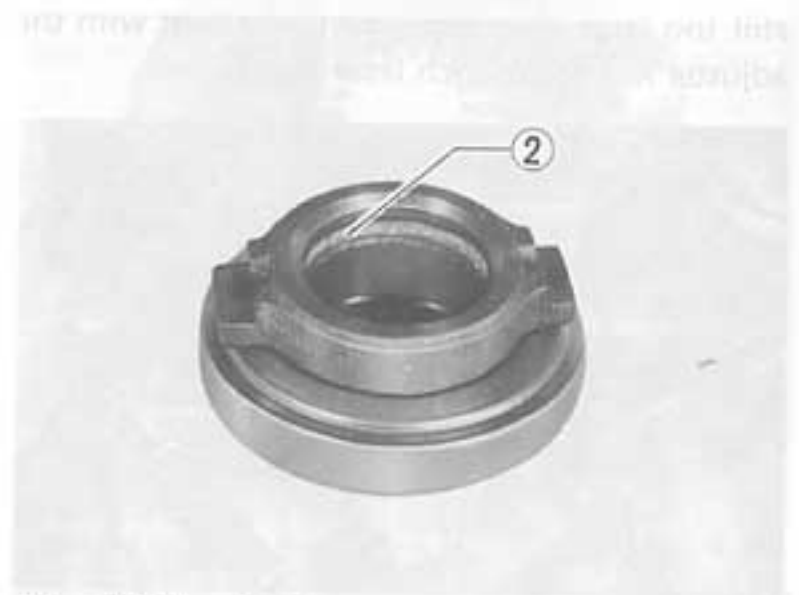


Fig. 12-15 (2) Grease

### Clutch release arm

Install the clutch release arm on the clutch release shaft in such a way that the punched mark on the clutch release arm is shifted toward the front side by one notch from the punched mark on the clutch release shaft.

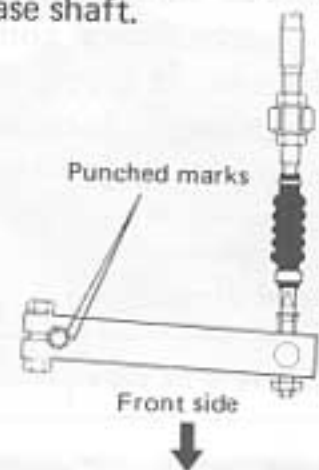


Fig. 12-16

### Clutch cable (Right hand steering vehicle)

Clamp the clutch cable securely.

The clearance between the clutch cable and the body must be more than 15 mm (0.59 in.).

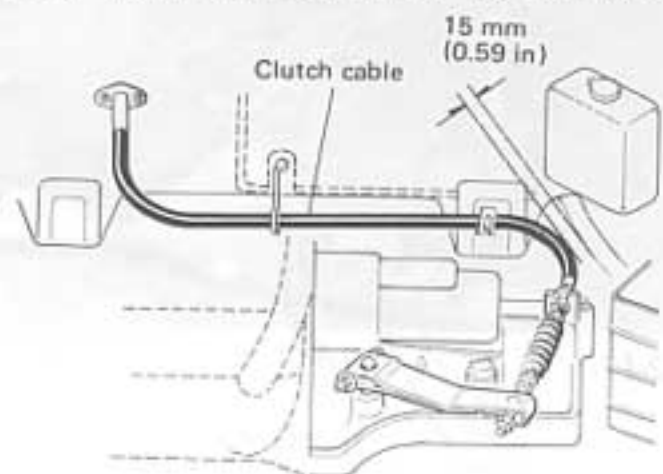


Fig. 12-17



## 13-1. Description

The movement of the gearshift lever is transmitted by the control shaft to the transmission case, and the three fork shafts are actuated selectively to shift the transmission.

Such component parts as the gear shift control lever housing, extension rod and guide plate are designed as suspended type so that the engine vibration propagated to the gear shift control lever is decreased.

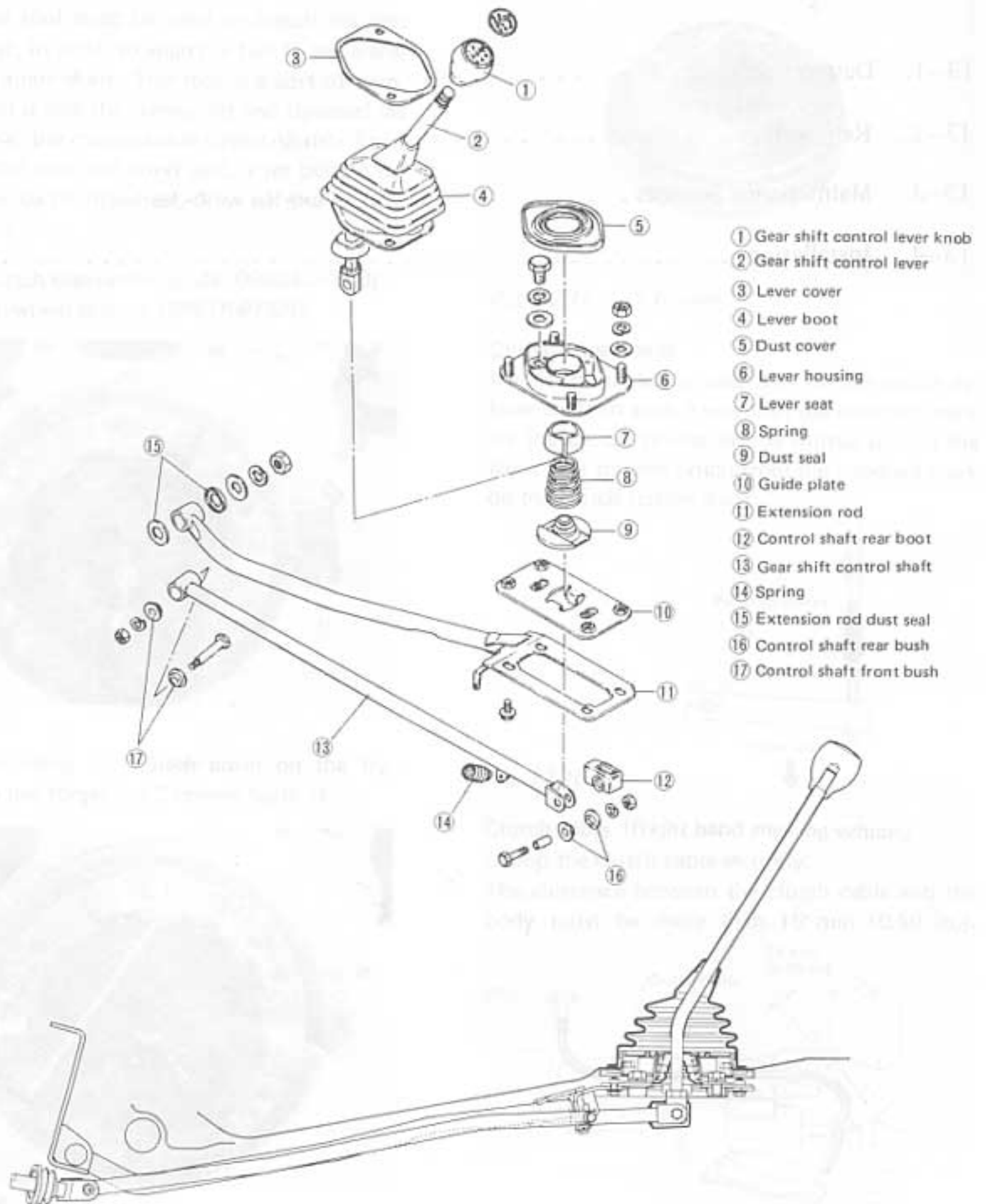


Fig. 13-1

## 13-2. Removal

### Gearshift control lever

Remove the gearshift control lever according to the following procedure.

- 1) Remove the gearshift control lever housing nuts (4 pcs) and bolts (2 pcs).

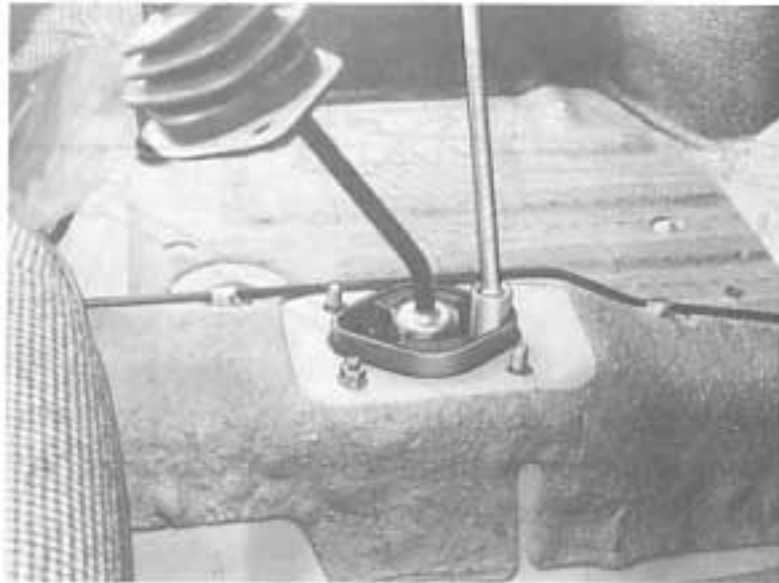


Fig. 13-2

- 2) Lift the front end of the machine by jacking, and support it on safety stands.
- 3) Remove the lever joint and the return spring on the bottom of the body.
- 4) Remove the extension rod.



Fig. 13-3

- 5) Pull out the gearshift control lever downward.

### Gearshift control shaft

To remove the control shaft, remove bolt ① connecting the gearshift control shaft and the gearshift shaft on the transmission side. Then remove return spring ② and bolt ③ from the control shaft.

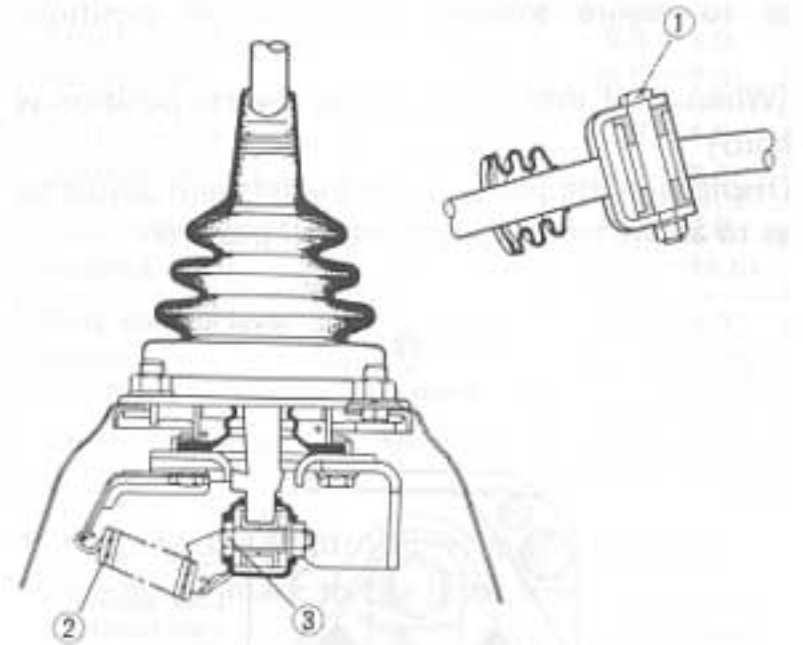


Fig. 13-4



## 13-3. Maintenance Services

### Gearshift lever adjustment

[When shift into low or second position is hard]  
Loosen gearshift control lever housing bolts ④, displace guide plate ⑤ to the right and adjust so as to assure smooth shift into all position.

[When shift into third, top or reverse position is hard]

Displace guide plate ⑤ to the left and adjust so as to assure smooth shift into all position.

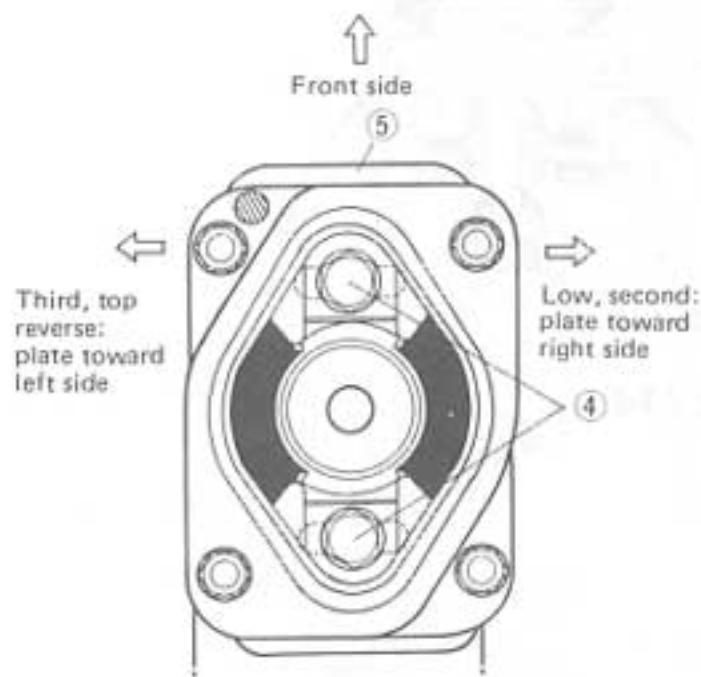


Fig. 13-5

[When each shift stroke is short]  
[When gears are not in complete mesh]  
Loosen gearshift control lever housing nuts ⑥ and guide plate bolts ⑦. Adjust the guide plate ⑤ by displacing it toward front and rear so that gearshift control lever ⑧ is brought in the middle of the guide plate and at the right angle.

#### NOTE:

Once guide plate ⑤ is positioned properly, tighten the guide plate bolts ⑦ and then housing nuts ⑥.

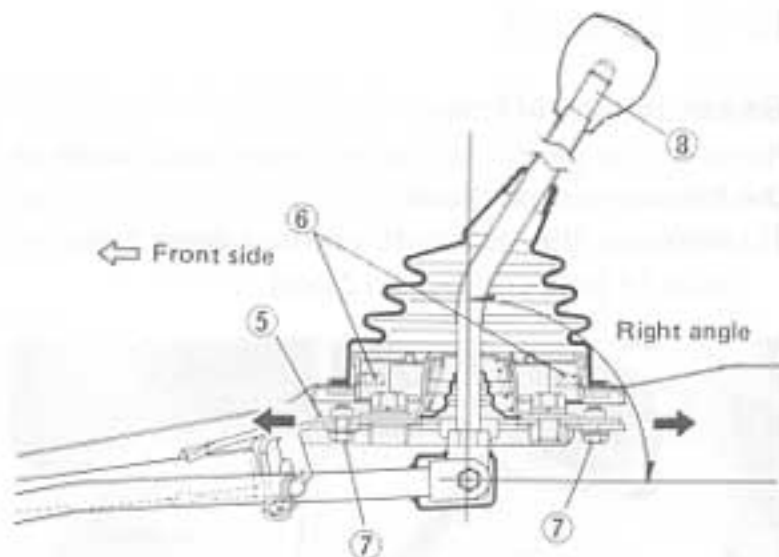


Fig. 13-6

### Guide plate inspection

Replace the guide plate if its tongued parts "A" and "B" are excessively worn.

If part "A" becomes worn, the gear tends to be shifted to reverse when shifting to top gear.

If part "B" becomes worn, neutral position of the shift lever will be changed.

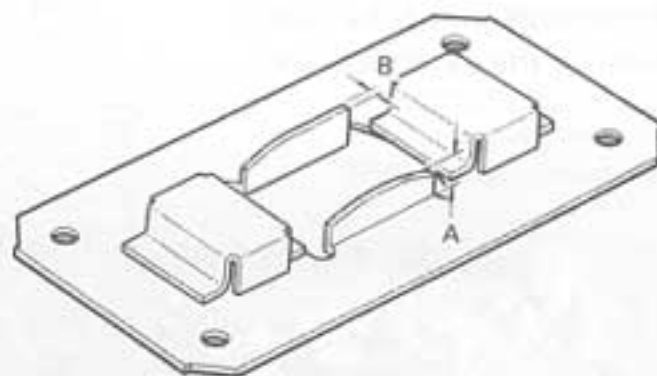


Fig. 13-7

### Gear shift lever inspection

Check the lever top for wear and replace if it is found to be worn.

### Boot and bush inspection

Check the boot for damage and replace if defective. Check the bush for damage and replace if defective.

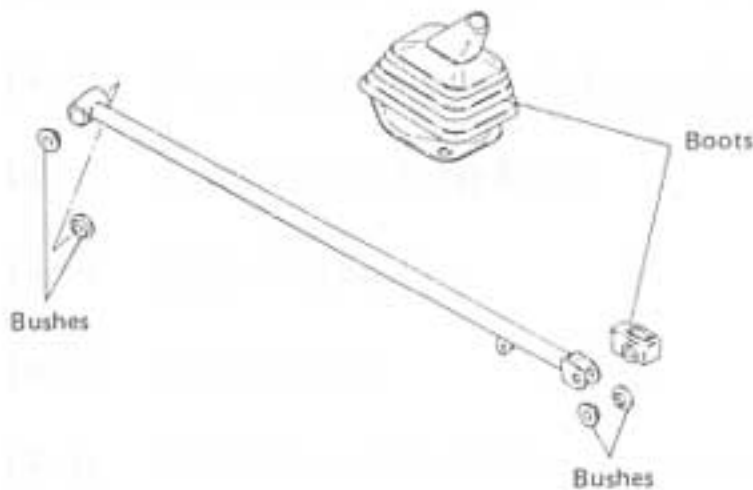


Fig. 13-8

### Gearshift lever housing inspection

Check the rubber for damage or crack and replace if defective.

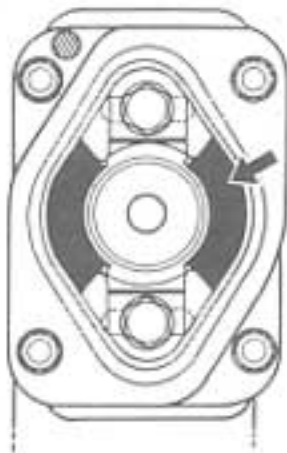


Fig. 13-9

## 13-4. Installation

### • Tightening torque

To be tightened to:	N.m	kg-m (lb-ft)
Rear nut, gearshift control rod	8 ~ 10	0.8 ~ 1.0 (5.5 ~ 7.5)
Front nut, gearshift control rod	8 ~ 10	0.8 ~ 1.0 (5.5 ~ 7.5)
Bolt, control lever guide plate	8 ~ 10	0.8 ~ 1.0 (5.5 ~ 7.5)
Nut, control lever housing	15 ~ 20	1.5 ~ 2.0 (10.5 ~ 14.5)
Bolt, control lever housing	25 ~ 40	2.5 ~ 4.0 (18.0 ~ 29.0)
Extension rod nut	25 ~ 40	2.5 ~ 4.0 (18.0 ~ 29.0)

- Position the control lever guide to bring the arrow mark to the front side.

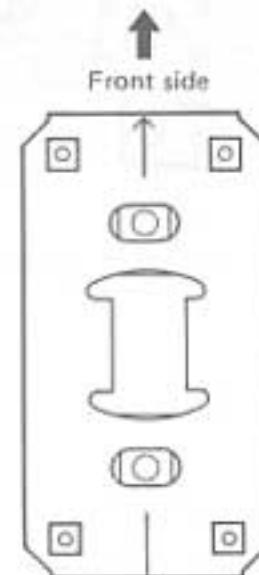


Fig. 13-10

- Points to be greased.

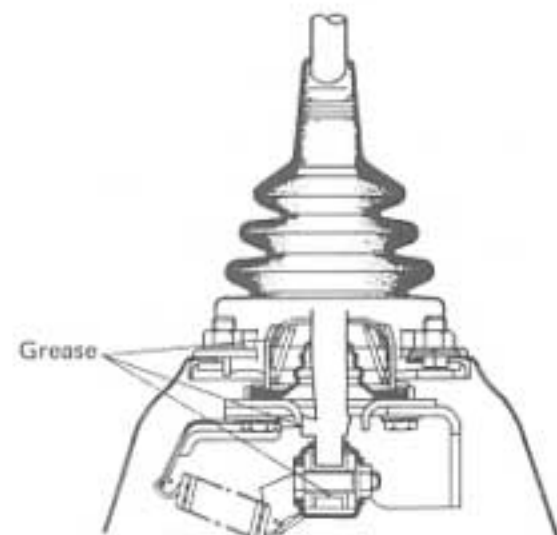


Fig. 13-11

- The control lever must be in the center of the guide plate and at the right angle as shown in Fig. 13-12.

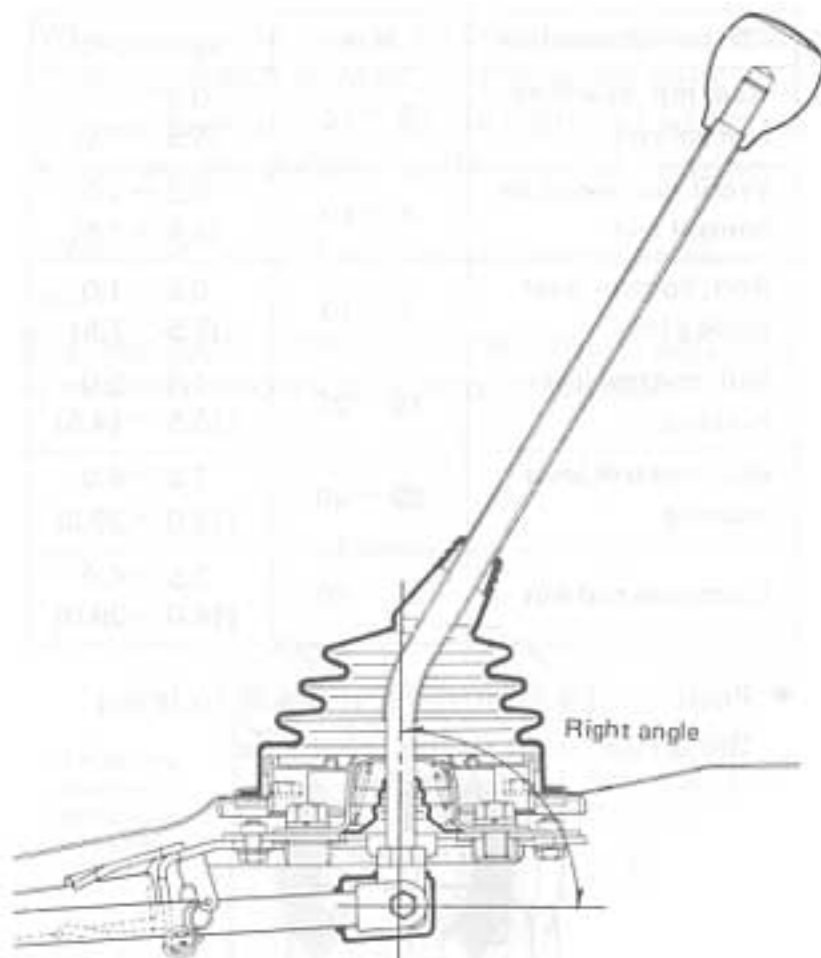


Fig. 13-12

NOTE:

Check guide plate for correct position. When the lever is in the right position, the lever will be in the center of the guide plate.



## 14-1. Description

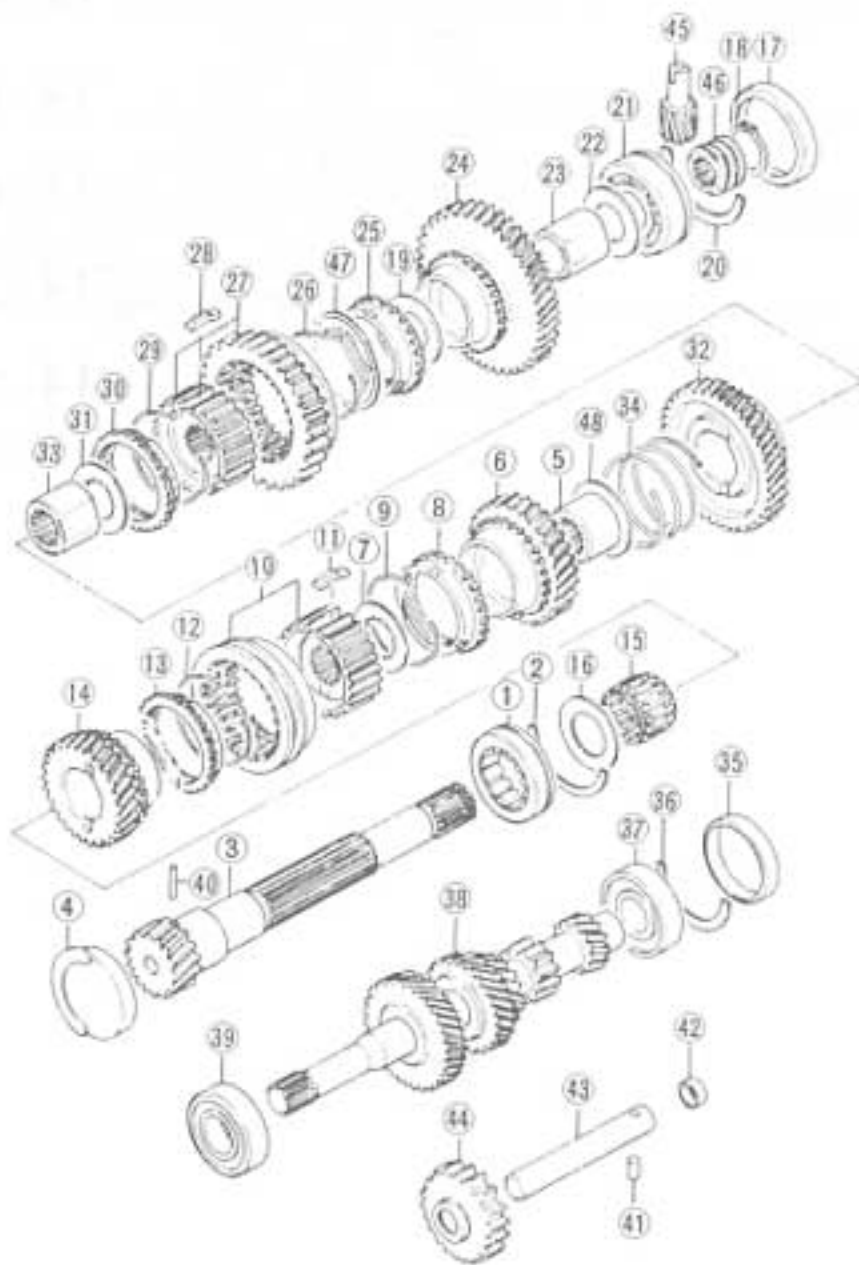
The transmission is full synchronized and provides four forward speeds and one reverse speed by means of two synchronizers and two shafts-input shaft and countershaft.

Gears on both shafts (input and counter) are always meshed. The low-speed synchronizer on the counter shaft is engaged either with the low driven gear or second driven gear. The high-speed synchronizer is engaged with either the third driven gear or top driven gear. The reverse idler gear is of clash-meshing type and is engaged with the low speed synchronizer sleeve on the countershaft and the reverse drive gear on the input shaft.

Transmission case is in two-piece construction, consisting of upper case and lower case.

The lower case has the three-fork-shifting mechanism built in it.

The upper case houses the reverse shaft.



- |                          |                                  |
|--------------------------|----------------------------------|
| 1. Counter shaft bearing | 25. Synchronizer ring            |
| 2. C ring                | 26. Synchronizer spring          |
| 3. Counter shaft         | 27. Low speed hub set            |
| 4. Bearing plug          | 28. Synchronizer key             |
| 5. Spacer                | 29. Synchronizer spring          |
| 6. Third gear            | 30. Synchronizer ring            |
| 7. Thrust washer         | 31. Thrust washer                |
| 8. Synchronizer ring     | 32. Second gear                  |
| 9. Synchronizer spring   | 33. Spacer                       |
| 10. High speed hub set   | 34. Spring                       |
| 11. Synchronizer key     | 35. Bearing plug                 |
| 12. Synchronizer spring  | 36. C ring                       |
| 13. Synchronizer ring    | 37. Bearing                      |
| 14. Top gear             | 38. Input shaft                  |
| 15. Bearing              | 39. Bearing                      |
| 16. Thrust washer        | 40. Pin                          |
| 17. Bearing plug         | 41. Reverse gearshaft pin        |
| 18. Circlip              | 42. Plug                         |
| 19. Thrust washer        | 43. Reverse shaft                |
| 20. C ring               | 44. Reverse idle gear            |
| 21. Bearing              | 45. Speedometer driven gear      |
| 22. Thrust washer        | 46. Speedometer drive gear       |
| 23. Bush                 | 47. Synchronizer low gear spring |
| 24. Low gear             | 48. Thrust washer                |

Fig. 14-1

## 14-2. Flow of Drive Through Transmission

How drive flows will be explained for each shift position:

### **Low speed drive**

Low driven gear on the countershaft is free from this shaft and merely rotates around it, as driven from the low drive gear of the input shaft. Shifting the lever into "low" causes low-speed gear shifter fork to push low-speed synchronizer toward low driven gear and, through the dog teeth, mesh it with the gear, thus coupling the gear to the input shaft.

In this condition, the drive is transmitted through the low drive gear on the input shaft and low driven gear on the countershaft to the final gear of the differential.

### **Second speed drive**

Shifting the lever into "second" causes the same low-speed gear shifter fork to push low-speed synchronizer to the other direction, that is, toward second driven gear and mesh it with this gear, thereby coupling the gear to the input shaft.

In this condition, the drive is transmitted through the second drive gear on the input shaft and second driven gear on the countershaft to the final gear of the differential.

### **Third speed drive**

Shifting the lever into "third" actuates high-speed shifter fork to engage high-speed synchronizer with third driven gear on the countershaft. This gear, like low and second driven gears, is free on the shaft and merely spins as driven by third drive gear of input shaft when the gearshift lever is any other position.

In this condition, the drive is transmitted through the third drive gear on the input shaft and third driven gear on the countershaft to the final gear of the differential.

### **Top speed drive**

Shifting the lever into top causes the high-speed shifter fork, which is also used for the third speed, to mesh the top gear with the high-speed synchronizer on the countershaft.

In this condition, the drive is transmitted through the top drive gear on the input shaft and top driven gear on the countershaft to the final gear of the differential.

### **Reverse drive**

Shifting the lever into reverse causes the reverse gear shifter fork to mesh the reverse idle gear with the reverse gear on the input shaft and the low speed synchronizer sleeve on the countershaft.

In this condition, the drive is transmitted through the reverse gear on the input shaft, reverse idle gear and low-speed synchronizer on the countershaft to the final gear of the differential.



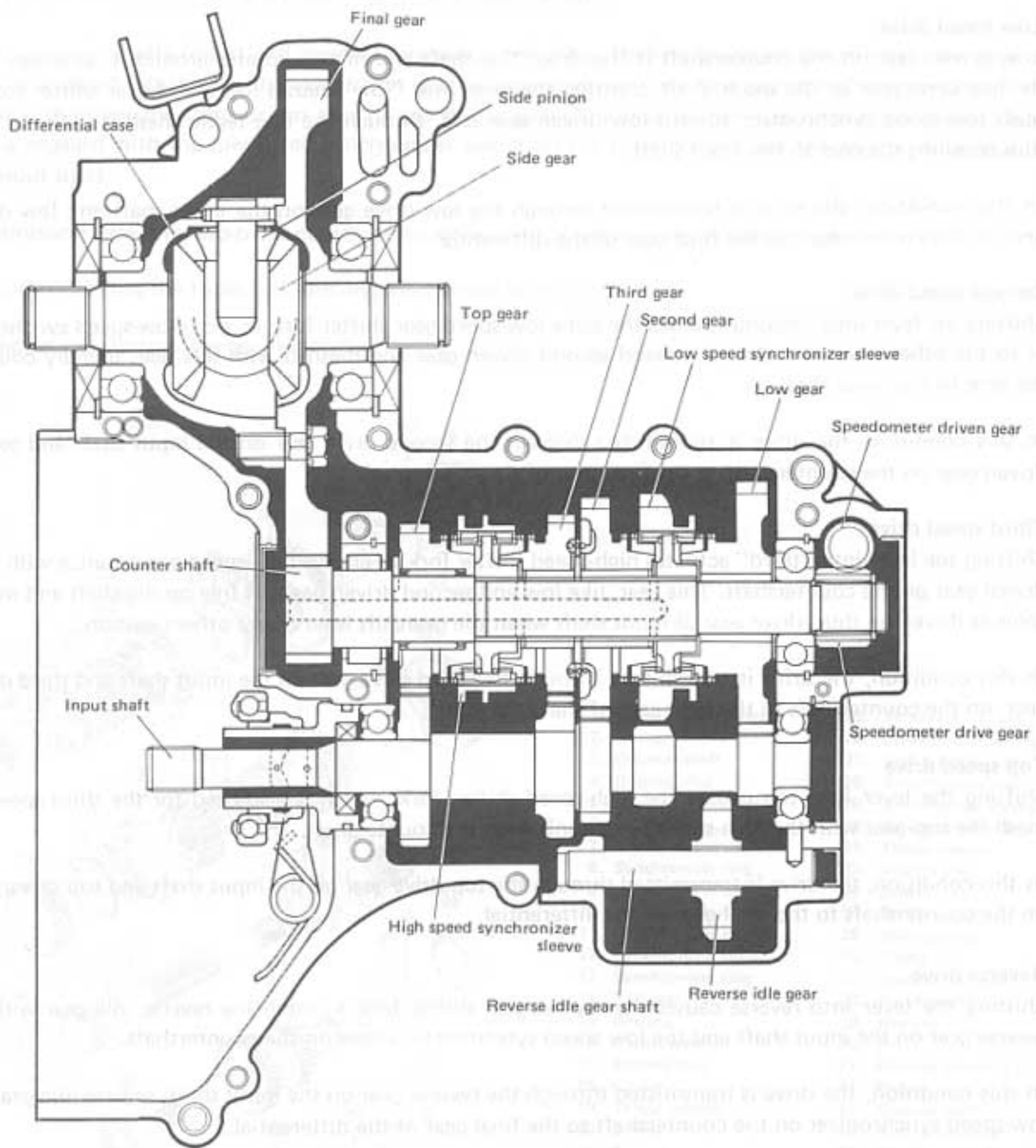


Fig. 14-2



### 14-3. Transmission Gear Ratio

	Gear ratio	Speed ratio
Final reduction ratio	90/17	5.294
Shift position	Low	43/12
	Second	39/18
	Third	33/24
	Top	28/30
	Reverse	37/22 x 22/11

### 14-4. Dismounting

When servicing the transmission or differential, the procedure is as follows (when the engine is not removed);

**NOTE:**

A transmission jack is required for this work. If no transmission jack is available, it is recommended to demount the transmission and differential together with the engine referring to the item on engine removal.

- 1) Disconnect the negative (-) and positive (+) lead wires from the battery terminals.
- 2) Remove the battery ass'y.
- 3) Jack up the front body.



Fig. 14-3

- 4) Support the body on safety stands.



Fig. 14-4

- 5) Remove the front grille.
- 6) Remove the front upper member.

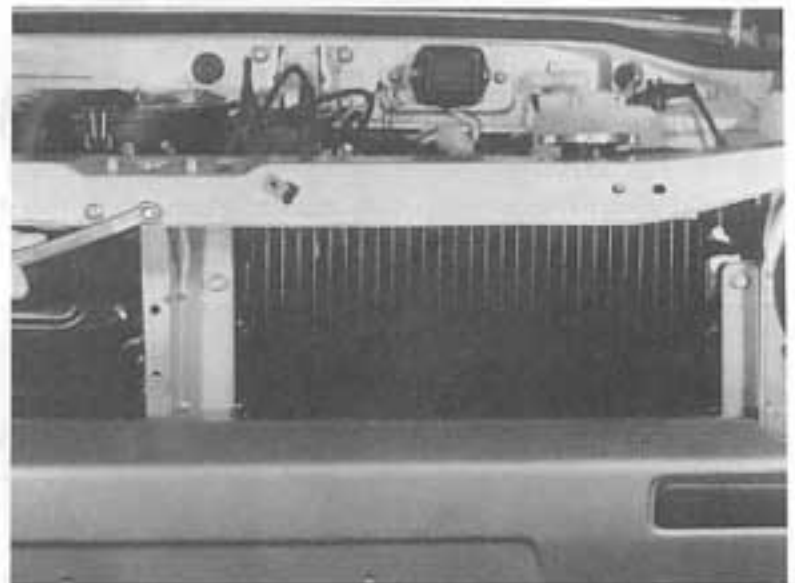


Fig. 14-5

- 7) Loosen the drain plug ① on the radiator to empty its water.

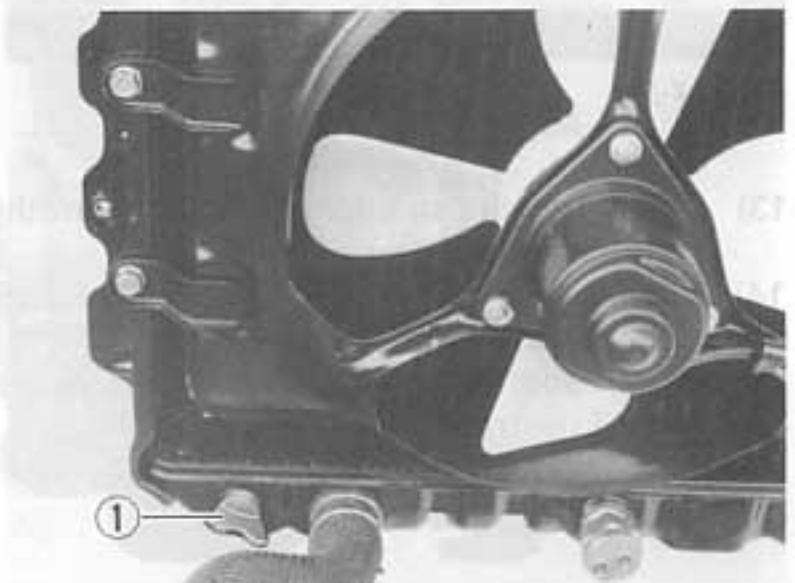


Fig. 14-6

- 8) Disconnect the radiator fan lead wire at the coupler.
- 9) Disconnect the radiator inlet and outlet hoses at the joint part, and then remove the radiator outlet pipe and radiator.

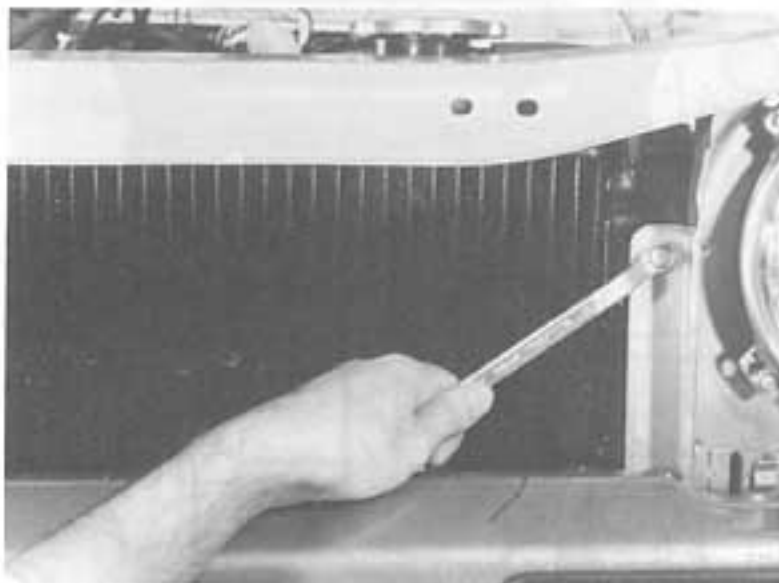


Fig. 14-7

- 10) Remove the starter motor.
- 11) Disconnect the back light switch lead wire at the coupler.
- 12) Disconnect the clutch cable from the clutch lever and adjusting part.

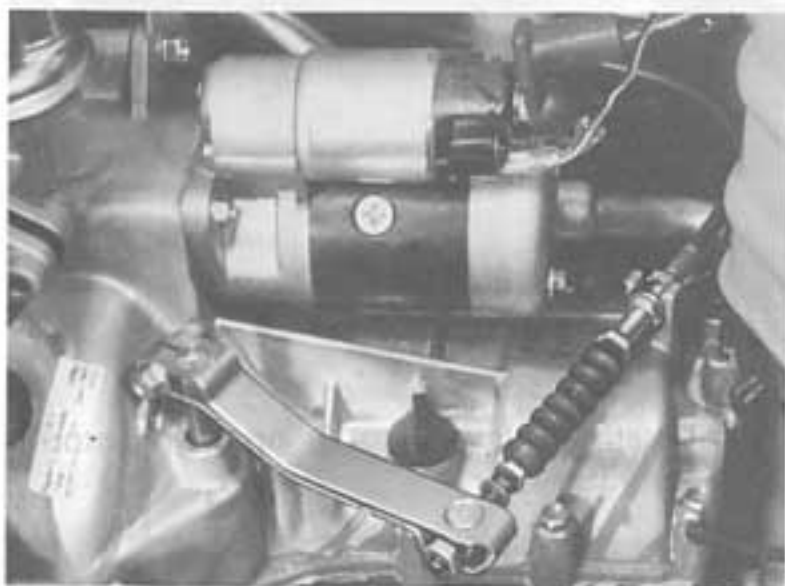


Fig. 14-8

- 13) Disconnect the speedometer cable from the transmission case.
- 14) Disconnect the fuel hose from the fuel filter outlet pipe.
- 15) Detach the gear shift control shaft at the joint of the transmission case side.

- 16) Detach the extension rod at the joint of the transmission case side.
- 17) Remove the clutch housing lower plate.
- 18) Remove the drain plug to drain out the oil in the transmission.



Fig. 14-9

- 19) Detach the drive shafts (L & R) from the snap rings of the differential side gears.

**NOTE:**

At this stage, the two drive shaft cannot be removed from the each side gear.

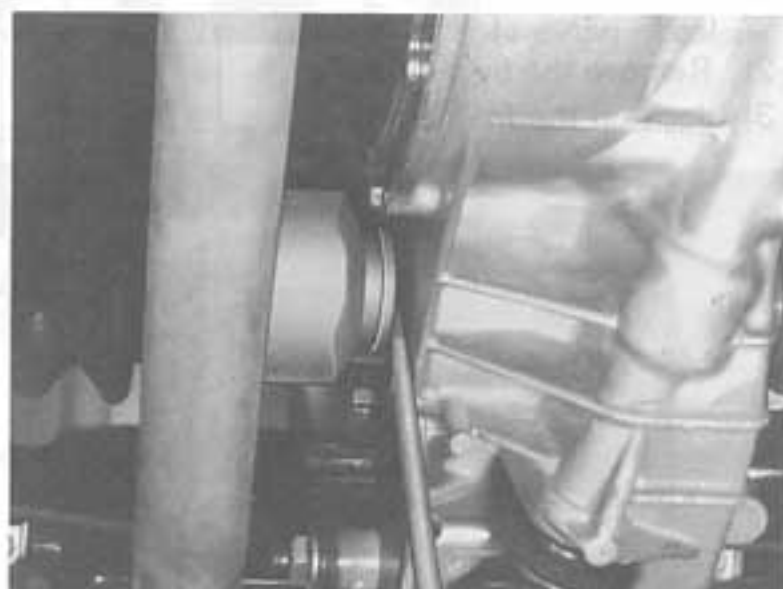


Fig. 14-10

- 20) Remove the left front wheel.

- 21) Detach the left tie rod end from the steering knuckle by using special tool  $\text{\textcircled{A}}$  (09913-65210).

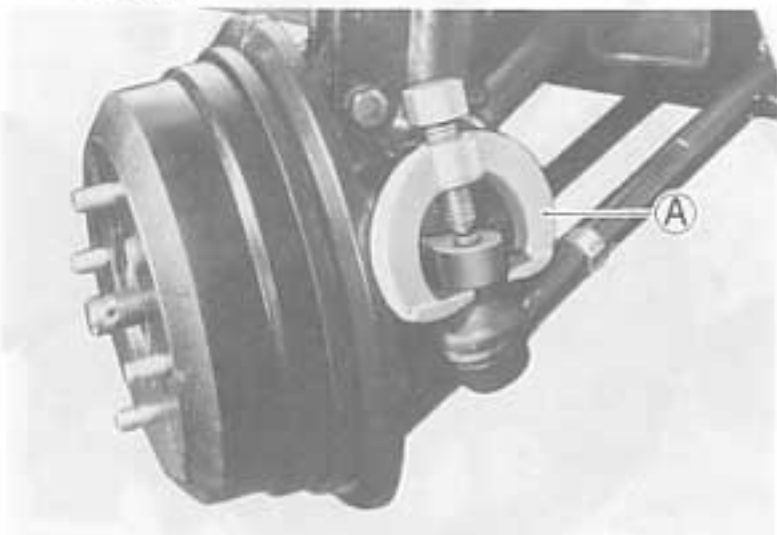


Fig. 14-11

- 22) Detach the front suspension left arm ball joint stud from the steering knuckle.



Fig. 14-12

- 23) Draw out the left drive shaft from the differential side gears.

**NOTE:**

At this time, be careful not to damage the brake flexible hose.



Fig. 14-13

- 24) Remove the torque rod engine side bracket.  
25) Remove the distributor gear case.

**CAUTION:**

Engine oil will come out of the distributor drive gear case when the distributor gear case is removed from the cylinder head. Never allow this oil to find its way onto the flywheel. Place a properly shaped pan to catch the oil.

- 26) Support the engine on a transmission jack.  
27) Remove the engine rear mounting and bracket from the body and transmission case.  
28) Remove the bolts and nuts fastening the engine and transmission case.

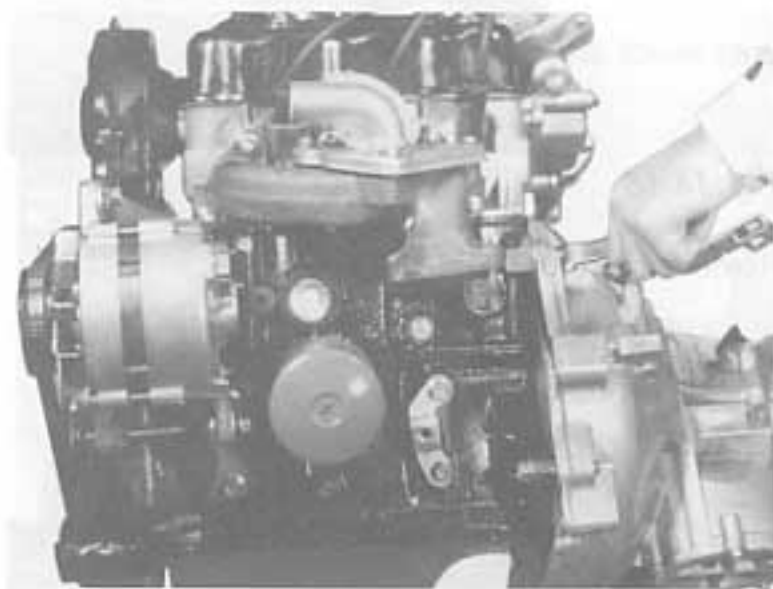


Fig. 14-14

**CAUTION:**

At this stage, make certain that no parts are connected to the transmission case.

- 29) Remove the engine left mounting and bracket.  
30) Remove the transmission.

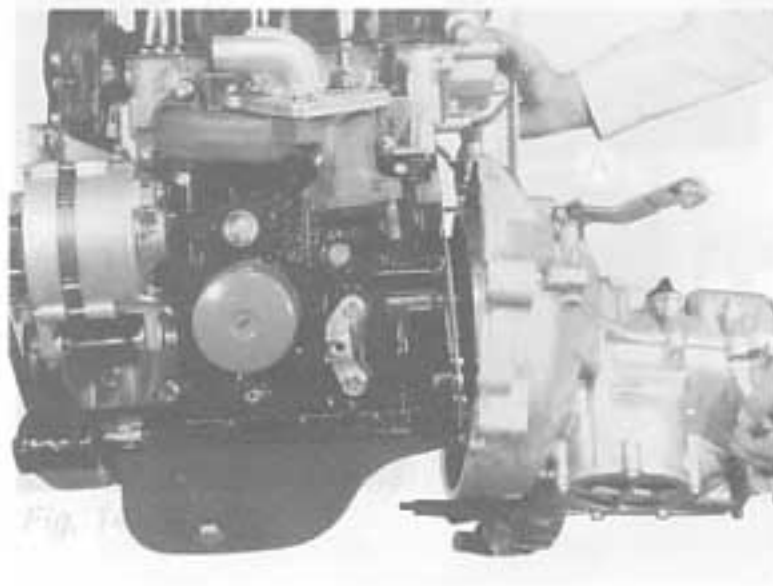


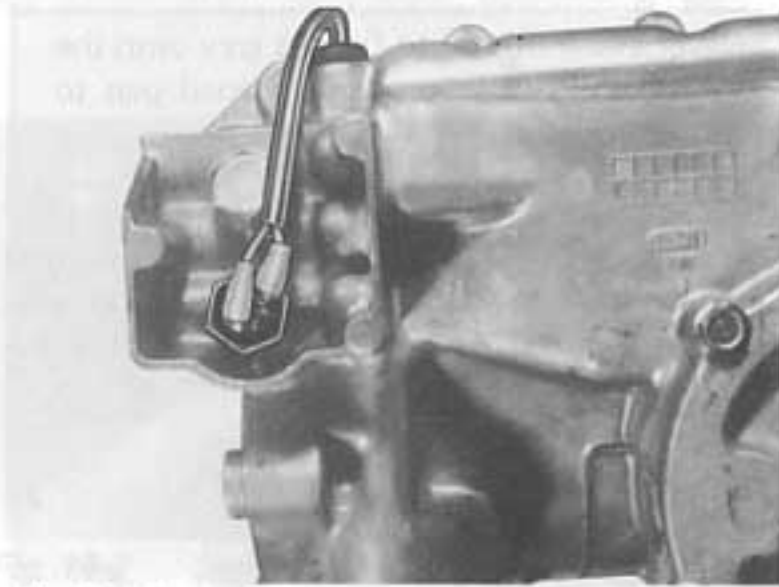
Fig. 14-15



## 14-5. Disassembly

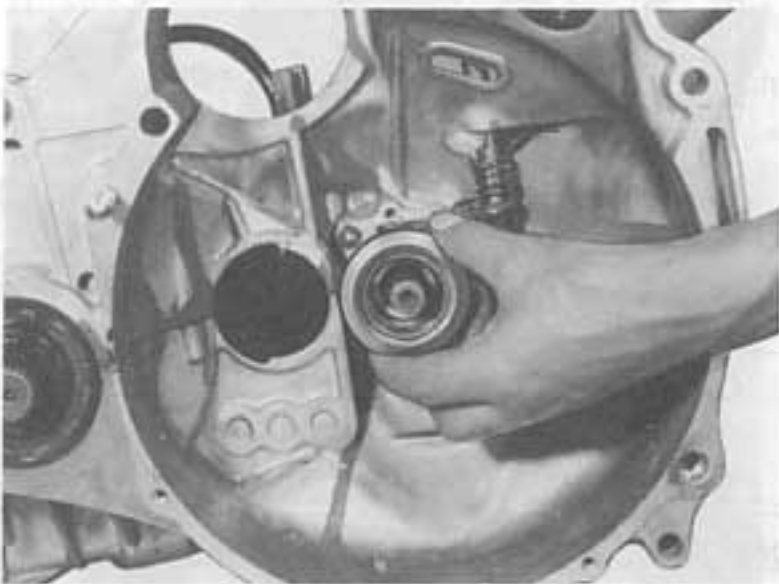
Disassemble procedure for the transmission and differential is as follows.

Remove the back up light switch.



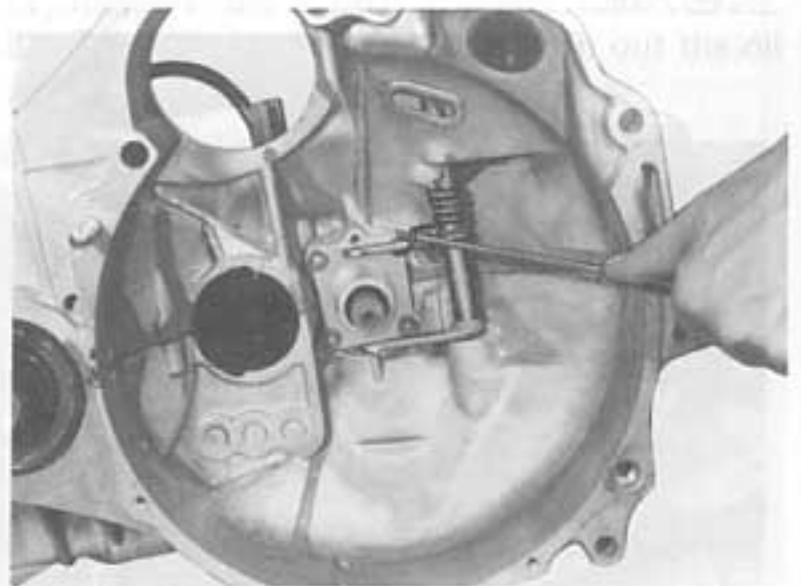
*Fig. 14-16*

Remove the clutch release bearing.



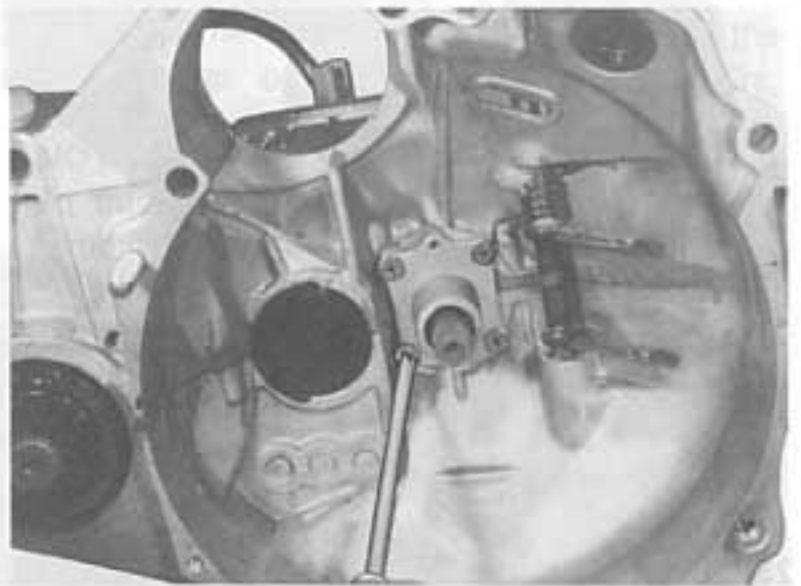
*Fig. 14-17*

Remove the clutch release shaft return spring from the release lever.

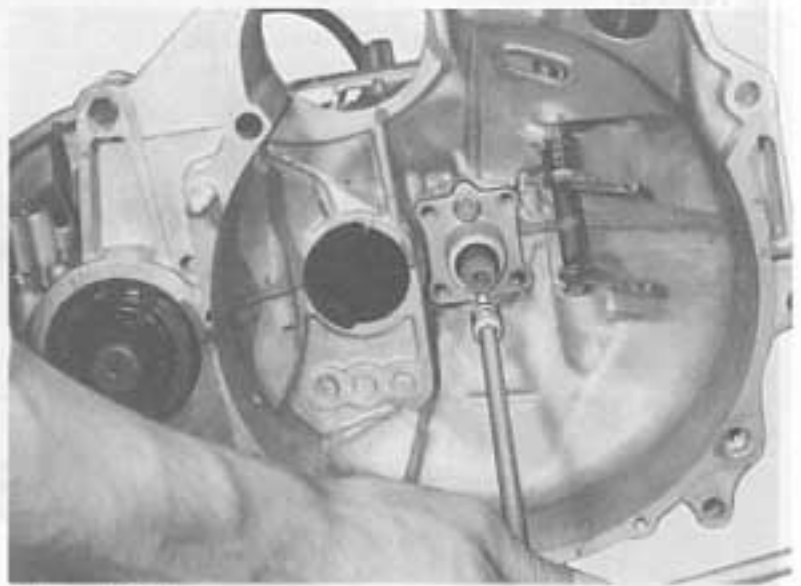


*Fig. 14-18*

Remove the clutch release bearing retainer. Inserting bolts in the upper and lower points of the retainer will facilitate removal.



*Fig. 14-19*



*Fig. 14-20*

Remove the bolts fastening the upper and lower cases.

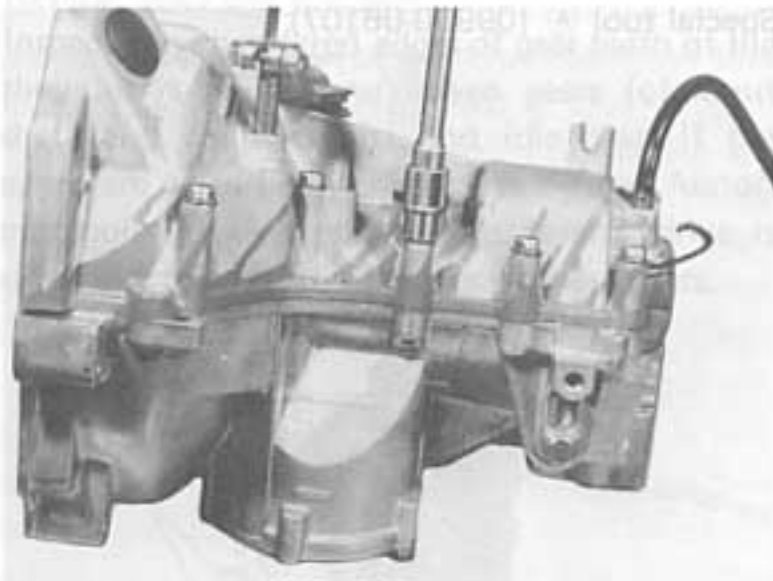


Fig. 14-21

Detach the lower and upper transmission cases.

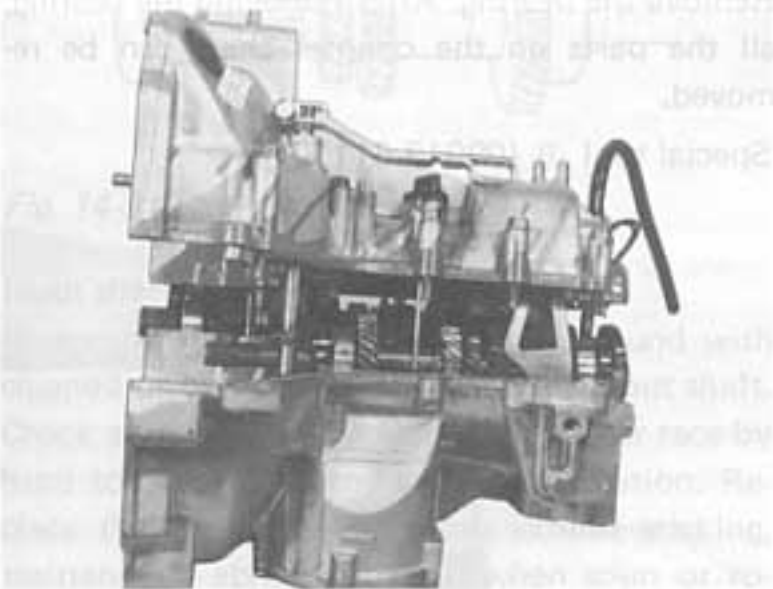


Fig. 14-22

When the upper case is removed, all parts should be left on the lower case.



Fig. 14-23

Remove the input shaft from the lower case.

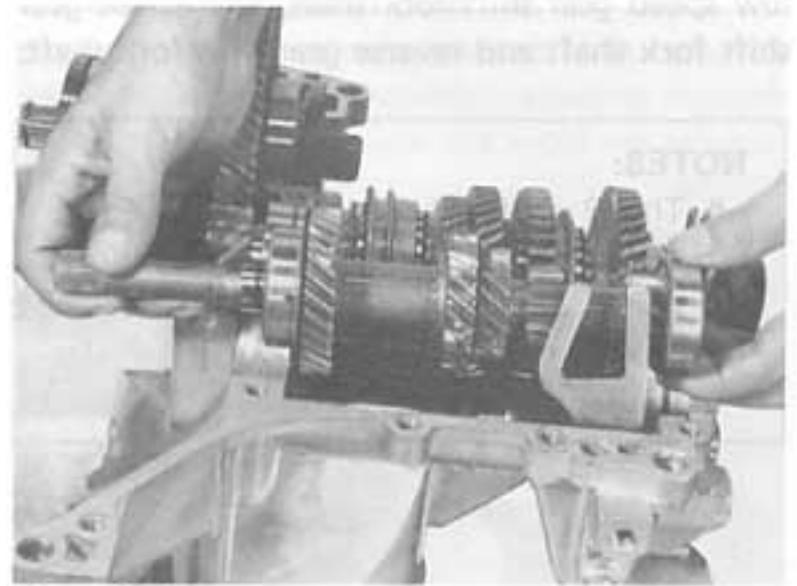


Fig. 14-24

Remove the counter shaft from the lower case.

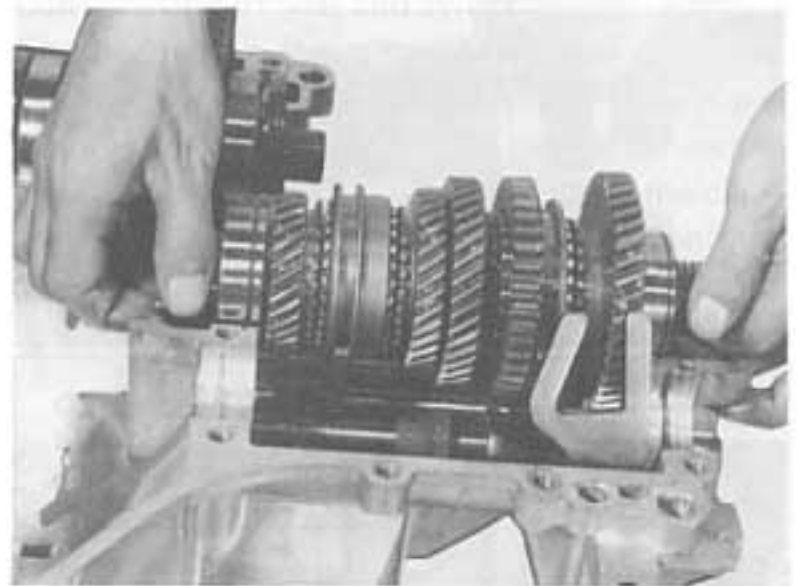


Fig. 14-25

Tap the spring pin out of the 3 shift fork shafts with special tool (A)

Special tool (A) (09922-85811)

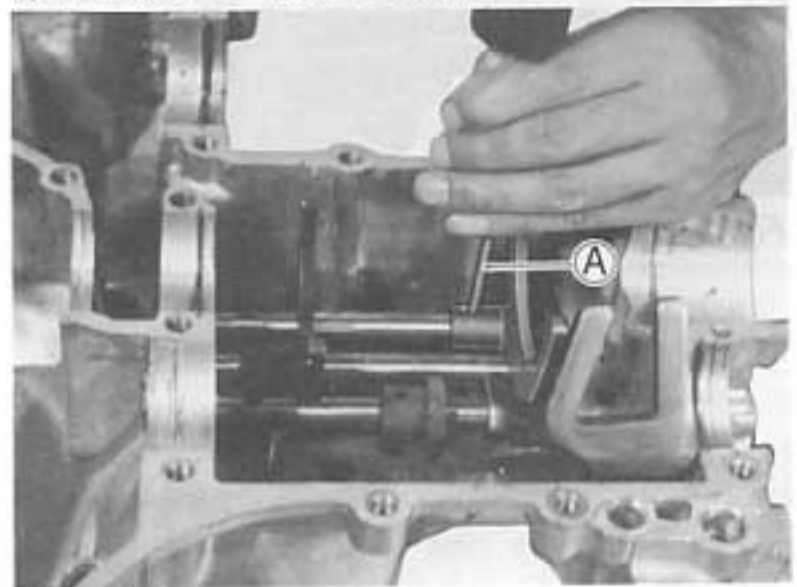


Fig. 14-26

Draw out the 3 shift fork shafts in the order of low speed gear shift fork shaft, high speed gear shift fork shaft and reverse gear shift fork shaft.

**NOTES:**

- The 2 shafts should be positioned at neutral when removing the shift fork shafts.
- Take care when drawing out the shafts so that the locating balls do not fall out.

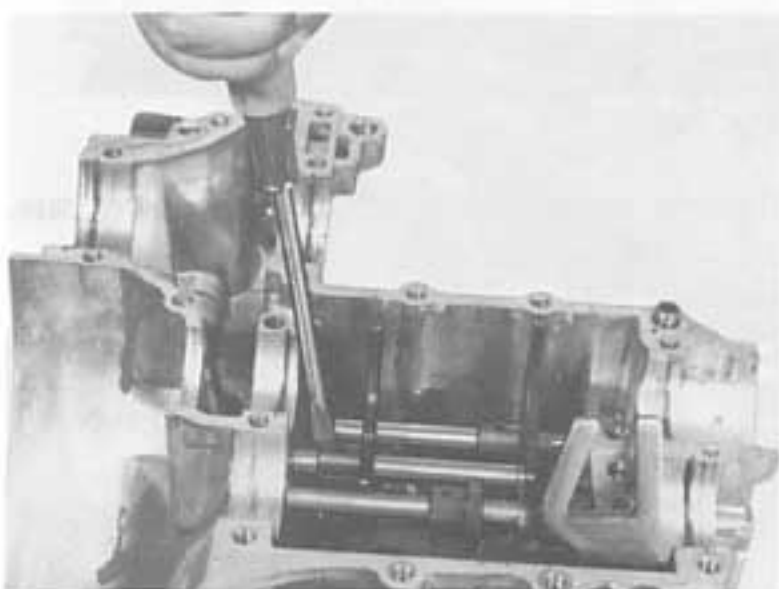


Fig. 14-27

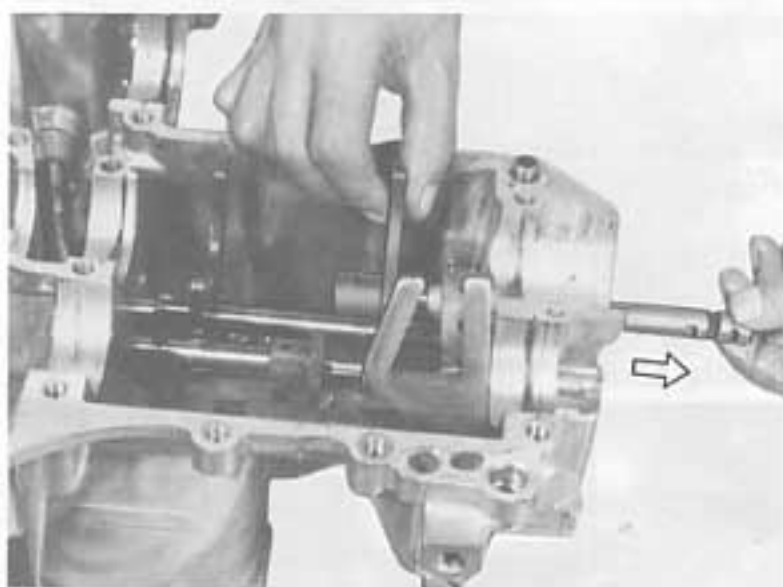


Fig. 14-28

After removing the circlip, draw out the speedometer drive gear.

Special tool **A** (09900-06107)

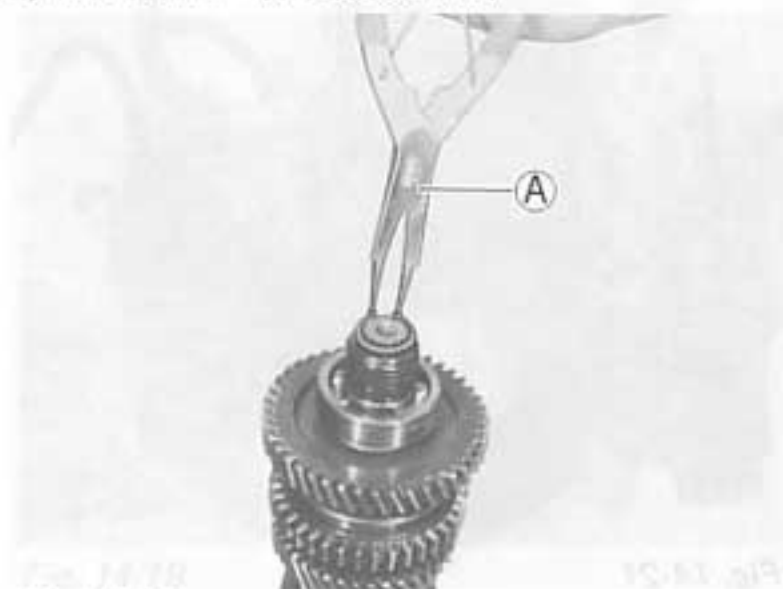


Fig. 14-29

Remove the bearing. After removing the bearing, all the parts on the counter shaft can be removed.

Special tool **B** (09913-61110)

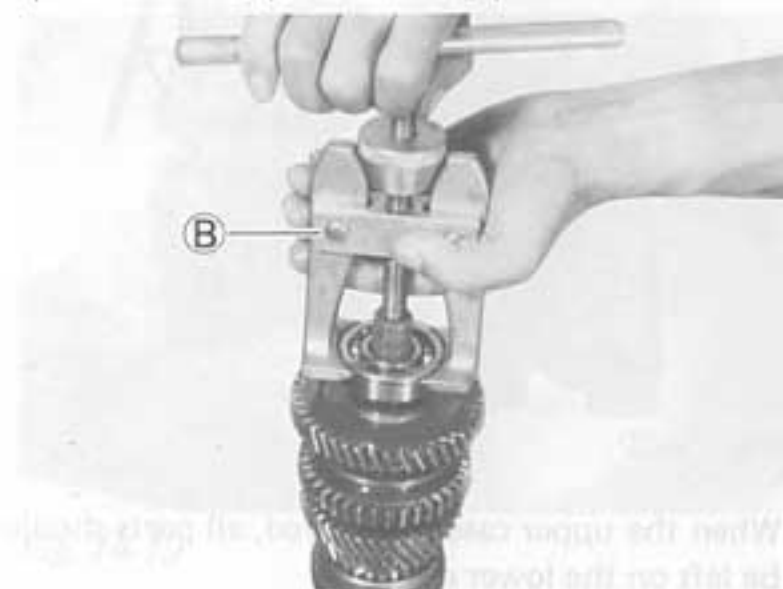


Fig. 14-30



## 14-6. Maintenance Services

### Reverse gears and idle gear

Inspect the chamfered edges of gear teeth of the three gears-driving and driven gears (of input shaft and countershaft) and idle gear. If the edges are worn badly, replace the gears. Abnormal noise of gear slipping in reverse drive is often due to worn tooth edges of these gears.

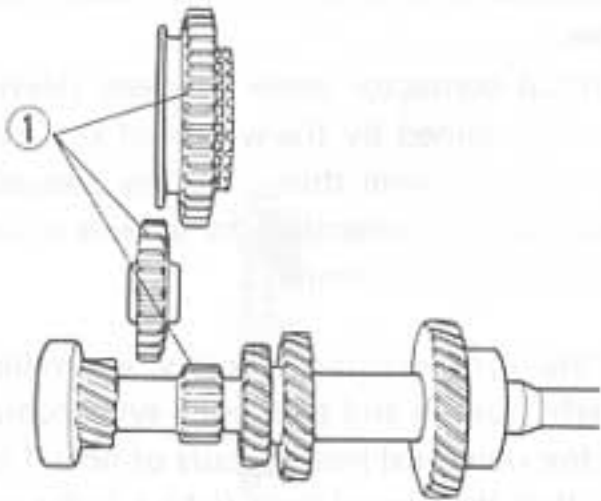


Fig. 14-31 ① Chamfered

### Input shaft and its bearings

If any of the input shaft gears is found with chipped or broken teeth, replace the input shaft. Check each bearing by spinning its outer race by hand to "feel" the smoothness of rotation. Replace the bearing if noted to exhibit sticking, resistance or abnormal noise when spun or rotated by hand.

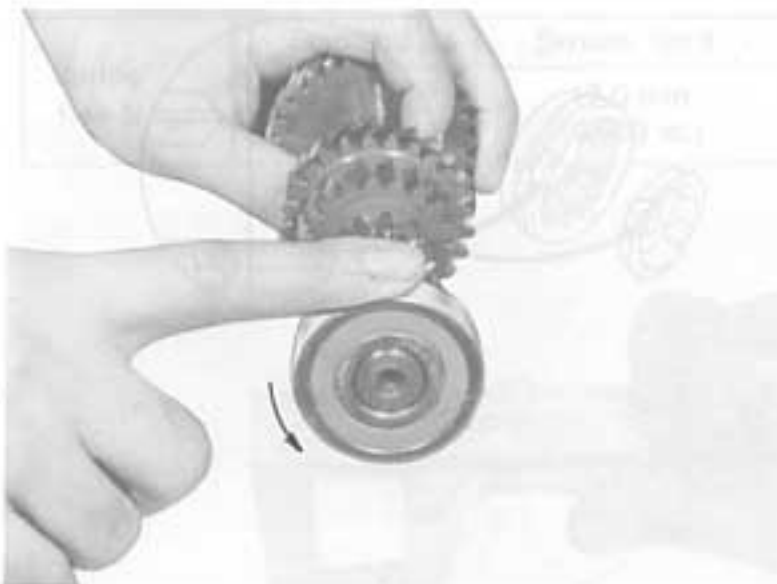


Fig. 14-32

Check the spline ② of the input shaft for wear and damage. Replace if defective.

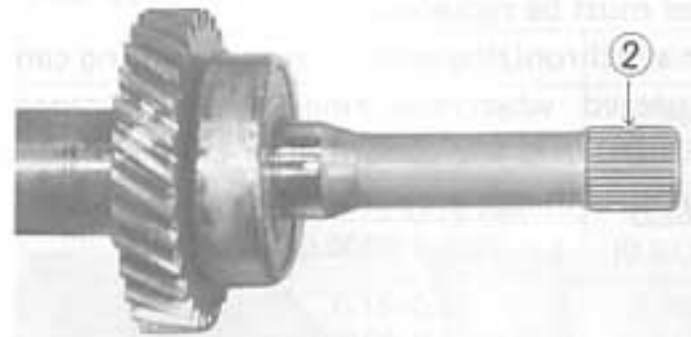


Fig. 14-33

### Combination of gear and synchronizer ring

Fit the ring to the cone of the gear (top gear, or "third," "second" or "low" gear), and measure the clearance between the two at the peripheral teeth, as shown in Fig. 14-34. If the clearance has reached or exceeds the service limit, replacement the worn part.

Clearance between gear and ring	Standard	Service limit
	0.8~1.2 mm (0.03~0.05 in.)	0.5 mm (0.02 in.)



Fig. 14-34

Inspect the external cone (of the gear) and internal cone (of the ring) for abnormal wear. Be sure that the contact patterns on these surfaces indicate uniform full-face contact, and that the surfaces are free from any wavy wear. A badly worn member must be replaced.

Proper synchronizing action on gear shifting can be expected when the ring-to-gear clearance (Fig. 14-35) and the condition of cone surfaces, among other things, are satisfactory.

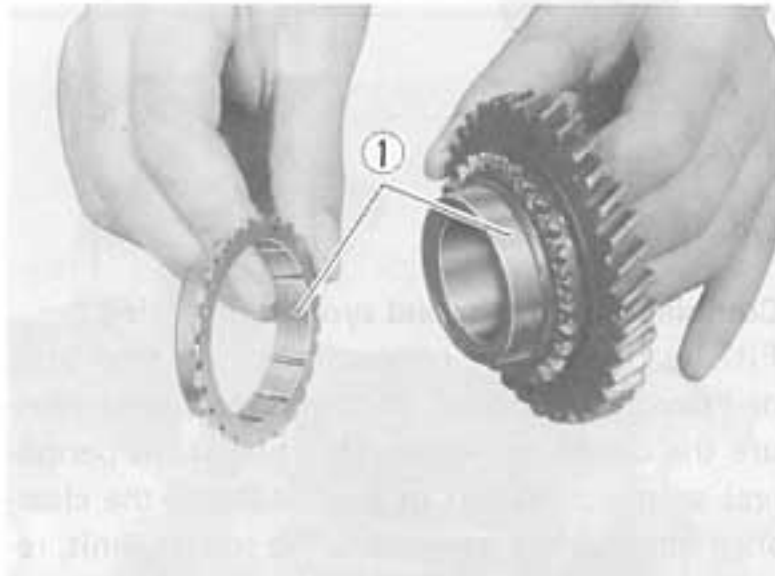


Fig. 14-35 ① Checking contacting surface.

#### Chamfered tooth ends of ring (external teeth) and sleeve (internal teeth)

Synchronizer ring and hub have three slots each, in which the keys are carried as backed by expanding springs, so that the hub and its two rings, one on each end, are capable of running together. Since the sleeve is engaged by its internal teeth with the hub, as if the two were splined together, the sleeve too runs with the hub and rings.

In meshing action, the sleeve is pushed (by the shifter fork) to one side, so that it slides axially on the hub, pushing the ring toward the cone surface of the gear. This push is transmitted by the three keys, which are lightly gripped by the sleeve.

By the friction between the gear cone and the ring cone (internal), the ring begins to rotate but is opposed by the hub because of the keys. In other words, the ring is at this time twisted, while the sleeve is advancing further to push the ring fully against the gear cone. Since the ring is unable to slide any further, the

sleeve lets go of the keys and rides over to the ring. At this moment, the initial contact between the chamfered ends of teeth of the ring and those of internal teeth of the sleeve occurs. This contact is such that the internal teeth of the sleeve align themselves to those of the ring. When the sleeve advances and slides into the ring, the ring will be rotating nearly with the speed of the gear, so that the sleeve is enabled smoothly to slide over into the clutch teeth of the gear.

The initial contactor mesh between sleeve and ring is determined by the widths of key and slot or, to say the same thing, the key clearance in the slot, and is prescribed to extend at least a third ( $1/3$ ) of the chamfer.

With the synchronizer properly assembled on the shaft, push in and twist each synchronizer to see if the one-third mesh occurs or not; if not, it means that the overall wear (which is the sum of the wears of slots, keys and chamfered tooth ends) is excessive and, in such a case, the entire synchronizer assembly must be replaced.

Mesh of chamfered tooth ends of synchronizer ring and hub	Contact extending about $1/3$ of chamfered face from apex
---	---

These two drawings illustrate the correct meshing of the chamfered tooth ends of the synchronizer ring and hub. The first drawing shows the meshing of the chamfered tooth ends of the synchronizer ring and hub. The second drawing shows the contact extending about  $1/3$  of the chamfered face from the apex.

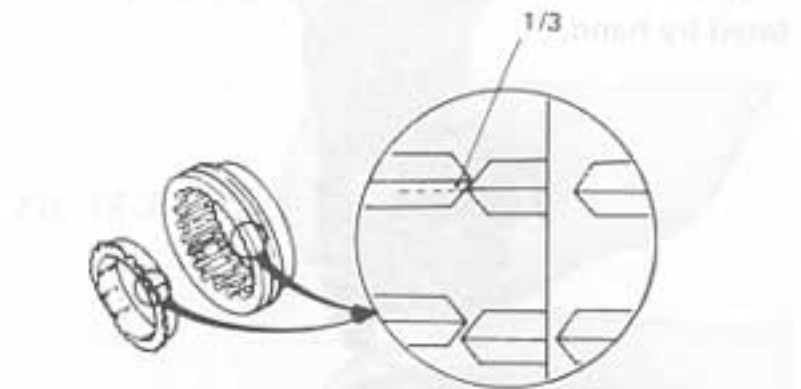


Fig. 14-36

### Synchronizer rings

Inspect each synchronizer ring for key slot wear by measuring the width of each slot. If the width reading exceeds the limit, replace the ring.

Key slot width	Standard	Service limit
Low gear	7.8 mm (0.31 in.)	8.1 mm (0.32 in.)
Second, third, top gear	9.6 mm (0.38 in.)	9.9 mm (0.39 in.)

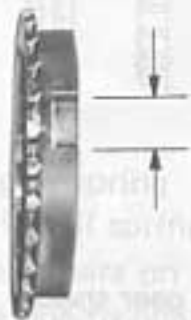


Fig. 14-37

### Fork shaft locating springs

Locating springs are used to arrest the three shifter fork shafts. If "gears slipping out of mesh" has been reported, check these springs for strength by measuring their free lengths, and replace them if their free lengths are less than the service limits.

Spring free length	Standard	Service limit
	19.5 mm (0.767 in.)	17.0 mm (0.669 in.)

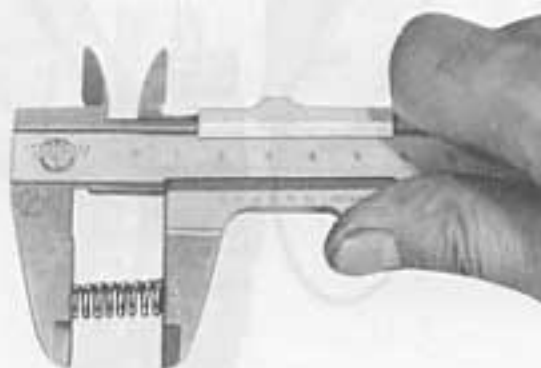


Fig. 14-38

### Gear backlash

Check the backlash of gears with a fuse wire element or dial gauge and replace if the backlash exceeds the specified service limit.

### Gear backlash

Gear	Standard	Service limit
Low & Second	0.10-0.15 mm (0.0039-0.0059 in.)	0.30 mm (0.0118 in.)
Third & Top	0.15-0.20 mm (0.0059-0.0078 in.)	0.30 mm (0.0118 in.)
Reverse	0.15-0.30 mm (0.0059-0.0118 in.)	0.40 mm (0.0157 in.)

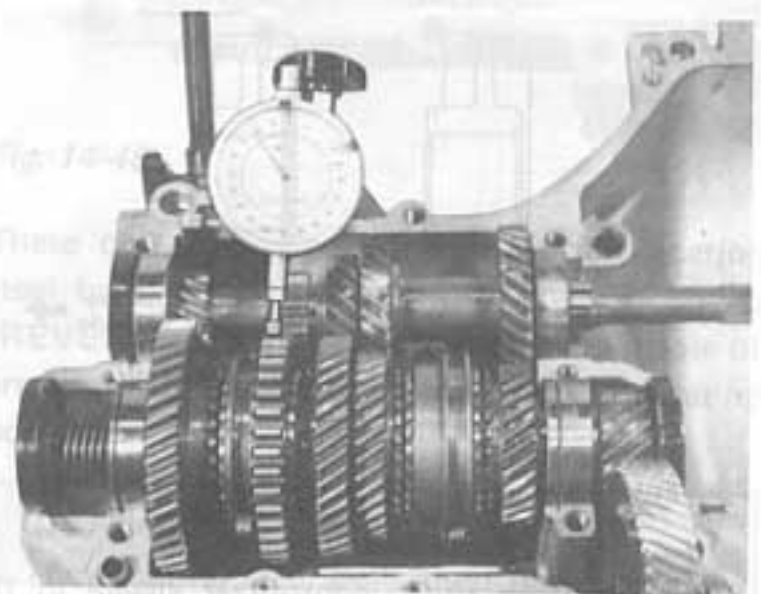


Fig. 14-39

### Shifter fork shafts

Check the groove of the shifter fork shaft which comes in contact with the locating spring ball, for wear.

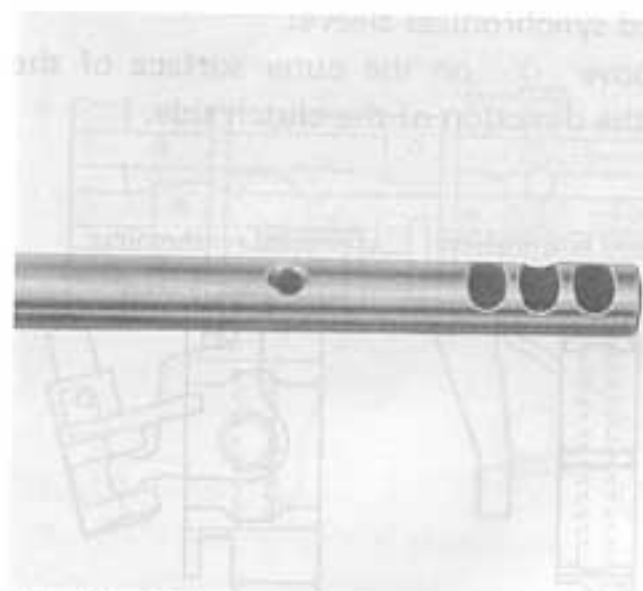


Fig. 14-40

## 14-7. Important Steps in Installation

### NOTE:

Wash all parts and apply gear oil to sliding surfaces.

### Synchronizer hub and synchronizer sleeve

When mounting the low-speed and high-speed synchronizer hubs on the countershaft, point the longer inner boss in the direction of the low gear side (opposite to the clutch).

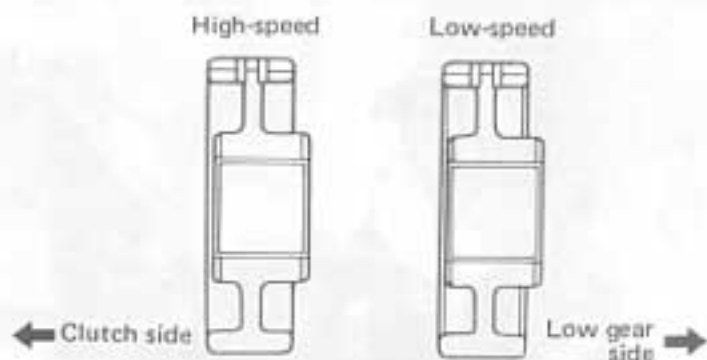


Fig. 14-41

When inserting the synchronizer sleeve in the synchronizer hub:

low-speed synchronizer sleeve:

point groove ① on the outer surface of the sleeve in the direction of the low gear side.

High-speed synchronizer sleeve:

point groove ② on the outer surface of the sleeve in the direction of the clutch side.

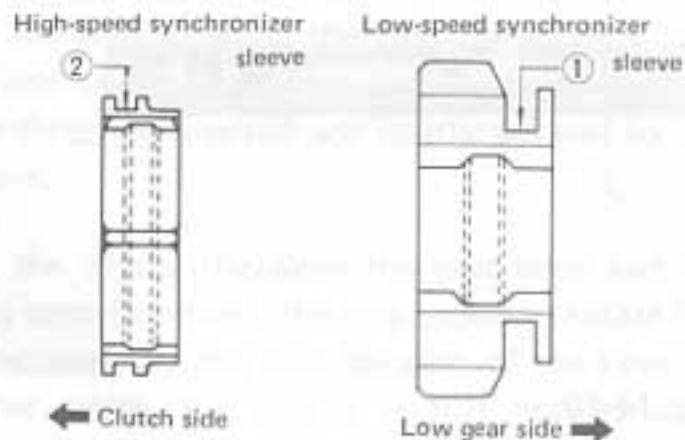


Fig. 14-42

### Synchronizer ring spring

Do not forget to install spring ① between the synchronizer ring of low gear side and synchronizer hub.

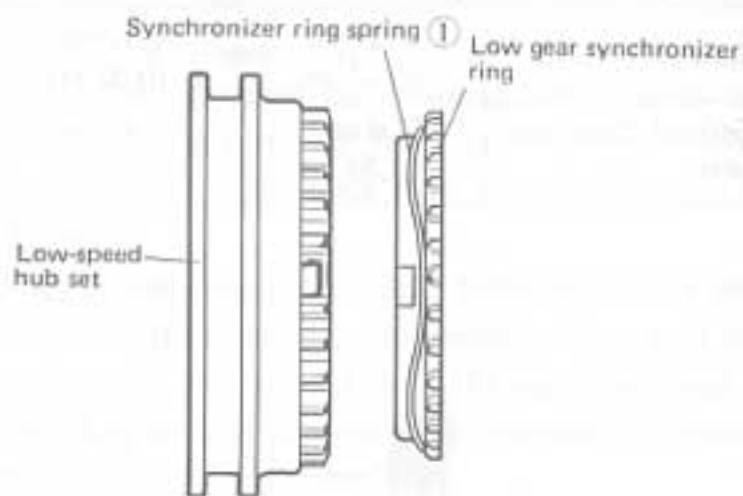


Fig. 14-43

### Second and third gear spacer

When assembling the second and third gear spacer, make sure that oil hole of counter shaft and oil grooves of second and third gear spacer match accurately.

(Refer to Page 14-4)

### Synchronizer spring

Do not deform or otherwise damage the synchronizer spring. To install the spring, insert one end of the spring in the spring setting hole ③ on the synchronizer hub, directing the 2 springs in opposition to each other so that the load is evenly applied to the synchronizer keys.

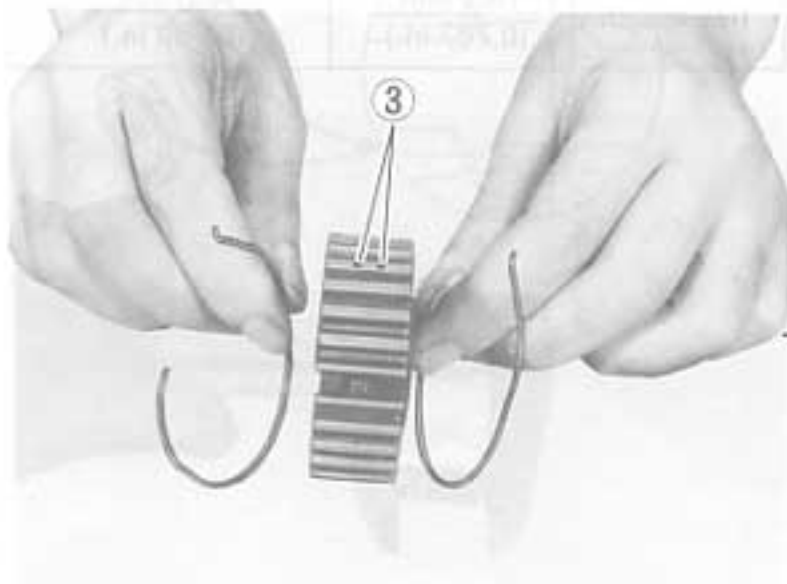


Fig. 14-44



After putting on each synchronizer, be sure that the three keys mounted on the hub fit snugly into the slots provided in the ring.

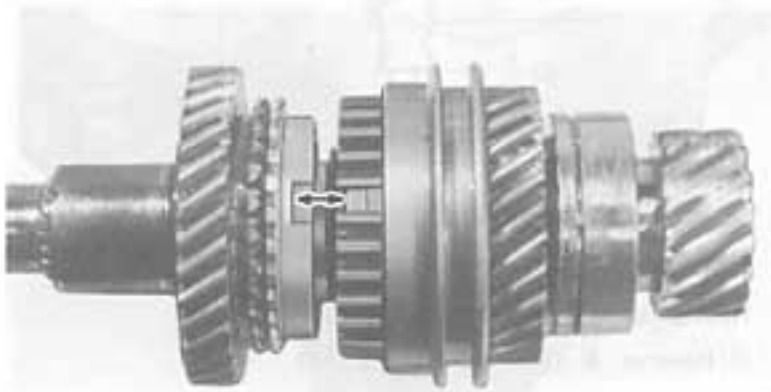


Fig. 14-45

#### 2ND, 3RD driven gear spring

Do not forget to install spring ① between the 2nd and 3rd driven gears on the counter shaft. This prevents noise due to play.



Fig. 14-46

#### Counter shaft bearing

To drive bearing into the counter shaft, use special tool ① (09913-80111).



Fig. 14-47

#### Shifter forks and shafts

When mounting the shifter fork on the shifter shaft, refer to Fig. 14-48 for the direction of the shifter forks.

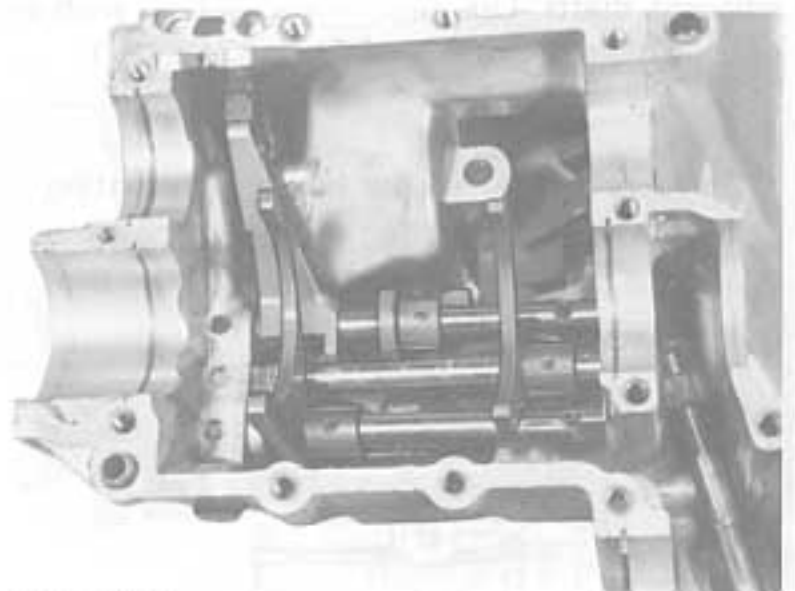


Fig. 14-48

These coil springs are for keeping the locating steel balls pushed down against the fork shafts (REVERSE, HIGH and LOW) for the purpose of arresting these shafts at respective operating positions.

#### CAUTION:

The locating steel balls used have an outside diameter of 7.9 mm  $\phi$  (0.311 in.  $\phi$ ).

Install the shifter shaft in the order of reverse shaft ①, high-speed shaft ② and low-speed shaft ③, as shown in Fig. 14-49.

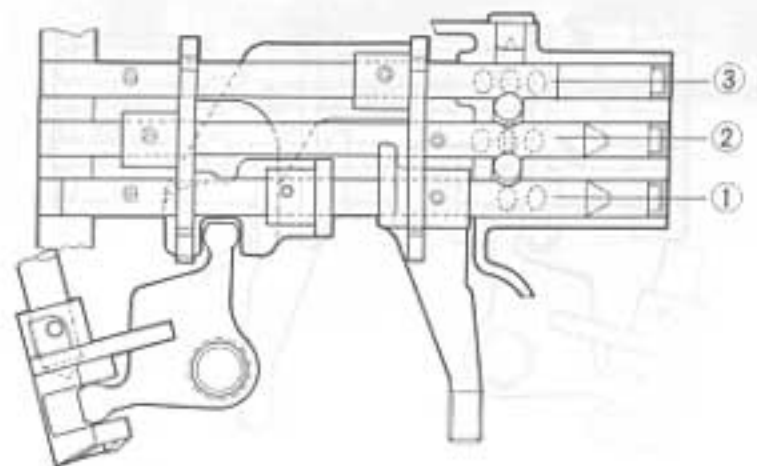


Fig. 14-49



Insert the interlock steel balls through hole ② next to the low-speed shifter fork shaft of the transmission case as illustrated below. Through this hole, insert one ball between each of the 2 adjacent shafts. Use inter lock steel balls with an outside diameter of 9.5 mm  $\phi$  (0.374 in.  $\phi$ ).

**NOTE:**

Be sure to put in the pin for preventing two shafts from getting shifted at the same time. This pin ① goes into the hole provided in the high-speed shaft.

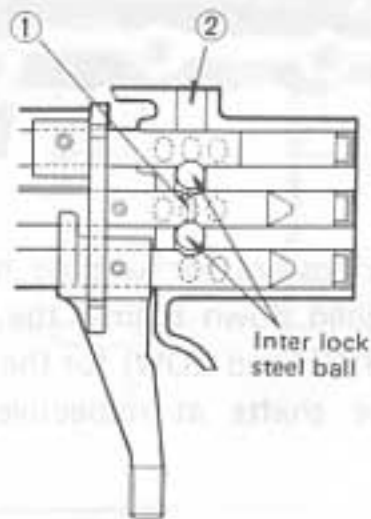


Fig. 14-50

**Gear shifter shaft stopper pin**

Drive the shifter shaft stopper pins (low-speed, high-speed and reverse) into the shifter shaft so that dimension H is obtained, as illustrated in Fig. 14-52.

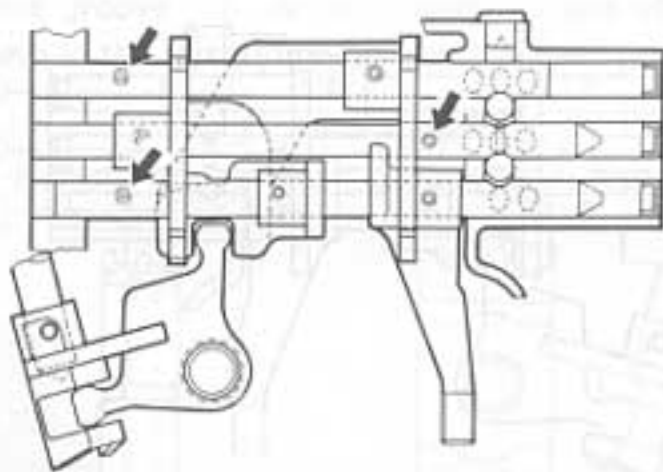
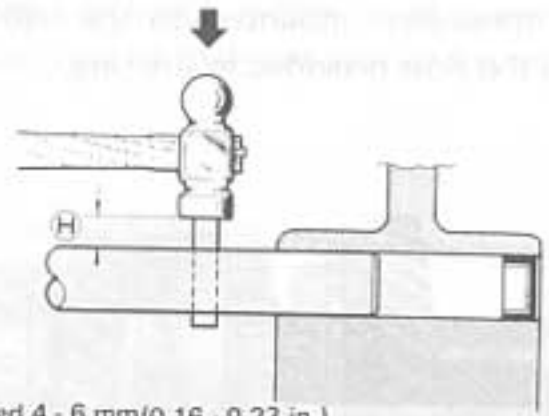


Fig. 14-51



H: Low-speed 4 - 6 mm (0.16 - 0.23 in.)

H: High-speed 0 mm (0 in.)

H: Reverse 4 - 6 mm (0.16 - 0.23 in.)

Fig. 14-52

**Reverse gear shifter lever**

When installing the reverse gear shifter lever, adjust dimension "D" as illustrated below to 5 mm (0.197 in.) with the gear shifter lever bolt ④. This is necessary to keep the clearance between the lever and second gear on the input shaft to more than 2 mm (0.078 in.) when shifting the gear into reverse.

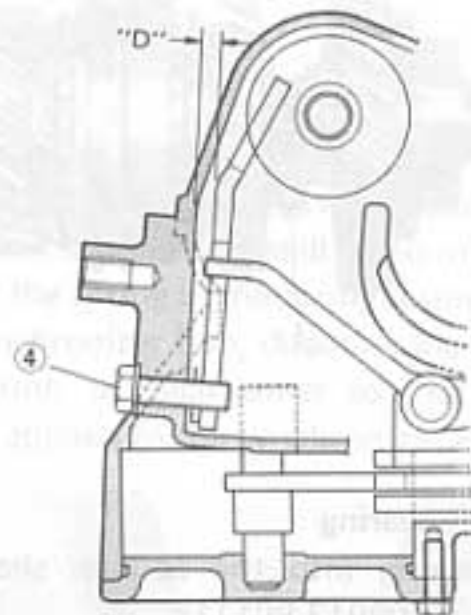


Fig. 14-53

### Gear shifter fork shaft plugs

Before installing the gear shifter fork shaft plugs, apply SUZUKI BOND NO.4 (99000-31030) to the outer surface of the plugs.

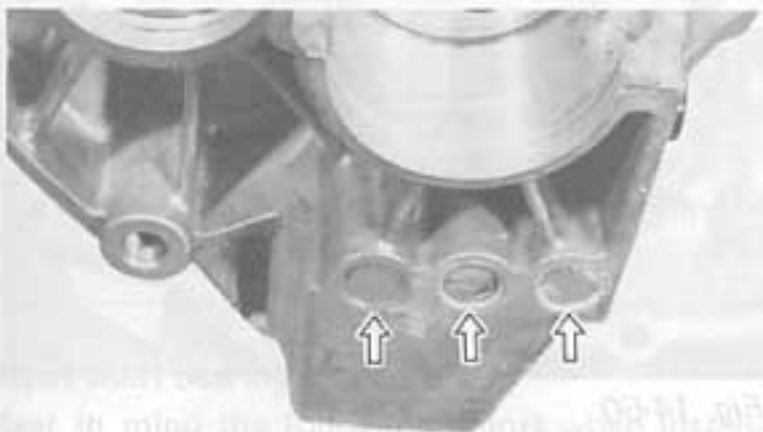


Fig. 14-54

### Gear shifter interlock plug

Apply SUZUKI BOND NO.4 (99000-31030) to the gear shifter interlock plug and insert it into the transmission case.

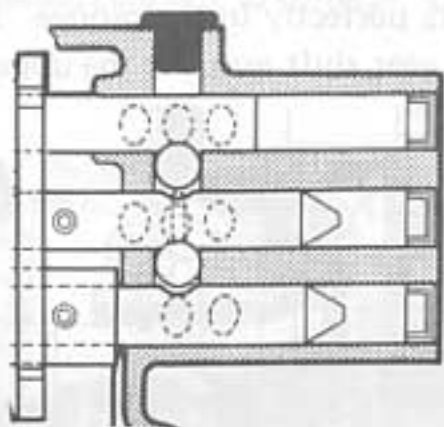


Fig. 14-55

### C ring

Do not forget to fit the 2 "C" rings on counter shaft bearing and input shaft C ring in the transmission case.

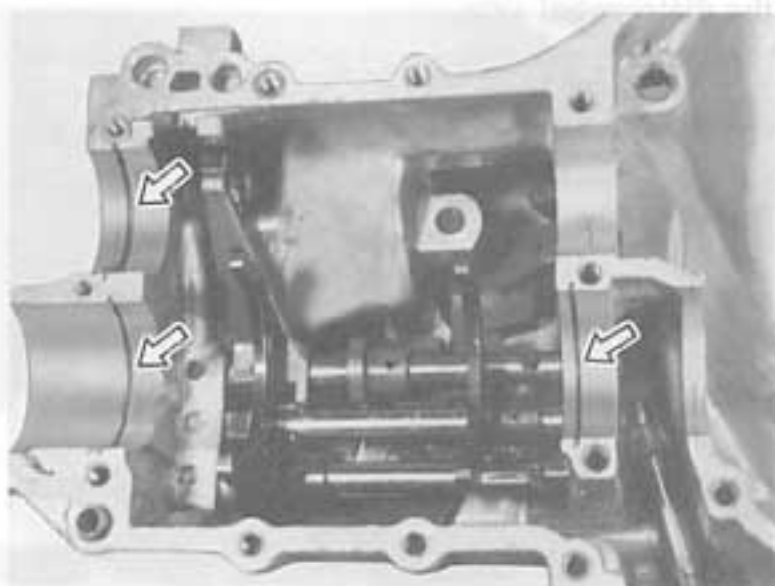


Fig. 14-56

### Counter shaft

Install the countershaft in the lower case with the gears on the countershaft in neutral (shifter fork shafts must also be in neutral), fitting the shifter fork in the groove of the sleeve.

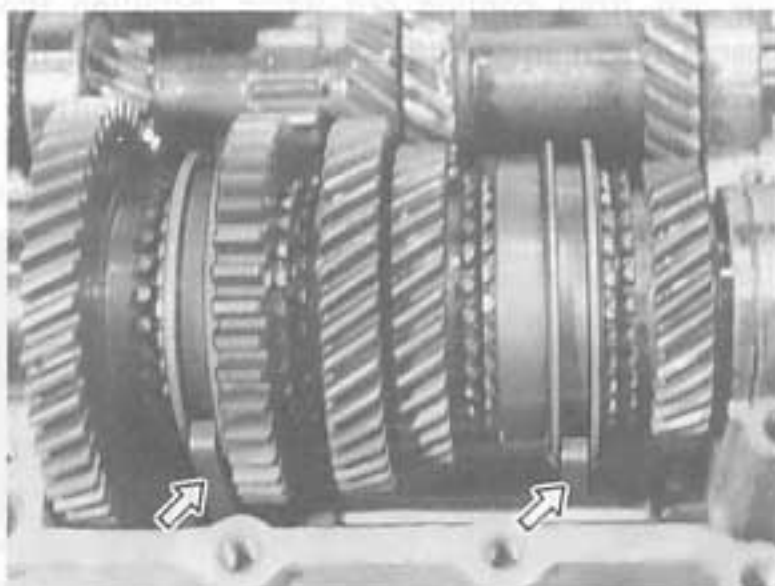


Fig. 14-57

### Counter shaft bearing plug

Install the countershaft bearing plug, directing the rib ① (flange) of the plug outside the case, toward the joint of the upper and lower cases on the differential side.

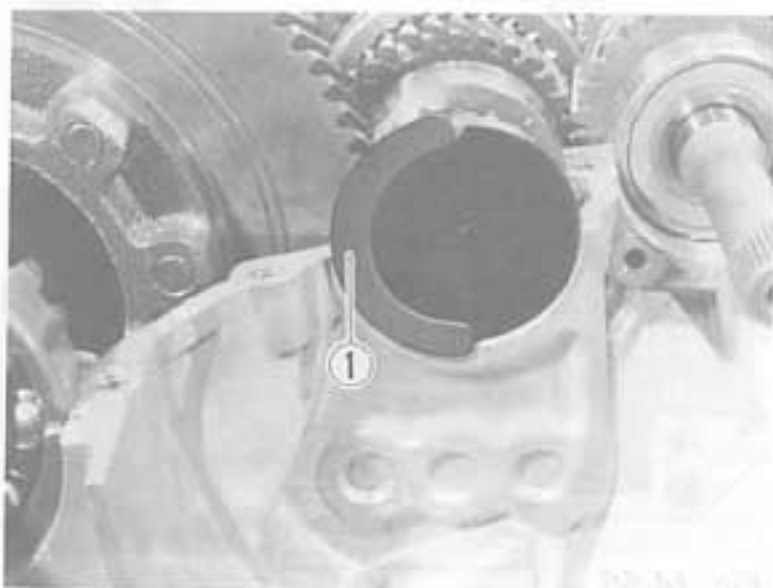


Fig. 14-58

### Reverse gear shaft pin

Do not forget to install the reverse gear shaft pin. After installation, apply grease to the hole into which the pin has been inserted to prevent the pin from coming out when installing the gear. Do not install the reverse idle gear in the wrong direction.

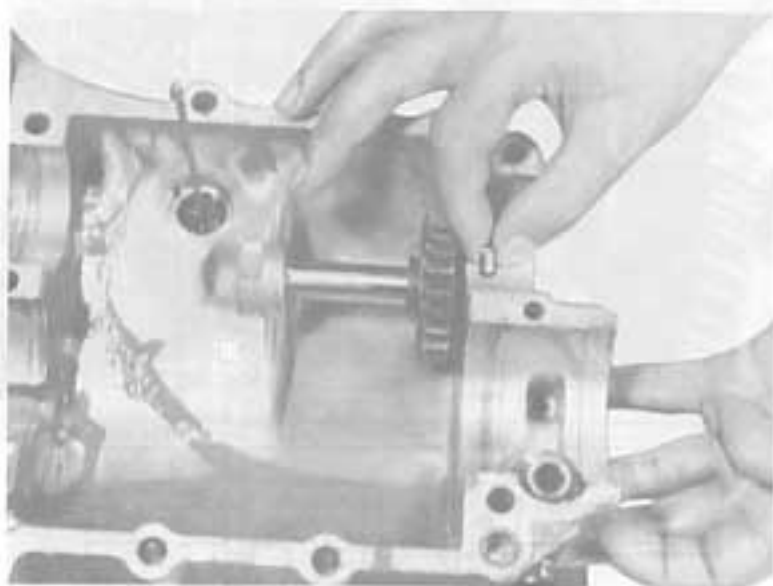


Fig. 14-59



Fig. 14-60

### Putting together upper and lower cases

Clean the joint faces, removing any foreign matters adhering to these faces, and then apply the liquid sealing compound (SUZUKI Bond No. 4, 99000-31030) to the joint faces, coating each face uniformly with the compound and, a few minutes after this application, match the two cases together.

### Upper case

Move the idle gear to right and left so that the idle gear fits perfectly in the groove ② of the reverse idle gear shift arm. Fit the upper case on the lower case.

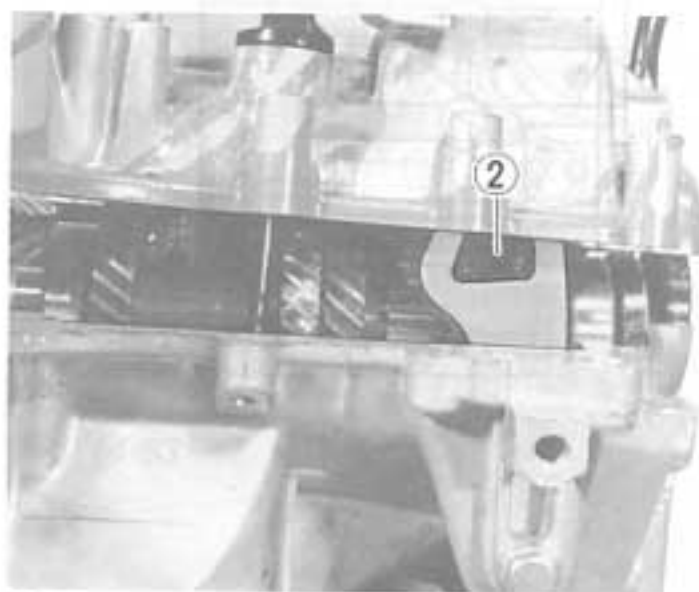


Fig. 14-61

**CAUTION:**

Do not forget to install the snap rings (right and left) on the differential side gear spline.

**NOTES:**

- Refer to the item on clutch (group 12) for clutch installation procedure.
- Refer to the next page when installing the differential gears.

**Input shaft bearing retainer**

Bear in mind the following points when installing the input shaft bearing retainer.

- Apply SUZUKI SUPER GREASE "A" (99000-25010) to the oil seal lip.
- Install "O" ring ③ in the groove of the retainer and then apply SUZUKI BOND(NO.4) (99000-31030) to a part of the retainer that is lined up with the joint of upper and lower transmission cases.
- Match the upper and lower transmission cases together without tightening the bolts and insert the retainer into the transmission case taking care not to damage "O" ring ③.

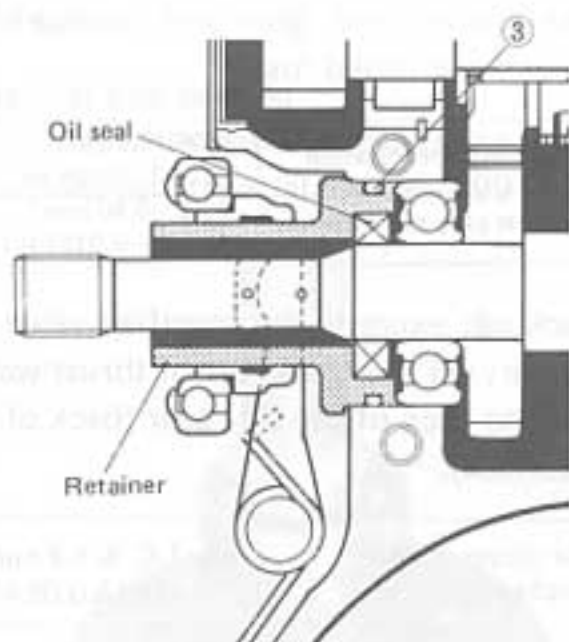


Fig. 14-62

**Oil drain plug**

Remove the oil drain plug and apply SUZUKI BOND NO.4 (99000-31030) to the screw part of the plug before reassembling.

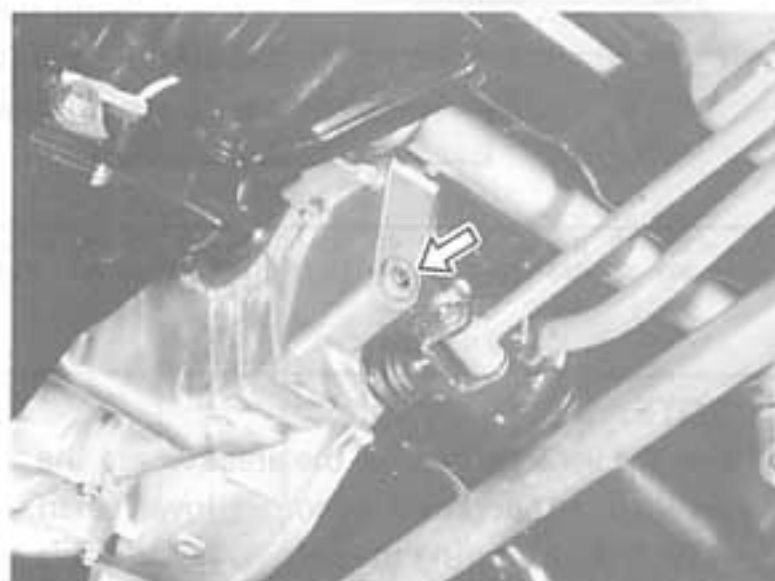


Fig. 14-63 Oil drain plug

**Oil filler plug and level gauge**

Check the oil level according to the following procedures.

- 1) Take out the oil level gauge from the transmission case and wipe off the oil.
- 2) Bring face A of the oil level gauge to contact face B of the transmission case and check the oil level indicated by the oil on the gauge.

The oil level must be somewhere between FULL level line and LOW level line on the gauge.

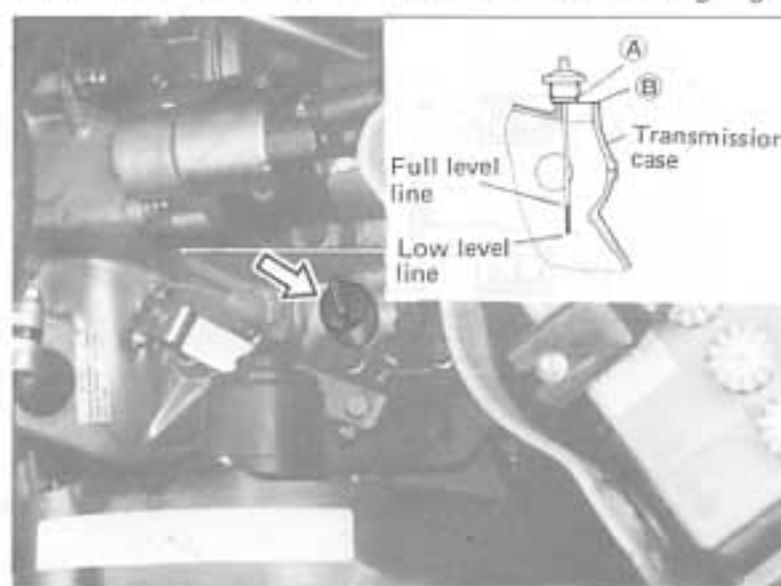


Fig. 14-64

**Transmission oil**

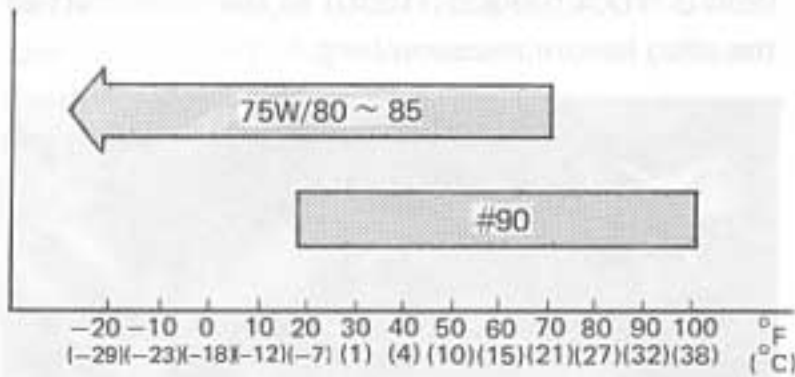
The oil capacity of the transmission and the oil specification are as follows:

Oil capacity	2.0 litres (4.2/3.5 US/Imp.pt.)
Oil specification	Gear oil, SAE #90



## GEAR OIL

Recommended SAE viscosity number



### NOTE:

For the vehicles used in the areas where the ambient temperature becomes lower than  $-15^{\circ}\text{C}$  ( $5^{\circ}\text{F}$ ) during the coldest season, it is recommended that oil be changed with SAE 80W or 75W/80-85 oil during the services such as a periodic maintenance.

## 14-8. Maintenance Services (Differential)

### Differential case bolts

Check the differential case bolts for looseness and retighten if loose.

Differential case bolt	80 - 100 N.m 8.0 - 10.0 kg-m (58.0 - 72.0 lb-ft)
------------------------	--

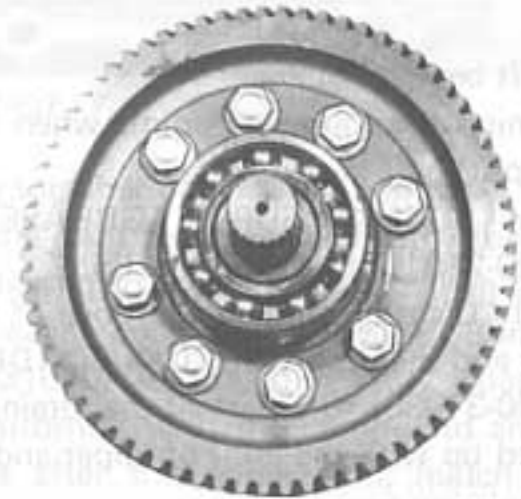


Fig. 14-65

### Differential side pinion & gear

Measure the backlash of the side pinion and side gear. To measure backlash, insert a thin fuse between the pinion and gear and measure the thickness of the crushed fuse.

Side gear backlash specification	0.05 - 0.10 mm (0.002 - 0.004 in)
Side gear thrust play specification	0.15 - 0.40 mm (0.006 - 0.0157 in)

If the backlash exceeds the specified value, adjust it by varying the thickness of thrust washer

① at the back of the side gear (back of the toothed surface).

Available thrust washer sizes (thickness)	0.8, 1.0, & 1.2 mm (0.03, 0.04 & 0.05 in.)
---	---



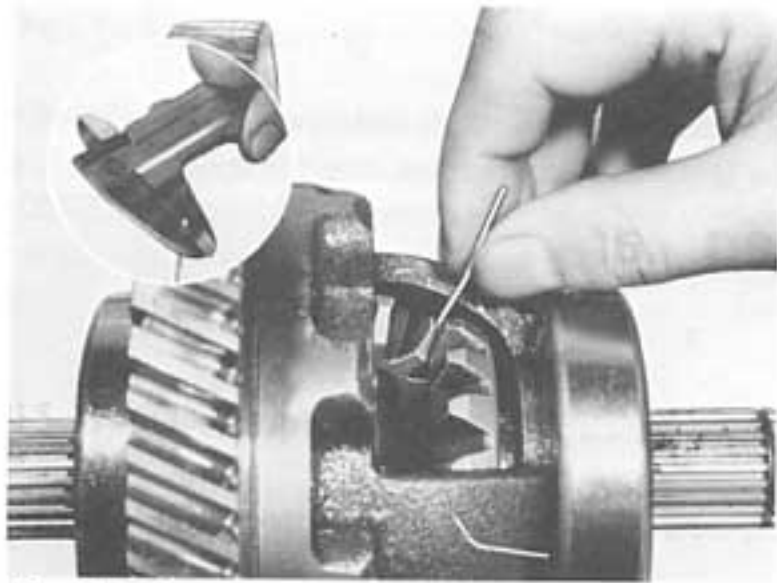


Fig. 14-66

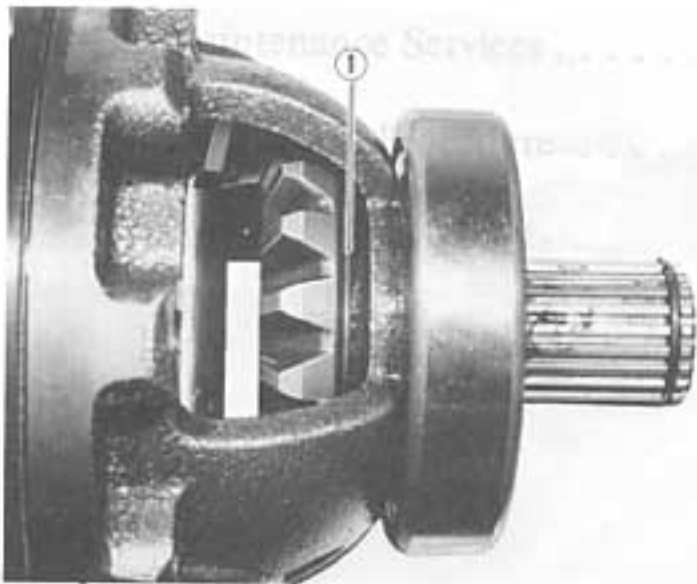


Fig. 14-67

#### Differential side bearing

Press-fit the differential side bearing with a hydraulic press using special tool (A) (09913-75810).

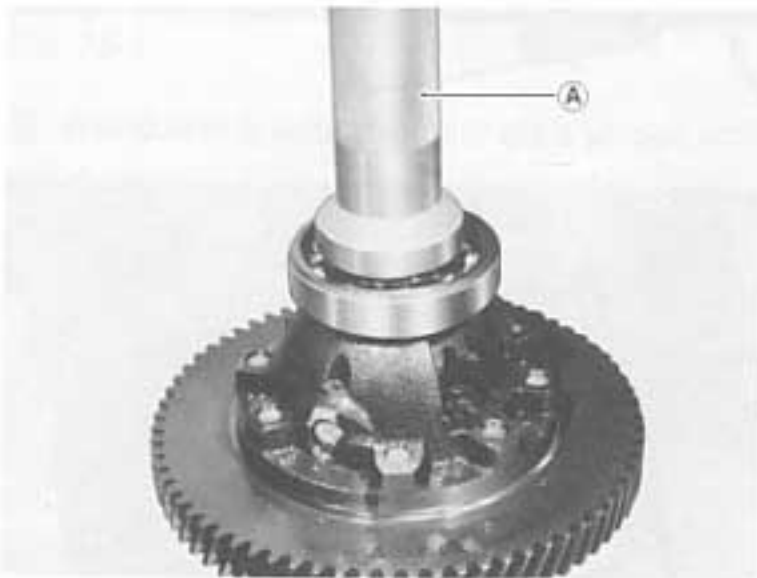


Fig. 14-68

## 14-9. Important Steps in Installation (Differential)

### Differential Side bearings

Install the differential side bearings in the correct direction.

Direct the seal side ① of the bearing (iron plate side) inward (transmission oil side).

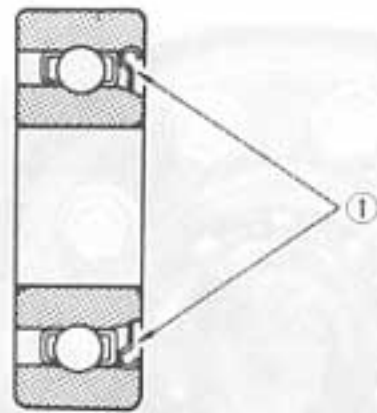


Fig. 14-69

### Differential Side oil Seals

Apply grease to the lip of the differential side oil seal and install with spring ② of the oil seal positioned inside (transmission oil side).

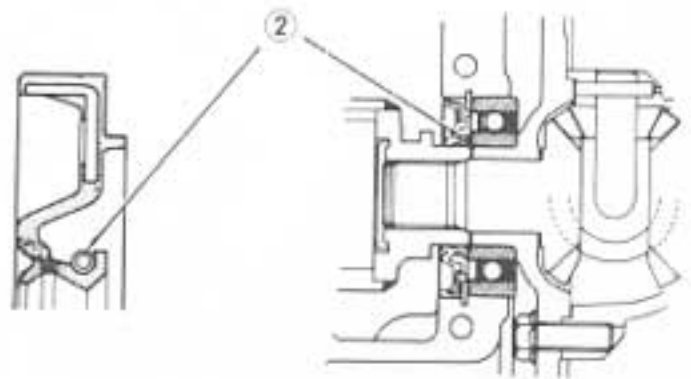


Fig. 14-70

### Differential case bolts

Special bolts are used for the differential case because of the high torsional load. Never use bolts other than the specified ones.

### Tightening torque

Differential case bolt	80 - 100 N.m 8.0 - 10.0 kg-m (58.0 - 72.0 lb-ft)
------------------------	--



Fig. 14-71



## 15-1. Description

The drive shaft joint is a constant velocity joint (C.V. joint) which slides in the axial direction. The joint is composed of an outer race, cage, inner race and balls. In the turning direction, the joint rotates in the same way as a ball bearing. The 6 balls lock rotation completely and transmit drive. In addition, the SS40 is also characterized by a function that the shaft can slide through the balls in the grooves of the outer race in the extension/contraction direction of the drive shaft.

### Major characteristics

1. Being a complete constant velocity joint, the joint ensures smooth rotation of drive shaft.
2. Small drive shaft sliding resistance reduces the effect of engine vibration on the chassis.
3. Excellent durability.

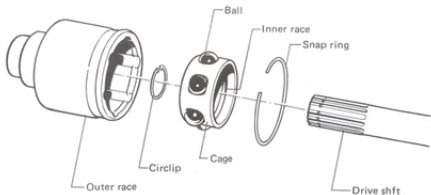
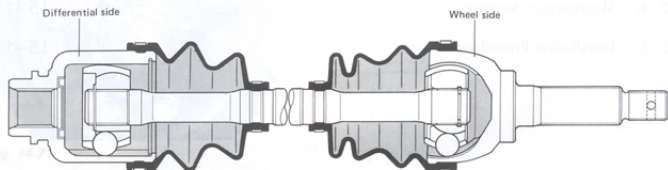


Fig. 15-1

## 15-2. Dismounting

- 1) Lift the front end of the machine by jacking, and support it with safety stands.



Fig. 15-2

- 2) Drain out oil in the transmission.

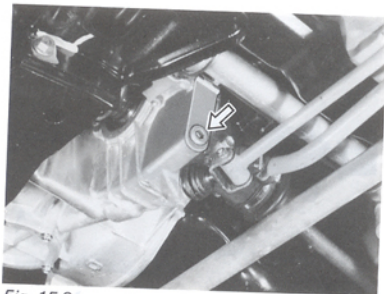


Fig. 15-3

- 3) Remove hub nuts and take off a wheel.

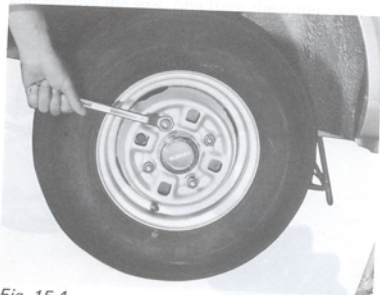


Fig. 15-4

- 4) Draw the drive shaft out of the snap ring fitted on the spline of the differential side gear.

### NOTE:

At this stage, the drive shaft cannot be taken out from the side gear.

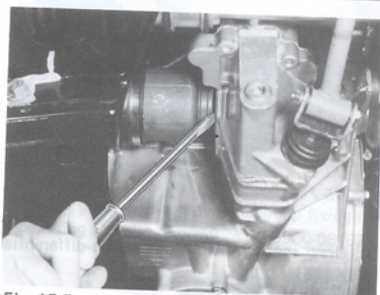


Fig. 15-5

- 5) Remove the drive shaft castle nut.
- 6) Detach the tie rod end from the steering knuckle by using special tool A (09913-65210).

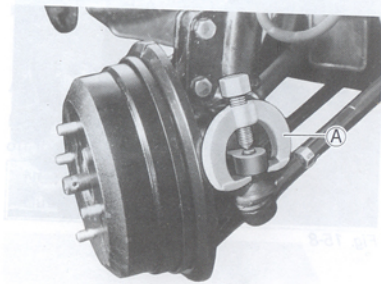


Fig. 15-6

- 7) Detach the front suspension arm ball joint stud from the steering knuckle.

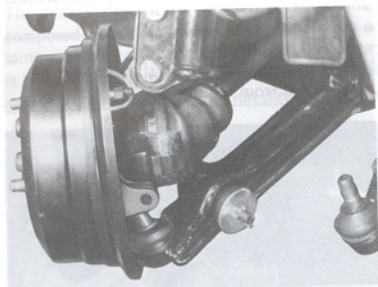


Fig. 15-7

- 8) Draw the drive shaft out of the differential side gear spline.

**CAUTION:**

At this time, be careful not to damage the brake flexible hose.

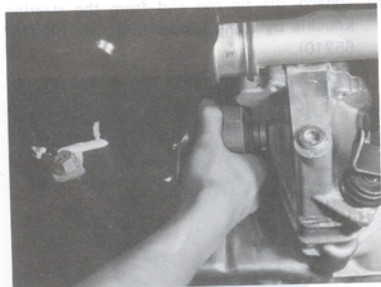


Fig. 15-8

- 9) After inserting the suspension arm ball joint stud to steering knuckle, fit nut ① on the drive shaft and tap the shaft from the outside to the inside with a plastic hammer.

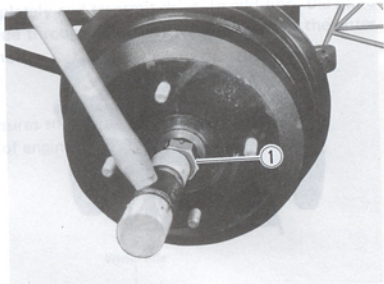


Fig. 15-9



### 15-3. Disassembly

Wipe the outer surface of the drive shaft with a cloth and disassembly in the following manner.

- 1) Jack up the car body and confirm that the drive shaft is free from play in the rotational direction and rotates smoothly.

When any damage is found, check the following points before replacement).

- Inspect contact condition of parts (wears) and replace if worn remarkably or damaged.
- Check each part for chips and cracks.

Fig. 15-10

Remove the boot band.

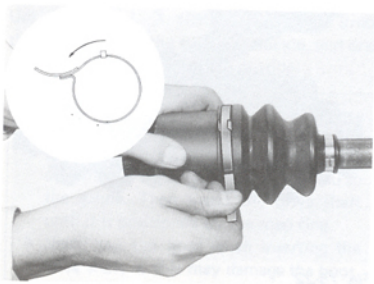


Fig. 15-11

Slide the boot toward the center of the shaft and remove the snap ring from the outer race.

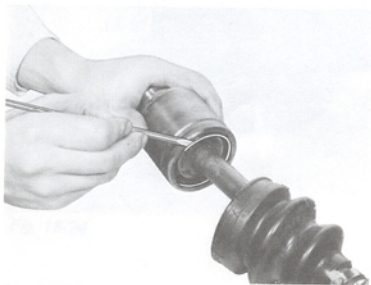


Fig. 15-12

Take the shaft off the outer race.

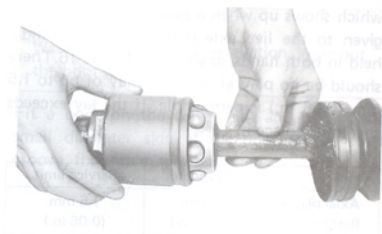


Fig. 15-13

Wipe off grease and remove the circlip fixing the cage, using a circlip remover (A) (09900-06107).

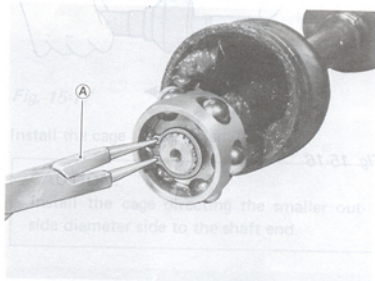


Fig. 15-14

Draw the cage and boot (inside or outside boot) off the shaft.

**NOTE:**

Outside joint is not removable.

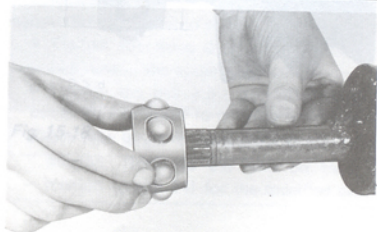


Fig. 15-15

### Barfield joint inspection

To be checked on this joint is its axial play, which shows up when a push-and-pull motion is given to the live axle shaft and wheel spindle held in both hands, as shown in Fig.15-16. There should be no play at all but a play of up to 1.5 mm (0.06 in.) is permissible. If the lay exceeds the limit replace it.

	Standard	Service limit
Axial play in Barfield joint	0 mm (no play)	1.5 mm (0.06 in.)

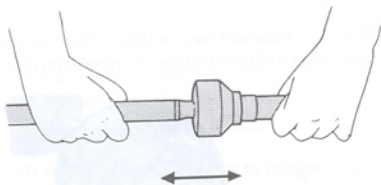


Fig. 15-16

#### 15-4. Maintenance Services

- 1) Check the boots for breakage.
- 2) Inspect for abnormal noise at start or while running.
- 3) Jack up the car body and confirm that the drive shaft is free from play in the rotational direction and rotates smoothly.

When any defect is found, check the following points.

- Inspect the boots for breakage and replace if broken (inspect following points before replacement).
- Inspect contact condition of parts (wear) and replace if worn remarkably or damaged.
- Check each part for chips and cracks.
- Check the circlip and snap ring for deformation or breakage and replace when defective.

#### 15-5. Installation Procedure

##### CAUTION:

Wash all parts before installation. Wipe out the boot with a cloth.

Fit a boot on the drive shaft and, fitting the small diameter side of the boot to the shaft groove, fix with a boot band.

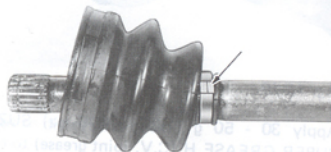


Fig. 15-17

Install the cage ① on the shaft.

##### CAUTION:

Install the cage directing the smaller outside diameter side to the shaft end.

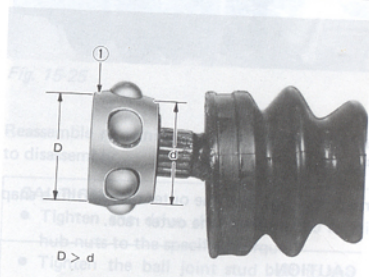


Fig. 15-18

Do not forget to fit a circlip when fitting the cage.

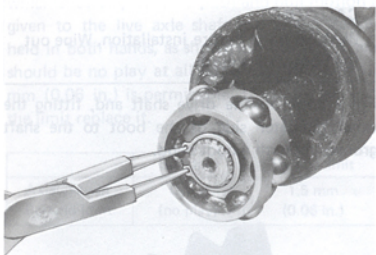


Fig. 15-19

Apply 30 - 50 g (1.06 - 1.76 oz) SUZUKI SUPER GREASE H (C.V. joint grease) to entire surface of the cage.

SUZUKI SUPER GREASE H  
(C.V. joint grease) (99000 - 25120)

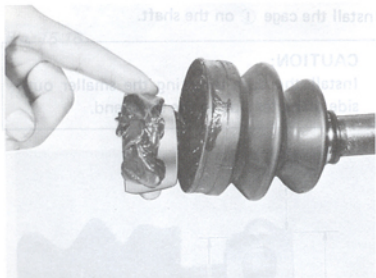


Fig. 15-20

Insert the cage into the outer race and fit a snap ring in the groove of the outer race.

**CAUTION:**

Locate the opening of the snap ring ① so that the opening is not lined up with a ball.

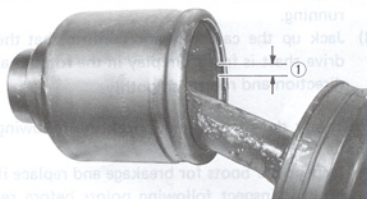


Fig. 15-21

Apply 30 - 40 g (1.06 - 1.41 oz) SUZUKI SUPER GREASE H (99000 - 25120) to the inside of the outer race, and fit the boot on the outer race.

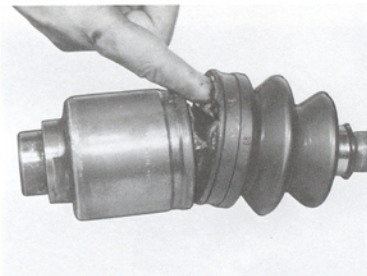


Fig. 15-22

After fitting the boot, insert a driver into the boot on the outer race side and allow air to enter the boot so that the air pressure in the boot becomes the same as the atmospheric pressure at the positions indicated in Fig. 15-23.



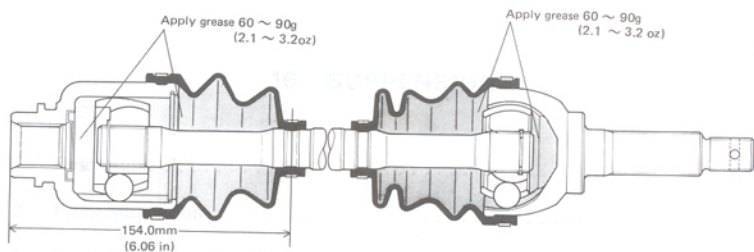


Fig. 15-23

Fix the boot to the outer race with a boot band, taking care not to distort the boot.

Use special tool **A** (09922 - 55121) to install the drive shaft in the steering knuckle, and draw the drive shaft from inside to outside.

**CAUTION:**

- Before inserting the drive shaft into the spline of the differential side gear, make certain that a snap ring has been fitted to the spline. Then insert the drive shaft until it is positioned by the snap ring.
- Never tap the boot when inserting the drive shaft as this may damage the boot.

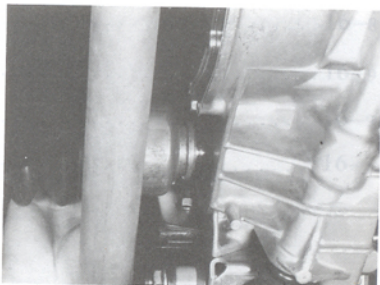


Fig. 15-25

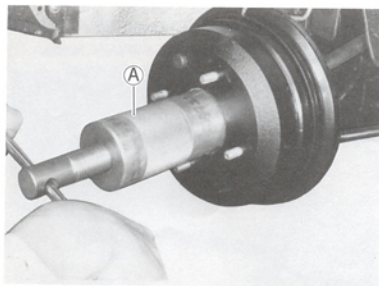


Fig. 15-24

Reassemble remaining parts in the reverse order to disassembly.

**CAUTION:**

- Tighten the drive shaft castle nut and hub nuts to the specified torque.
- Tighten the ball joint stud bolt to the specified torque.
- Do not forget to lubricate the transmission. Refer to the item on transmission (group 14) for the specified oil.



### 16-1. Description

Front suspension is Macpherson type independent suspension system as shown in the Fig. 16-1, and consists of coil springs, front suspension struts, steering knuckles, stabilizer bar, and front suspension arms. In this type of construction, shock applied to wheels is distributed through steering knuckles from front suspension struts, coil springs, to front suspension arms, and are absorbed. Rear suspension is of dead axle type using leaf springs, and consists of leaf springs, bump stoppers, and shock absorbers.

### 16-2. Front Suspension

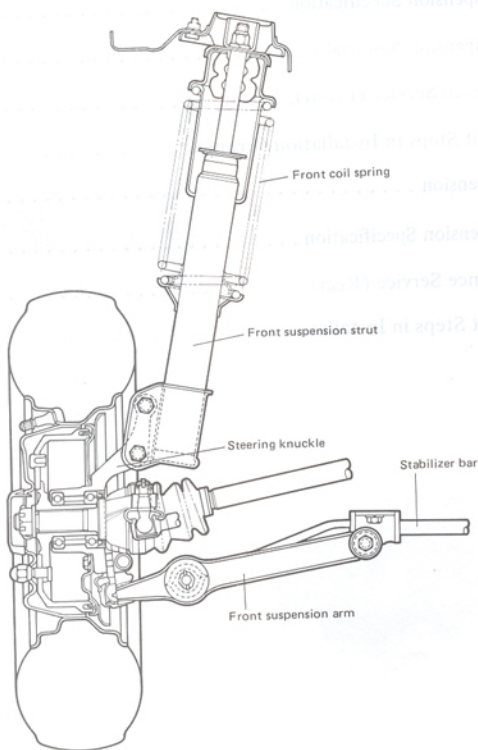


Fig. 16-1 Front suspension

### 16-3. Front Suspension Specification

#### Front suspension struts

Attenuation force (extending side)	40 kg (88 lb)
Attenuation force (contracting side)	20 kg (44 lb)
Stroke	135 mm (5.3 in)

#### NOTE:

The attenuation force of the shock absorber is for a piston speed of 0.3 m/sec (1.0 ft/sec).

#### Front coil springs

Spring rate	1.48 kg/mm (83 lb/in.)
Free length	342 mm (13.5 in.)

### 16-4. Front Suspension Removal

#### Front coil spring

- 1) Lift the front end of the machine by jacking, and support it with safety stands.



Fig. 16-2

- 2) Remove hub nuts and take off a wheel.

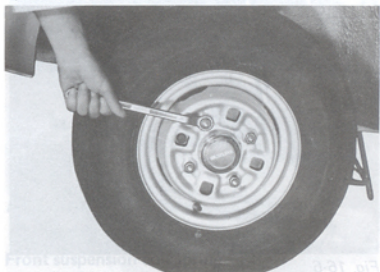


Fig. 16-3

- 3) Disconnect the brake flexible hose and brake pipe, and remove the flexible hose from the suspension strut.

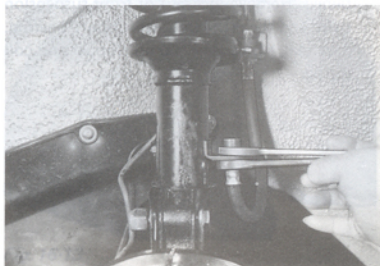


Fig. 16-4

- 4) Remove the 2 bolts securing the strut to the steering knuckle.

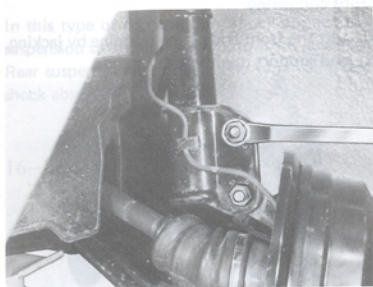


Fig. 16-5

- 5) Remove the strut by loosening the strut support nuts.

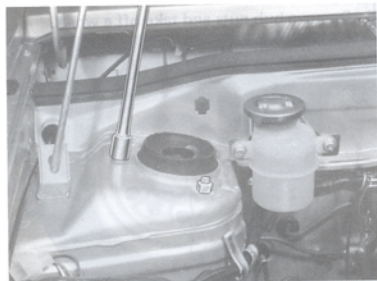


Fig. 16-6

- 6) Compress coil spring using special tool, front coil spring tool **A** (09943-25810) until play between coil spring and spring seat is obtained. Remove lock nut of front suspension strut, and then remove strut support, bearing, dust seal, rubber seat, bump stopper and coil spring.

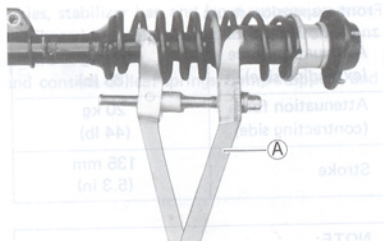


Fig. 16-7

#### Tie rod end

Detach the tie rod end from the steering knuckle by using special tool **A** (09913-65210).

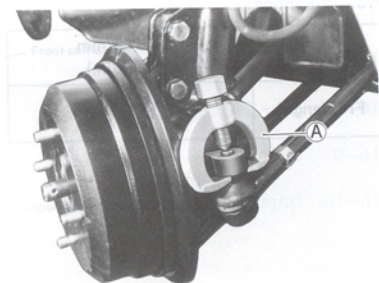


Fig. 16-8

#### Front wheel hub

- 1) Lift the front end of the machine by jacking, and support it with safety stands.
- 2) Remove hub nuts and take off a wheel.
- 3) Remove the drive shaft castle nut **1**.

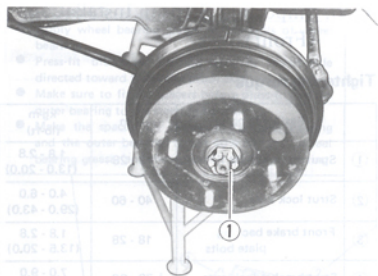


Fig. 16-9

- 4) Remove the brake drum by using two 6 mm bolts (2).

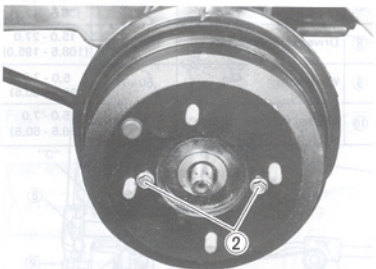


Fig. 16-10

- 5) Install the special tool B (09943-17910) by utilizing the hub bolts. Using the sliding hammer C (09942-15510), draw out the wheel hub.

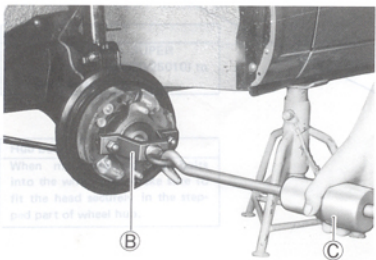


Fig. 16-11

## 16-5. Maintenance Service (Front)

### Front suspension strut

Since the front suspension strut services as both the oil damper and steering king pin, this unit should be checked in respect of these two functions. Following shows the check items.

- Check for the roadability of the vehicle and rattling sound while driving on rough roads.
- Push the body hard, and if it jolts 3-4 times the damping force of the shock absorber is considered to have decreased.
- Check the absorber for oil leakage. If the absorber is found faulty, replace it as a assembling unit, because it can not be dis-assembled.



Fig. 16-12

### Front suspension coil spring

Front coil spring itself is almost trouble free, but when it is found weak after a long time of use, it should be replaced.

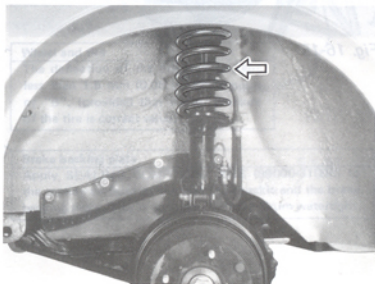


Fig. 16-13



## Tie rod end ball joint and suspension lower arm ball joint

- 1) Check the boots for breakage and replace if broken.

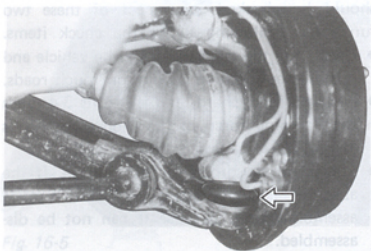


Fig. 16-14

- 2) Check each ball joint for wear. If it is worn and play is found between the ball joint stud and the bush in the joint case, replace defective parts.



Fig. 16-15

## 16-6. Important Steps in Installation (Front)

### Tightening torque

	Fastening parts	N-m	kg-m (lb-ft)
①	Strut support nuts	18 - 28	1.8 - 2.8 (13.0 - 20.0)
②	Strut lock nuts	40 - 60	4.0 - 6.0 (29.0 - 43.0)
③	Front brake backing plate bolts	18 - 28	1.8 - 2.8 (13.5 - 20.0)
④	Strut bracket lock nuts	70 - 90	7.0 - 9.0 (51.0 - 65.0)
⑤	Stabilizer bar mount bolts	30 - 55	3.0 - 5.5 (22.0 - 39.5)
⑥	Stabilizer bar castle nuts	40 - 90	4.0 - 9.0 (29.0 - 65.0)
⑦	Ball joint stud bolts	50 - 65	5.0 - 6.5 (36.5 - 47.0)
⑧	Drive shaft castle nuts	150 - 270	15.0 - 27.0 (108.5 - 195.0)
⑨	Wheel nuts	50 - 70	5.0 - 7.0 (36.5 - 50.5)
⑩	Lower arm bolts	50 - 70	5.0 - 7.0 (36.5 - 50.5)



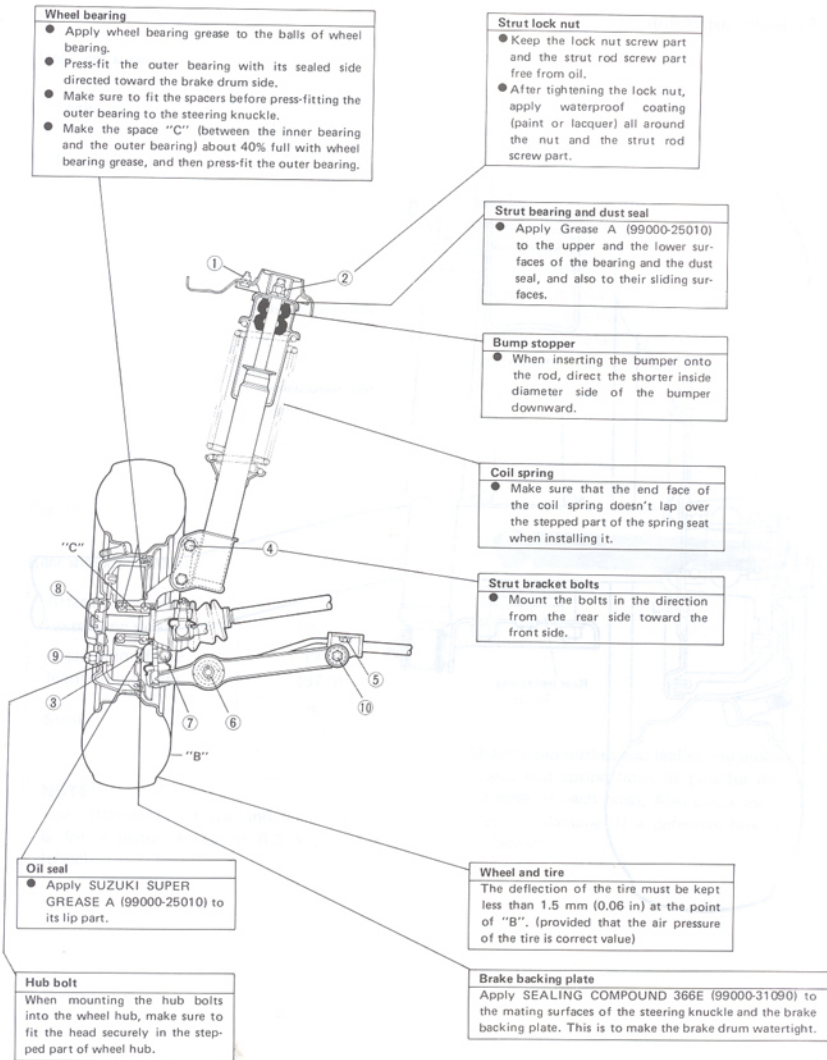


Fig. 16-16

## 16-7. Rear Suspension

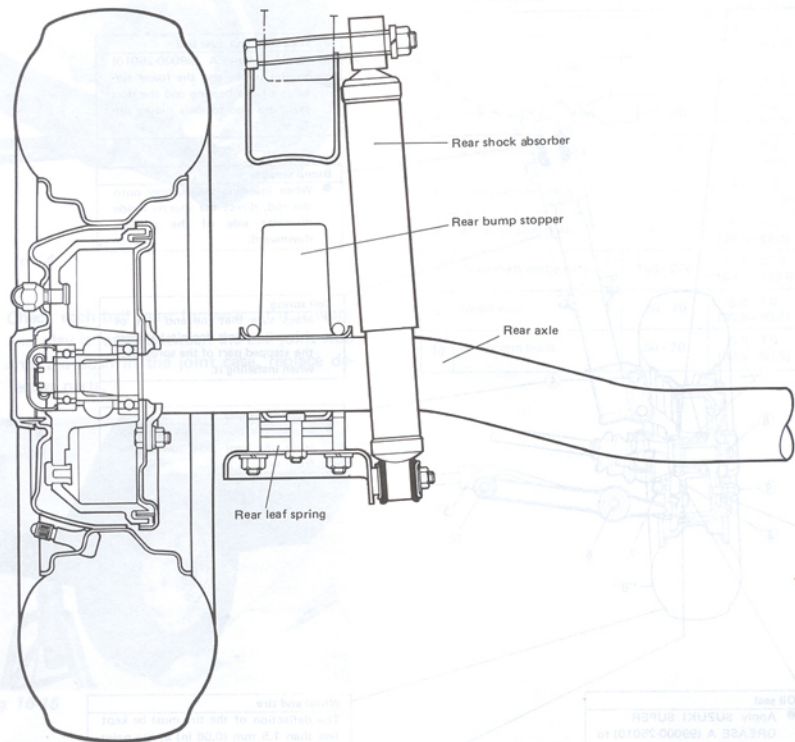


Fig. 16-17

## 16-8. Rear Suspension Specification

### Rear leaf springs

Spring rate	2.6 kg/mm (145.6 lb/in.)
Free height H	156 mm (6.1 in)



Fig. 16-18

### Rear shock absorbers

Attenuation force (extending side)	30 kg (66 lb)
Attenuation force (contracting side)	17 kg (37 lb)
Stroke	175 mm (6.9 in)

#### NOTE:

The attenuation force indicated above is for a piston speed of 0.3 m/sec (1.0 ft/sec).

## 16-9. Maintenance Service (Rear)

### Rear leaf springs

If the chassis is found lower than the normal position owing to the excessive fatigue of the leaf spring, check the height of the spring from the center bolt. If the fatigue of the spring is excessive, replace the spring.  
(Refer to Fig. 16-18)

### Rear shock absorbers

The absorbers are of double-acting type. By trying to contract and extend each absorber by hand, the effectiveness of its damping action can be told. Absorbers found with oil leak or with inadequate damping effectiveness must be replaced.

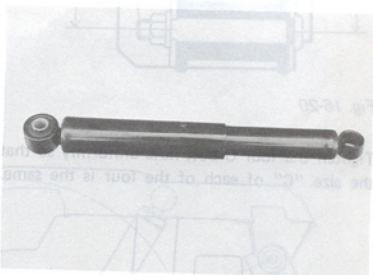


Fig. 16-19

### Shackle pin bushes and leaf spring bushes

Check leaf spring bolts or pins for play caused by wear of each bush. Also check each bush for crack or damage. If a defective bush is found, replace it.

## 16-10. Important Steps in Installation (Rear)

### Rear leaf spring

- When installing the leaf spring, make sure that 2 shackle pins are in parallel. At this time, parallelness A - B should be within  $\pm 0.3$  mm (0.0118 in).
- Mount shackle pins and front bolts in the direction toward the center of the car.

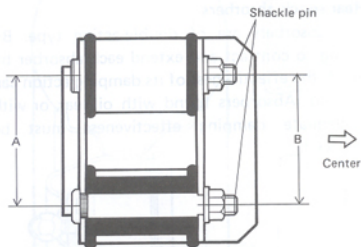


Fig. 16-20

Tighten the four U bolt nuts uniformly so that the size "C" of each of the four is the same.

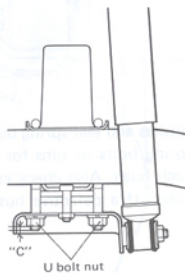


Fig. 16-21

### Wheel bearing

- Make the space "D" (between the inner bearing and the outer bearing) about 40% full with wheel bearing grease.
- Press-fit the inner bearing with its sealed side directed toward the backing plate side.

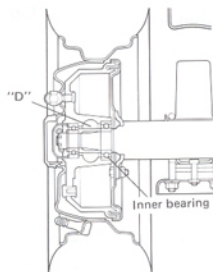


Fig. 16-22

### Hub bolts

When mounting the hub bolts into the drum, make sure to fit the head securely in the stepped part of the drum.

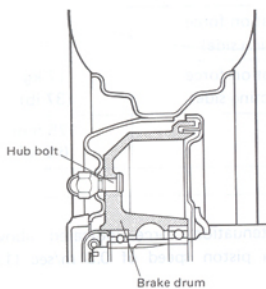


Fig. 16-23

## Tightening torque

	Fastening parts	N·m	kg·m (lb·ft)
①	Rear axle castle nuts	80 - 120	8.0 - 12.0 (58.0 - 86.5)
②	Rear shock absorber upper nuts	45 - 70	4.5 - 7.0 (33.0 - 50.5)
③	Rear shock absorber lower nuts	11 - 17	1.1 - 1.7 (8.0 - 12.0)
④	Rear brake backing plate nuts	18 - 28	1.8 - 2.8 (13.5 - 20.0)
⑤	U bolt nuts	30 - 45	3.0 - 4.5 (21.5 - 33.0)
⑥	Rear leaf spring front nuts	45 - 70	4.5 - 7.0 (33.0 - 50.5)
⑦	Rear leaf spring shackle pin nuts	30 - 55	3.0 - 5.5 (22.0 - 39.5)
⑧	Wheel nuts	50 - 70	5.0 - 7.0 (36.5 - 50.5)

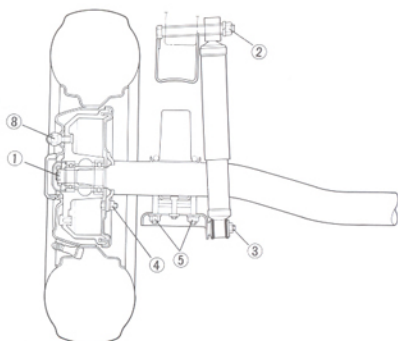


Fig. 16-24

## Rear shock absorber

After installing the absorber in correct position as shown in Fig. 16-25, tighten the lower nut first and then tighten the upper nut.

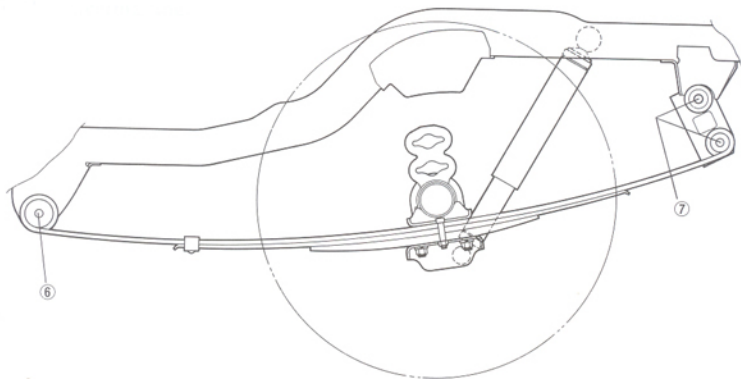
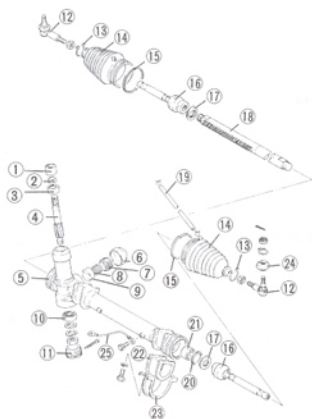


Fig. 16-25



## 17-1. Description

The steering system is of the rack-and-pinion type with a simple structure as illustrated below, which provides dynamic maneuverability. And two joints installed in the steering shaft offer a large leg space. Steering power is transmitted to the front wheel via the steering wheel, steering shaft, shaft joint, steering pinion shaft, steering rack, steering tie rod pipe, steering tie rod end, and steering knuckle.



- |                               |                              |                               |
|-------------------------------|------------------------------|-------------------------------|
| ① Steering pinion bush        | ② Needle bearing             | ③ Pinion bearing inner spacer |
| ④ Steering pinion             | ⑤ Steering gear case         | ⑥ Rubber cap                  |
| ⑦ Rack damper screw           | ⑧ Plunger spring             | ⑨ Steering rack plunger       |
| ⑩ Bearing                     | ⑪ Pinion bearing plug        | ⑫ Tie rod end                 |
| ⑬ Clip                        | ⑭ Rack boot                  | ⑮ Rack boot wire              |
| ⑯ Tie rod                     | ⑰ Lock washer                | ⑱ Steering rack               |
| ⑲ Tube                        | ⑳ C ring                     | ㉑ Rack bush                   |
| ㉒ Steering gear case mounting | ㉓ Steering gear case bracket | ㉔ Dust seal                   |
| ㉕ Horn earth lead wire        |                              |                               |

Fig. 17-1

## 17-2. Specifications and Data

Steering gear box	Rack and pinion type
Gear ratio	17.5 : 1
Steering angle, inside	38° (degrees)
Steering angle, outside	32° (degrees)
Steering wheel diameter	384 mm (15.1 in)
Minimum turning radius	4.4 m (14.4 ft.)

### 17-3. Removal

#### Steering handwheel

Depress the horn button, turn it counterclockwise and take out the button.



Fig. 17-2

Remove the steering shaft nut and pull off the steering wheel from the steering shaft.

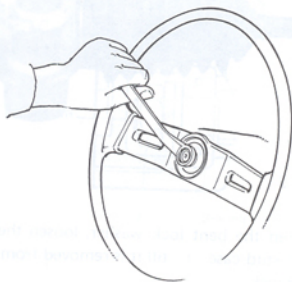


Fig. 17-3

When removing the steering gear case, follow the procedure described below.

#### Steering gear case

Remove the steering joint cover.

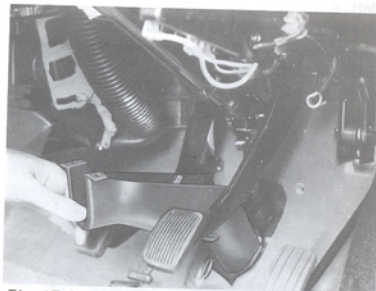


Fig. 17-4

Loosen the joint bolt securing the pinion shaft.

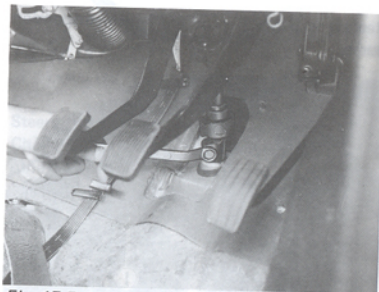


Fig. 17-5

Remove the nuts fastening the tie rod ends to the steering knuckle and remove the tie rod ends (left & right) from the steering knuckle using special tool A (09913 - 65210).

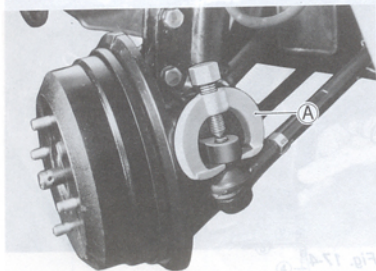


Fig. 17-6

Remove a part ① of the engine suspension frame.

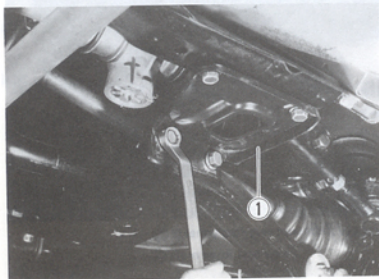


Fig. 17-7

Remove the steering gear case tightening bolts and take off the gear case with the tie rods and tie rod ends from the car body.

Gear ratio	17.1
Steering angle, inside	30
Steering angle, outside	32
Steering wheel diameter	38
Minimum turning radius	4.4

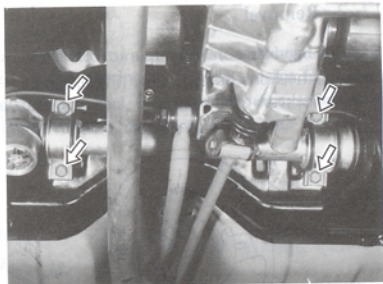


Fig. 17-8

Remove the wires and clamps binding the steering rack boots, and disconnect the steering rack breather hose.

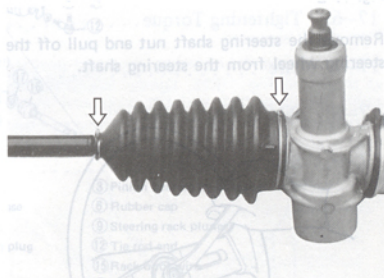


Fig. 17-9

Straighten the bent lock washer, loosen the tie rod ball stud case ① till it is removed from the steering rack.

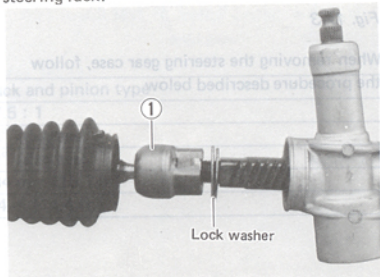


Fig. 17-10

Remove steering rack damper screw ② and remove spring ③ and plunger ④ .

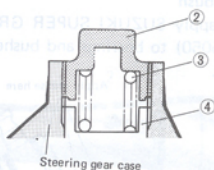


Fig. 17-11

Draw out cotter pin ⑤ from the steering pinion case, remove the pinion bush plug ⑥ and nut ⑦ fixing the pinion shaft.

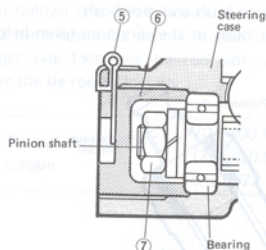


Fig. 17-12

Remove the pinion shaft, and then steering pinion bearing and pinion bush.

## 17-4. Maintenance Services

### Steering wheel play

The wheel play is proper if it is anywhere between 0 and 15 mm (0 and 0.6 in.) as measured at the rim. An unusually large play means that the ball-and-socket joints are loose or that wear in the steering gear box is excessively large.



Fig. 17-13

### Steering shaft joint

Check the shaft joint for wear, breakage and other damage and replace if any defect exists.

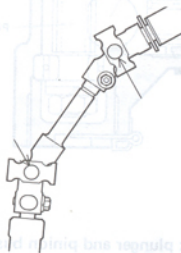


Fig. 17-14



### Steering rack boot

Check the steering rack boot for deterioration, cracks and other damage and replace if defective.

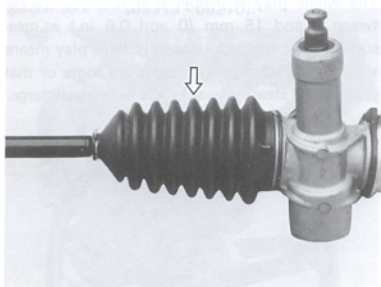


Fig. 17-15

### Steering rack & pinion

Check the rack & pinion tooth surface for wear, breakage and other damage and replace if any defect exists.

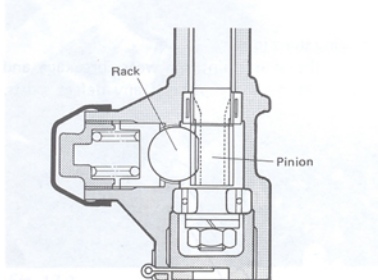


Fig. 17-16

### Steering rack plunger and pinion bush

Check the steering rack plunger and pinion bush for wear, breakage and other damage and replace if defective.

## 17-5. Important Steps in Reassembly

Reassemble parts in the reverse order to disassembly, paying attention to the following points.

### Bearing and bush

Be sure to apply SUZUKI SUPER GREASE E (99000 - 25050) to bearings and bushes before fitting them.

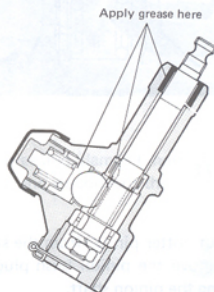


Fig. 17-17

### Steering pinion bush and rack bush

Press in the bush in the direction given below.

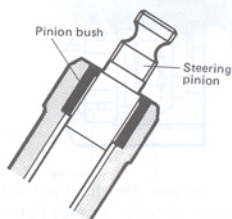


Fig. 17-18

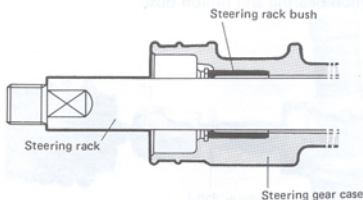


Fig. 17-19



### Steering gear case

Remove the bolt ② and, through its hole, inject SUZUKI Super Grease E (99000-25050) into the steering gear case enough to fill up inside of it.

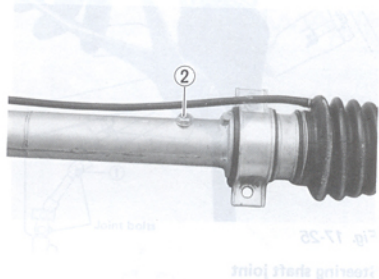


Fig. 17-20

### Steering tie rod

Install the steering tie rod on the steering rack and tighten it to the torque specified below. At this time, place the washer in such a way that its larger side faces the tie rod side and bend it over the tie rod to lock it.

Tie rod tightening torque	70 - 100 N·m (7.0 - 10.0 kg·m) 51.0 - 72.0 lb-ft
---------------------------	--

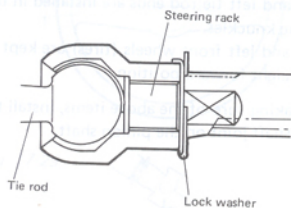


Fig. 17-21

### Pinion bearing bush plug

The pinion bearing bush plug prevents the bearing from coming out. After tightening it to the specified tightening torque, be sure to fit a cotter pin ③.

Tightening torque specifications	
Pinion bearing bush plug ④	45 - 80 N·m (4.5 - 8.0 kg·m) 32.5 - 57.5 lb-ft
Steering pinion securing nut ⑤	55 - 80 N·m (5.5 - 8.0 kg·m) 40.0 - 57.5 lb-ft

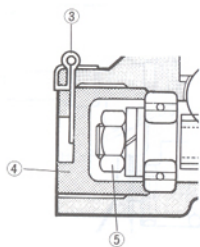


Fig. 17-22

### Steering rack damper screw

The steering rack damper screw should be adjusted after being tightened. Tighten the damper screw so that the average working torque of the pinion shaft is 0.8 - 1.3 N.m (8 - 13 kg-cm, 0.58 - 0.94 lb-ft) when the steering pinion shaft is turned through 0 - 180° with the steering rack positioned at the same distance to the right and left of the gear case.

#### NOTE:

Height  $H$  as illustrated below after the damper screw is tightened should be less than 0 - 1 mm (0 - 0.04 in.) from the gear case face.

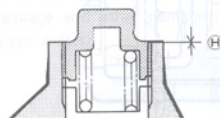


Fig. 17-23

### Steering rack boots

Fit the boots on the steering rack in such a way that the plug of the boots is in the position as shown below.

Fig. 17-16

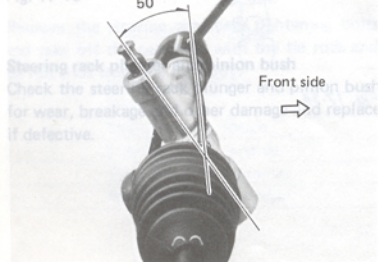


Fig. 17-24

After fitting the clamps, tighten both ends of the clamps with pliers.

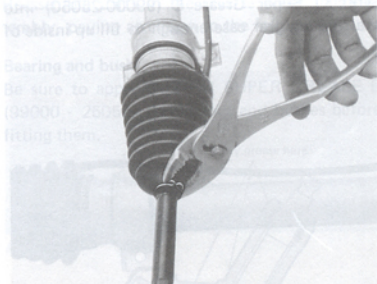


Fig. 17-25

### Steering shaft joint

Connecting the steering shaft with the pinion shaft presupposes the following conditions.

- Right and left tie rods are installed in such a way that length "A" of both rod ends is equal.

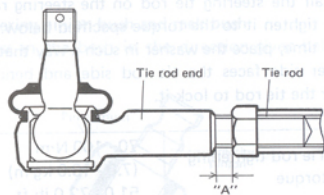


Fig. 17-26

- Right and left tie rod ends are installed in the steering knuckles.
- Right and left front wheels (tires) are kept in the straight forward position.

After making sure of the above items, install the steering shaft joint on the pinion shaft.

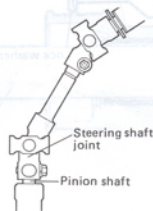


Fig. 17-27

Tighten the joint bolt on the pinion shaft side, column bolts and then joint bolt ① .

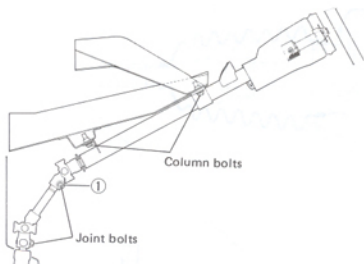


Fig. 17-28

#### Steering wheel

Align the front wheels for straight ahead and fit the steering wheel on the steering shaft so that the steering wheel spoke is horizontal or makes an angle of not more than  $6^\circ$  to the horizontal.

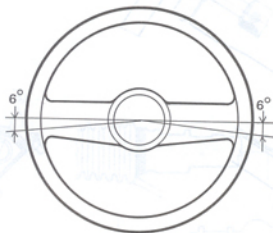


Fig. 17-29

#### WARNING:

After installing all parts, be sure to inspect and readjust wheel alignment. At the same time, confirm that the steering angle is correct.

#### Steering rack boots tube

When installing the tube, check to be sure that no grease is in it. Also be careful not to dent the tube when clamping it.

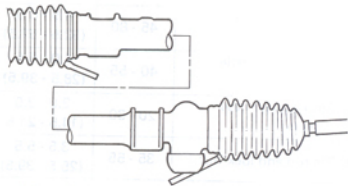


Fig. 17-30

#### Steering shaft bushes and washer

Apply SUZUKI SUPER GREASE A (99000-25010) to the inner groove of the bush ① and the upper and lower surfaces of the steering shaft washers ② before fitting them.

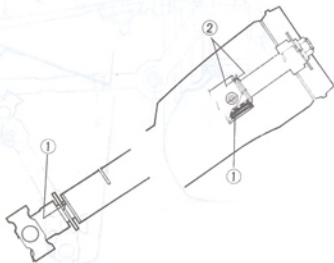


Fig. 17-31

## 17-6. Tightening Torque

	Fastening parts	N·m	kg-m (lb-ft)
①	Steering shaft nut	25 - 40	2.5 - 4.0 (18.0 - 28.5)
②	Steering shaft joint bolt	20 - 30	2.0 - 3.0 (14.5 - 21.5)
③	Steering column bolt	11 - 17	1.1 - 1.7 (8.0 - 12.0)
④	Tie rod ball stud case nut	70 - 100	7.0 - 10.0 (51.0 - 72.0)
⑤	Steering pinion securing nut	55 - 80	5.5 - 8.0 (40.0 - 57.5)
⑥	Pinion bearing bush plug	45 - 80	4.5 - 8.0 (32.5 - 57.5)
⑦	Tie rod end castle nut	40 - 55	4.0 - 5.5 (28.5 - 39.5)
⑧	Steering gear case bolt	20 - 30	2.0 - 3.0 (14.5 - 21.5)
⑨	Tie rod end lock nut	35 - 55	3.5 - 5.5 (25.5 - 39.5)
⑩	Wheel nuts	50 - 70	5.0 - 7.0 (36.5 - 50.5)

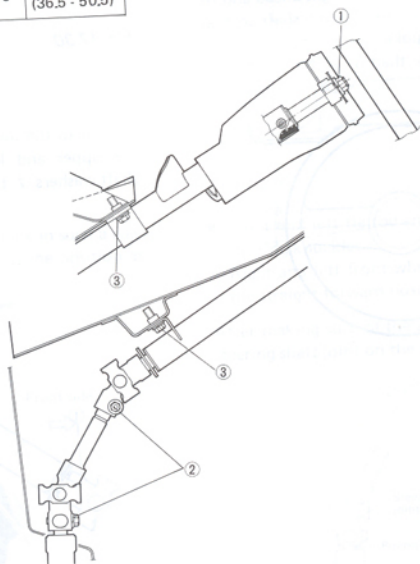


Fig. 17-32

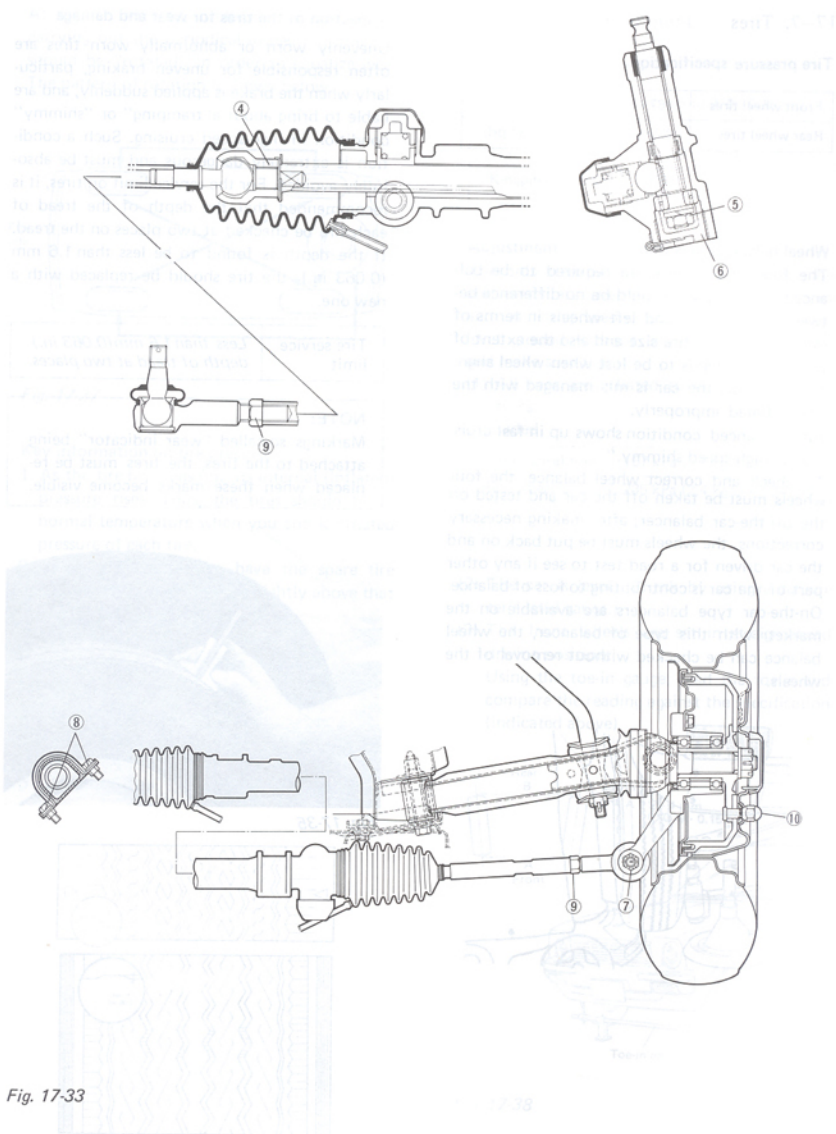


Fig. 17-33



## 17-7. Tires

### Tire pressure specification

Front wheel tires	167 kPa (1.7 kg/cm <sup>2</sup> , 24 psi)
Rear wheel tires	235 kPa (2.4 kg/cm <sup>2</sup> , 34 psi)

### Wheel balance inspection

The four road wheels are required to be balanced, that is, there should be no difference between right wheels and left wheels in terms of inflated pressure, tire size and also the extent of wear. Balance tends to be lost when wheel alignment is poor, the car is mis managed with the tires inflated improperly.

An unbalanced condition shows up in fast cruising as "high-speed shimmy."

To check and correct wheel balance, the four wheels must be taken off the car and tested on the off-the-car balancer; after making necessary corrections, the wheels must be put back on and the car driven for a road test to see if any other part of the car is contributing to loss of balance. On-the-car type balancers are available on the market: with this type of balancer, the wheel balance can be checked without removal of the wheels.

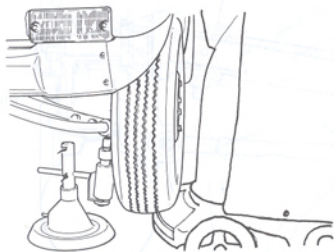


Fig. 17-34

### Inspection of the tires for wear and damage

Unevenly worn or abnormally worn tires are often responsible for uneven braking, particularly when the brake is applied suddenly, and are liable to bring about a "tramping" or "shimmy" condition in high-speed cruising. Such a condition is extremely dangerous and must be absolutely avoided. For the service limit on tires, it is recommended that the depth of the tread of each tire be checked at two places on the tread. If the depth is found to be less than 1.6 mm (0.063 in.), the tire should be replaced with a new one.

Tire service limit	<i>Less than 1.6 mm (0.063 in.) depth of tread at two places.</i>
--------------------	---

### NOTE:

Markings so-called "wear indicator" being attached to the tires, the tires must be replaced when these marks become visible.



Fig. 17-35

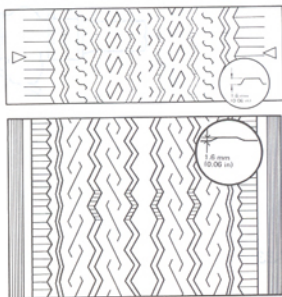


Fig. 17-36

At regular intervals, preferably at the time of carrying out the periodical inspection, the tires should be "rotated" in order to equalize wear. The pattern of rotation is shown below.

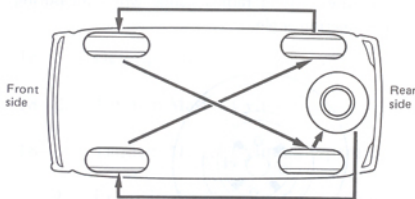


Fig. 17-37

**Key information on tire pressure**

1. As the tire becomes hot, its internal (inflated) pressure rises. Thus, the tires should be at normal temperature when you check inflated pressure of each tire.
2. It is good practice to have the spare tire inflated to a pressure value slightly above that specified.

**17-8. Wheel Alignment**

**Alignment service data**

Toe-in	2 - 4 mm (0.079 - 0.157 in.)
Camber	1° 20'
Trail	13 mm (0.51 in.)
Kingpin inclination	12° 50'
Caster	3° 15'

**Adjustment**

The only item of adjustment is toe-in. Camber and caster are given and fixed. Before checking and adjusting toe-in, let the car stand on flat level ground without any load placed aboard, and make sure that—

- (1) All tires are inflated to the following pressures:

Unloaded

Front wheel tires	167 kPa (1.7 kg/cm <sup>2</sup> , 24 psi)
Rear wheel tires	235 kPa (2.4 kg/cm <sup>2</sup> , 34 psi)

- (2) The car is level. (Check by using a carpenter's level gauge.)
- (3) The front wheels are set in straightahead driving position.

Using the toe-in gauge, read the toe-in and compare the reading against the specification (indicated above).

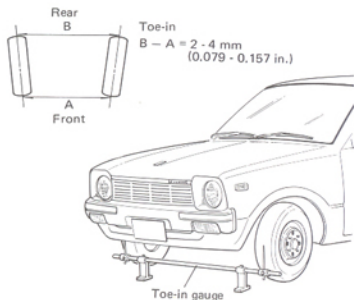


Fig. 17-38



## 18-1. Description

By depressing the foot brake pedal, oil pressure is generated in the master cylinder and causes piston at each wheel to operate.

A Tandem Master Cylinder is employed for this model. In a master cylinder of this type, oil pressure is transmitted independently to the front wheel and rear wheel brakes. Even if the pressure fails in either the front or rear brake oil line, the other braking system works, thus ensuring high safety driving.

The brake system has two leading shoes in the front wheel brakes, and one leading shoe and one trailing shoe in the rear wheel brakes.

The parking brake is mechanically operated by a wire and link system. It works on the rear wheels only. The same brake shoes are used for the parking and foot brakes.

- ① Master cylinder
- ② Proportioning & bypass valve
- ③ Brake pipe 3 way joint
- ④ Brake pipe 2 way joint

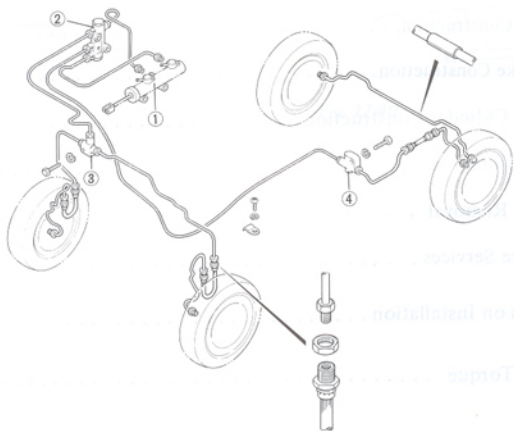


Fig. 18-1

## 18-2. Tandem Master Cylinder

The tandem master cylinder is similar in construction to an ordinary master cylinder, the principal differences being that it has two pistons and four piston cups and that hydraulic pressure is developed in two chambers, one for front brakes and the other for rear brakes.

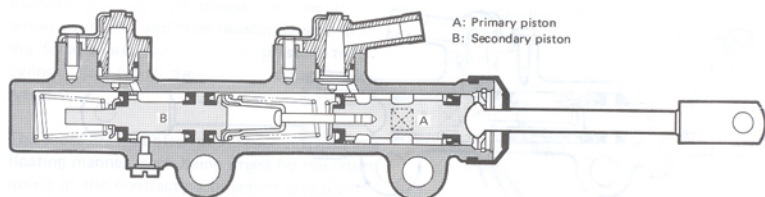


Fig. 18-2

## 18-3. Tandem Master Cylinder Operation

### Normal operation

Depressing the brake pedal forces primary piston "A" toward the left (in Fig. 18-3) to pressurize the oil immediately ahead for front brakes. By this pressure and by the force of return spring, secondary piston "B" moves similarly to pressurize the oil for rear brakes.

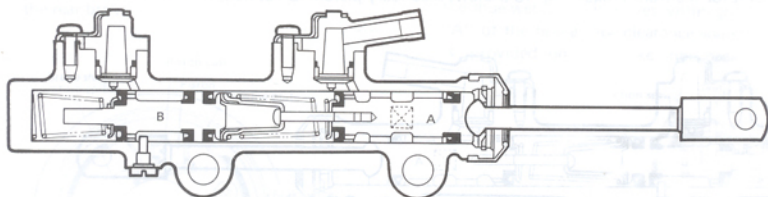


Fig. 18-3



#### One-circuit operation (front-brake circuit failure)

Depressing the brake pedal causes primary piston "A" to move as above but, because the front-brake circuit cannot hold pressure, the oil immediately ahead of this piston does not get pressurized. As piston "A" keeps moving, compressing the spring, it begins to push piston "B" when the spring has been compressed fully. From this point on, piston "B" moves to pressurize the oil ahead and thus actuate the rear brakes.

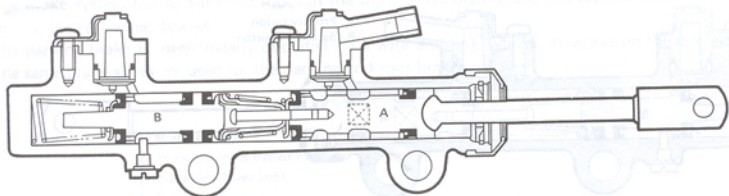


Fig. 18-4

#### One-circuit operation (rear-brake circuit failure)

In this case, the leftward movement of piston "A" has but little effect in pressurizing its oil (for front brakes) at first, because the initial rise in oil pressure causes piston "B" to promptly yield and move toward the left. Very soon the forward end of piston "B" comes to and bears against the head of the cylinder. From this point on, the leftward movement of piston "A" becomes effective to pressurize the oil ahead of it for the front brakes. Fig. 18-5 shows secondary piston "B" at halt.

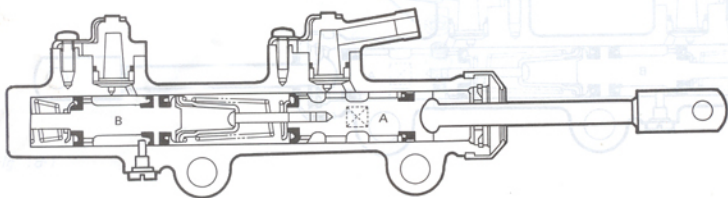


Fig. 18-5

## 18-4. Front Brake Construction and Operation

There are two wheel cylinders. Each cylinder has one piston, by which it pushes the leading end of its shoe. In other words, the two shoes begin to rub the drum in a "biting" manner the moment the hydraulic pressure applies to the wheel cylinders, and thus develop greater braking force more quickly as the pressure to the cylinder rises (when the machine is running forward).

The shoes are mounted on the backing plate in a floating manner, each being urged by the return spring in the contracting direction and pivoted as its trailing end.

And no adjustment is required for the front brake shoe clearance as the self shoe clearance adjusting system of the front brake in this model is, by its structure, able to provide a proper front brake shoe clearance all the time. Therefore, the front wheel cylinder doesn't include the brake shoe clearance (shoe-to-drum clearance) adjuster consisting of a notched wheel and bolt, though the cars of other models have one.

### NOTE:

Shoe clearance adjustment is necessary for the rear brake.

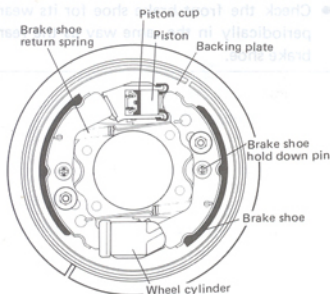


Fig. 18-6

### [Clearance correction]

In each front wheel cylinder, a piston, a piston cup, a spring seat and a piston spring ① are installed. When the brake pedal is depressed, oil pressure is applied to the inside of the chamber on the right side of piston ②. Being actuated by this pressure, the piston moves to the left in the following figure and presses the brake shoe against the brake drum, thus producing brake power.

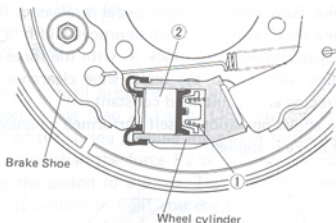


Fig. 18-7

The movement of the brake shoe at this time equals to the movement of the brake shoe clearance adjusting bolt ③ which is mounted on the shoe web when it moves within groove width "A" of the brake shoe clearance adjusting block ④ provided on the brake shoe backing plate.

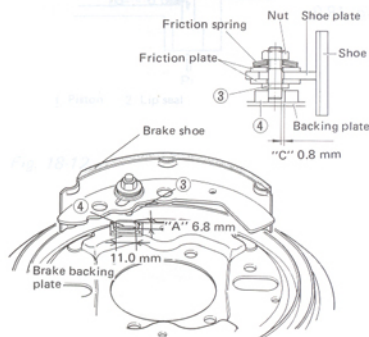


Fig. 18-8

When the brake shoe is worn and the brake shoe clearance gets larger (longer brake pedal travel), the piston and the brake shoe actuated by the depressed pedal move toward the brake drum side as much as the width "C" of the adjusting block ④, causing adjusting bolt ③ to strike against "B" part of block ④. And when this striking force amounts to about 30-60 kg (66.0-132.0 lbs), bolt ③ slides within oblong hole ⑤ in the shoe web in accordance with the amount of the brake lining wear and thus the shoe pressing against the drum results in applying the brake. Now when the brake pedal is released, the brake shoe returns as much as groove width "C" (proper clearance) of block ④ with the force of return springs and the brake shoe clearance is corrected and maintained constant. The above operation is self performed whenever the brake is applied.

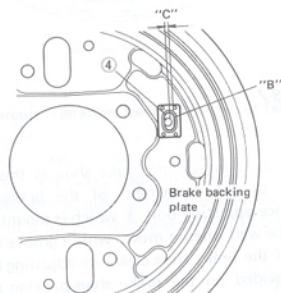


Fig. 18-9

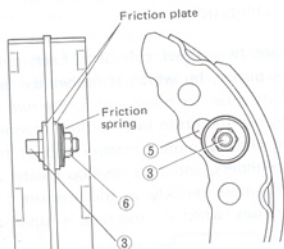


Fig. 18-10

The piston, too, returns to the specified shoe clearance when the brake pedal is released, as it is controlled by the piston spring in the wheel cylinder.

#### CAUTION:

- It is prohibited positively to tighten or loosen bolt ③ and nut ⑥, since the friction power is utilized in the brake system.
- When the front brake shoe is replaced, make sure to depress the brake pedal a few times at 30 - 40 kg ( 66 - 88 lbs) after installation so as to obtain a proper brake shoe clearance.
- Check the front brake shoe for its wear periodically in the same way as the rear brake shoe.

## 18-5. Proportioning & Bypass Valve Construction and Operation

### Proportioning valve

The proportioning valve serves to control the oil pressure applied to the rear wheel cylinder of this model.

When the brakes are applied, the center of gravity of a car moves forward with a decrease of car speed and a change in load on the front and rear wheels.

When a high running speed is rapidly decreased, rear wheels are locked earlier than front wheels causing unstable maneuverability.

To prevent this, a proportioning valve is installed to reduce the oil pressure supplied to the rear wheels when the car speed is rapidly reduced, thus providing highly effective and well-balanced braking of all wheels at any time.

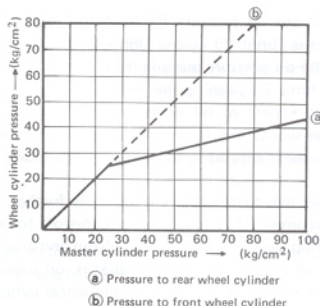


Fig. 18-11

When the oil pressure  $P_1$  from the master cylinder is less than 25 kg/cm<sup>2</sup> (355 psi), the force  $F_1$  of the spring pushing the piston to the right is larger than the force  $F_2$  of oil pressure pushing the piston to the left. Therefore, the piston ① is pushed to right and the brake oil is led to the rear wheel cylinder, passing between the piston and lip seal ②. Thus, all the oil pressure from the master cylinder is transmitted to the rear wheel cylinders.

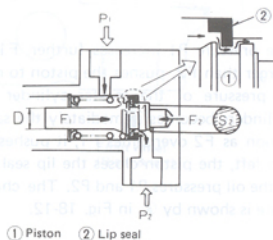


Fig. 18-12



When the oil pressure  $P_1$  from the master cylinder is about  $25 \text{ kg/cm}^2$  (355 psi), the force  $F_2$  of the oil pressure pushing the piston to left and the force  $F_1$  pushing the piston to right (spring force + part of oil pressure) are balanced. In other words, the total oil pressure of the master cylinder is applied to the rear wheel cylinder.

When the oil pressure  $P_1$  increases further,  $F_2$  overcomes  $F_1$  and pushes the piston to left. The lip seal ③ contacts the piston and cuts off the oil pressure  $P_1$  and  $P_2$ ; that is, oil pressure from the master cylinder to the wheel cylinder is cut off.

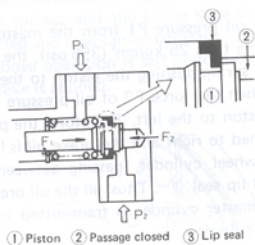


Fig. 18-13

When the pressure  $P_1$  increases further,  $F_1$  becomes larger than  $F_2$ , pushes the piston to right and the pressure of the master cylinder and wheel cylinders becomes immediately the same. But as soon as  $F_2$  overcomes  $F_1$ , it pushes the piston to left, the piston closes the lip seal and cuts off the oil pressures  $P_1$  and  $P_2$ . The change of pressure is shown by ④ in Fig. 18-12.

#### [Reference]

The force required to move the piston to left is given from the area:

$$S_2 = 0.549 \text{ cm}^2$$

The force required to move the piston to right is given from the area:

$$S_0 = S_2 - S_1 = S_2 - \frac{\pi}{4} D^2$$

$$= 0.549 - 0.410 = 0.139 \text{ cm}^2$$

$$\text{Spring force } P_3 = 9.3 \text{ Kg}$$

Force to move the piston to right:

$$F_1 = P_1 (S_2 - S_1) + P_3$$

Force to move the piston to left:

$$F_2 = P_2 \times S_2$$

When the oil pressure  $P_1$  on the master cylinder side and  $P_2$  on the wheel cylinder side are the same,  $30 \text{ Kg/cm}^2$  (426 psi):

$$F_1 = 30 \times 0.139 + 9.3 = 13.47 \text{ Kg}$$

$$F_2 = 30 \times 0.549 = 16.47 \text{ Kg}$$

therefore, when  $F_2$  is higher than  $F_1$ , the piston is pushed to left and cuts off pressure to the cylinder. When the oil pressure  $P_1$  of the master cylinder is increased from 30 to  $55 \text{ Kg/cm}^2$  (782 psi):

$$F_1 = 55 \times 0.139 + 9.3 = 16.95 \text{ Kg}$$

$$F_2 = 16.47 \text{ Kg (no change)}$$

therefore,  $F_1$  is higher than  $F_2$ , the piston is pushed to right, opens a passage to the wheel cylinder instantly but immediately cuts off  $P_1$  and  $P_2$ .

#### Inspection and service

Any defect in the proportioning valve will lock the rear wheels faster than the front wheels and cause unstable maneuverability of the car. It is therefore recommended to replace the valve periodically.

Replacement interval for proportioning valve	4 (four) years
--	----------------



## Bypass valve

When the front brake system is damaged and braking power is significantly reduced, the bypass valve overrides the proportioning valve of the rear brake system so that all the oil pressure produced in the master cylinder is passed to the rear wheel cylinder to compensate for the lost braking power.

### [Construction]

In Fig. 18-14, "A" indicates the proportioning valve and "B", the bypass valve. Seal ② is installed at the end of piston ① and serves to close the oil passage between ⑤ and ⑥. "O" rings, ③ and ④, seal off the pressure systems of the rear wheel cylinder and front wheel cylinders. On the side (right) opposite the seal, spring ⑦ is installed.

The spring pushes the seal ② against the end of the cylinder so that the seal ② completely prevents any oil flow between ⑤ and ⑥. Spring ⑦ also acts as the return spring for piston ①.

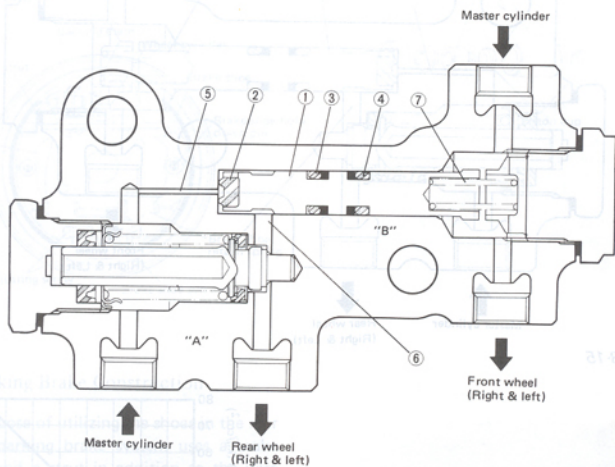


Fig. 18-14

[Operation]

While the front and rear brake systems are operating normally, on depressing the brake pedal, the piston ① is not moved since the oil pressure is applied to both surfaces of the piston, but is maintained in the neutral position so sealing off the oil passage between ⑤ and ⑥ by means of the force of spring ⑦. At this time, normal performance of the proportioning valve as shown by ③ in Fig. 18-16 is ensured.

When there is an oil leak in the front brake system, oil pressure to the front brake system is cut off almost completely. The piston ① is pushed to right by the oil pressure of the rear brake (spring ⑦ is compressed by the oil pressure) and the oil passage between ⑤ and ⑥ is opened. The proportioning valve stops operation as shown by ④ in Fig. 18-16, and all the pressure generated in the master cylinder of the rear brake system is supplied to the rear wheel cylinders as shown by ⑤ in Fig. 18-16.

Therefore, oil pressure higher than normal when the front brakes are effective, is applied to the rear wheel cylinders.

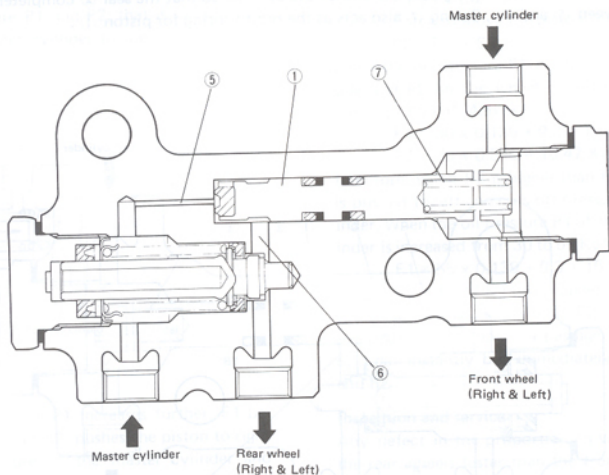


Fig. 18-15

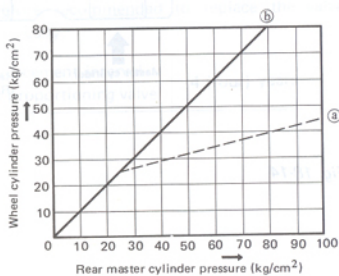


Fig. 18-16

## 18-6. Rear Brake Construction

The rear brake has a double-piston type wheel cylinder interposed between the leading end of one shoe and the trailing end of the other. The other ends of these shoes pivot on the adjuster sleeve complete with an adjusting screw.

When hydraulic pressure applies to the wheel cylinder, which is bolted to the backing plate, the two pushrods of this cylinder move out to spread the shoes apart against the force of two return springs.

Brake adjustment is to be effected by turning the notched screw of the adjuster sleeve. This screw is accessible through a hole provided in the brake drum.

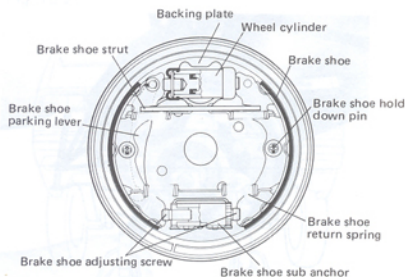


Fig. 18-17

## 18-7. Parking Brake Construction

For the purpose of utilizing the shoes in the rear brake, the parking brake system uses a brake shoe lever and a strut in addition to the wire cable for transmitting the manual effort (exerted to the parking lever) to the rear brakes. The shoe lever and strut are mounted on the backing plate of each brake in a floating manner.

The strut is to parking brake what the wheel cylinder is to foot brake. Pulling the parking lever causes the strut to expand the two shoes and push them against the drum

## 18-8. Rear Wheel Cylinder Construction

The double-piston cylinder used in the rear brake has two pistons, each backed by a cup and fronted by a boot. A pushrod or actuating pin bears, against the piston by its inner end and is fitted to the shoe web by its outer end.

A bleeder screw is provided in the cylinder proper. This screw is a plug; it is to be removed only when air trapped in the circuit has to be vented out.

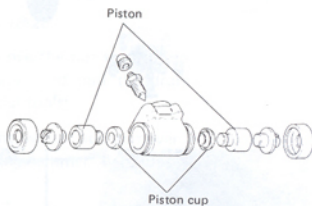


Fig. 18-18

## 18-9. Front Brake Removal

Lift the front end (suspension frame) of the machine by jacking, and support it with safety stands.



Fig. 18-19

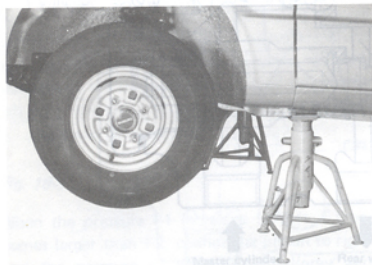


Fig. 18-20

Remove the hub nuts and take off a wheel.

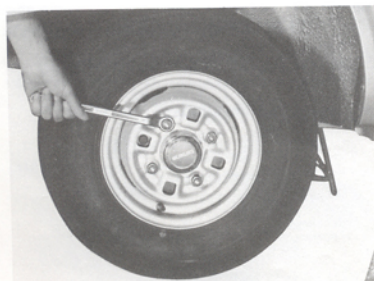


Fig. 18-21

Remove the brake drum by using two 6 mm bolts ①.

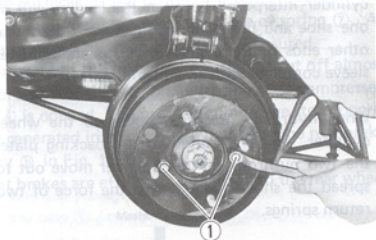


Fig. 18-22

Remove the brake shoe hold down pins.

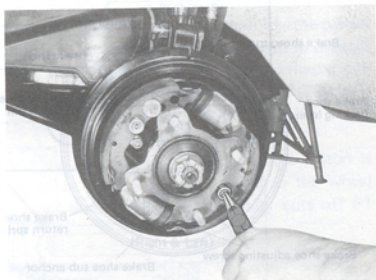


Fig. 18-23

Remove the brake shoes.

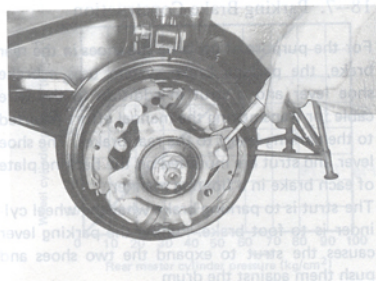


Fig. 18-24



## 18-10. Rear Brake Removal

Lift the rear axle of the machine by jacking, and support it with safety stands.

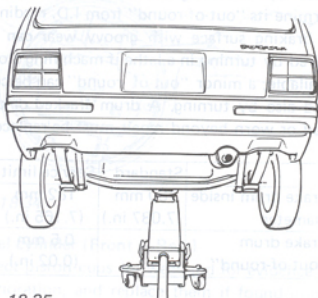


Fig. 18-25

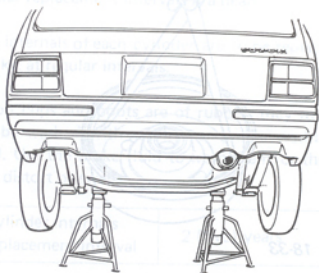


Fig. 18-26

Remove the hub nuts and take off a wheel.

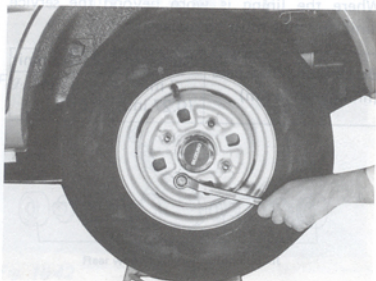


Fig. 18-27

Remove the spindle cap.

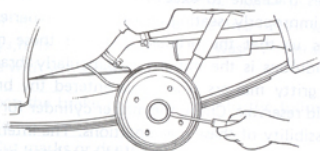


Fig. 18-28

Remove the nut securing the brake drum to the spindle, and pull the drum off by using these special tools:

Front wheel hub remover **A** (09943-17910)  
Sliding hammer **B** (09942-15510)

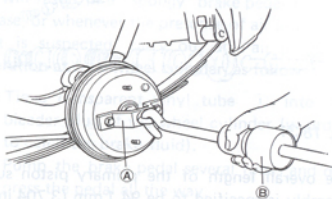


Fig. 18-29

Remove the brake shoe hold down pins.

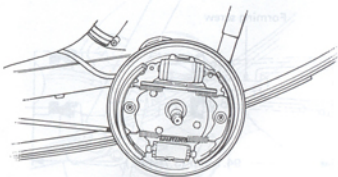


Fig. 18-30



## 18-11. Maintenance Services

### Master cylinder

Complaints on the master cylinder are in most cases traceable to excessively worn piston cups or improperly seating check valves; experience tells us that the primary cause of these malconditions is the impurities, particularly abrasive or gritty matters, that have entered the brake fluid reservoir. Check the master cylinder for the possibility of these malconditions. The internals of the master cylinder should be replaced at regular intervals, and they should be handled as a kit. The recommended interval is two years.

Master cylinder internals replacement interval	2 (two) years
--	---------------

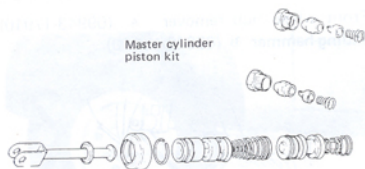


Fig. 18-31

The overall length of the primary piston sub-assembly is specified to be 94.1 mm (3.704 in.). This specification assumes great importance in the function of the master cylinder. When rebuilding this sub-assembly after its disassembly for overhaul or for replacement of piston cups, be sure to set the overall length to the specification value by means of the forming screw.

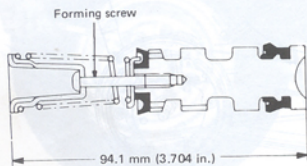


Fig. 18-32

### Brake drum (Front & Rear)

Inspect the drum for cleanliness. Remove oil stains, if any. Check the wear of its braking surface by measuring its inside diameter, and determine its "out-of-round" from I.D. readings. The braking surface with groovy wear can be repaired by turning in a lathe if machining stock is available; a minor "out-of-round" can be corrected also by turning. A drum cracked or distorted or worn beyond repair must be replaced.

	Standard	Service limit
Brake drum inside diameter	180 mm (7.087 in.)	182 mm (7.165 in.)
Brake drum "out-of-round"	0	0.5 mm (0.02 in.)

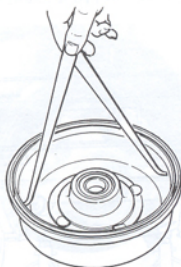


Fig. 18-33

### Brake shoe (Front & Rear)

Glazed surfaces, if any, of brake shoes can and must be reconditioned by grinding with sandpaper. Oil stains too can be removed similarly. Where the lining is worn beyond the service limit, the shoe must be replaced.

	Standard	Service limit
Brake lining thickness (lining + shoe rim)	7 mm (0.27 in.)	3 mm (0.12 in.)

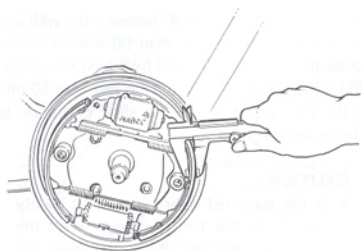


Fig. 18-34

#### Wheel cylinder (Front & Rear)

Inspect piston cups for wear and for evidence of deterioration, and replace them if found in defective condition, even when the end of the regular replacement intervals is a head.

The internals of each cylinder are to be replaced as a kit at regular intervals.

Piston cups and boots are of rubber; they must not be washed with gasoline or similar washing fluid. Use the brake fluid to wash them, or they may distort or swell.

Cylinder internals replacement interval	2 (two) years
---	---------------



Front wheel cylinder piston cup kit

Fig. 18-35



Rear wheel cylinder piston cup kit

Fig. 18-36

#### Brake pipes

The brake pipes are double-layer wound type, made by rolling steel strip into a two-layer wall pipe, with its surfaces treated for rust prevention. After driving the machine along in sea water at the beach or in a shore area full of salt sprays, it is a good practice to wash the brake pipes with soft water.

Inspect the brake pipes in regard to the following items

- (1) Cut marks or dents
- (2) Leakage of brake fluid
- (3) Signs of rubbing at the clamps and clips
- (4) Rusting or corrosion

#### Air purging

Whenever any component or part of the foot brake system has been replaced, reconnected or otherwise worked on to expose the brakefluid side of the circuit to the atmosphere, some air will get into the circuit; and the presence of such air will result in a "spongy" brake pedal. In such a case, or whenever the presence of air in the circuit is suspected, carry out an "air purging" operation at each wheel cylinder, as follows:

- (1) Tie a transparent vinyl tube ① into the bleeder plug of the wheel cylinder (in order to catch the brake fluid).
- (2) Pump the brake pedal several times and depress the pedal all the way.
- (3) Loosen the bleeder plug by turning it a half rotation. The fluid with air bubbles will come out. Tighten up the plug when air bubbles stop coming out.

This operation requires two persons, one at the brake pedal and one at the wheel cylinder.

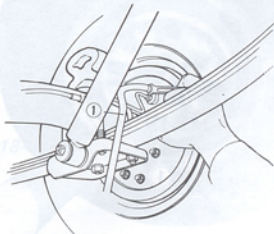


Fig. 18-37

### Brake fluid

The brake system uses a glycol type brake fluid. When purchasing the replacement fluid, be sure to specify the glycol type meeting the following specifications:

Brake Fluid	Specifications
	DOT 3, DOT 4, SAE J1703

Some commercially available brake fluids are of silicone or petroleum base; do not use any of these fluid. Remember, any brake fluid which is a mixture of two or more brands is likely to effect some of the brake system components adversely, resulting in faulty braking.

The brake fluid in service is subject to gradual deterioration because the moisture content of air finds its way slowly into the brake fluid. For this reason the brake fluid should be regarded as an expendable item and be replaced at regular intervals.

Brake fluid change interval	2 (two) years
-----------------------------	---------------

### Rear brake shoe clearance adjustment

The hole for gaining access to the adjusting wheel or screw is provided in the brake drum. Through this hole, insert a screwdriver to turn the adjusting wheel or screw.

Turn the wheel or screw to expand the shoe all the way, locking hard the brake drum, and then turn it back 3 to 6 notches to introduce a drum-to-shoe clearance. Leave the adjusting wheel or screw right there.

Brake shoe clearance adjustment	Back away 3 to 6 notches
---------------------------------	--------------------------

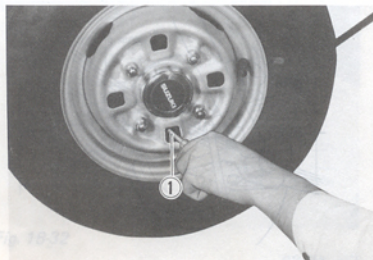


Fig. 18-38 ① Adjusting hole

### Brake pedal

Confirm that clearance ② between the wall and the pedal arm is more than 50 mm (1.97 in) when the pedal is depressed by a load of approx. 30 kg (66 lb). If the clearance is less than 50 mm (1.97 in), adjust the brake shoe clearance to obtain the specified value.

#### CAUTION:

- If the specified clearance cannot be obtained, or the feel is spongy when the pedal is depressed, check the shoes for excessive wear and the brake system for air entered.
- After reassembling the brake oil line, bleed air from the line.

#### NOTE:

Inspect pedal clearance daily, as well as at periodically scheduled inspection.

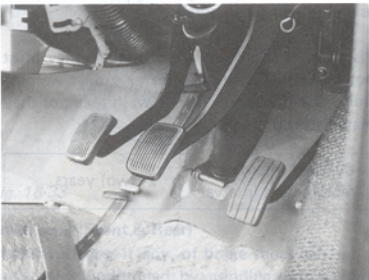


Fig. 18-39

Pedal-to-wall clearance ② (when pedal is depressed at 30 kg (66 lb))	50 mm (1.97 in.) minimum
--	--------------------------



Fig. 18-40



### Parking brake cable

Inspect the brake cable for damage, and check for smoothness of its movement. Oil the cable as necessary. A defective cable must be replaced. Advise the user to inspect and service the cable in this manner at regular intervals.

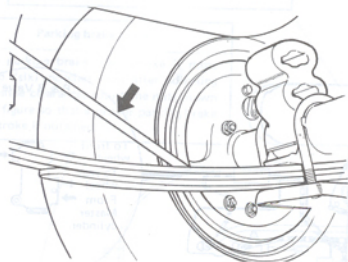


Fig. 18-41

### Brake hoses and pipes

These are critical safety parts and demand greater attention. Be always sure that the hoses and pipes are in good condition, free of any evidence of crack or breakage. A damaged hose or pipe or a rusted or leaking one must be replaced.

#### CAUTION:

After replacing any of the brake pipes or hoses, be sure to carry out an air bleeding operation. You are duty-bound to do this before releasing the serviced machine to the user.

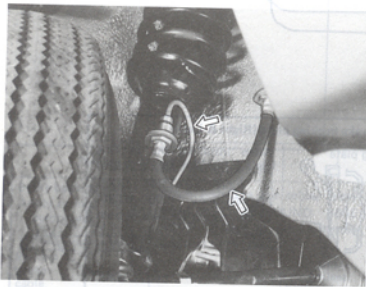


Fig. 18-42

### Parking brake lever

Pull up the parking brake lever all the way with one hand to apply brake fully, and see how many notches of the ratchet of the lever has traversed. If the lever moves by more than 6 notches, it means that the shoe-to-drum clearance in the rear brakes is too much and needs to be readjusted to the specification. Through the hole provided in the brake drum, insert a screwdriver and back away the adjusting screw 3 to 6 notches from its zero-clearance position, as in the case of the wheel brake.

Parking brake stroke (1)	6 notches maximum
Brake shoe clearance adjustment	Back away 3 to 6 notches



Fig. 18-43

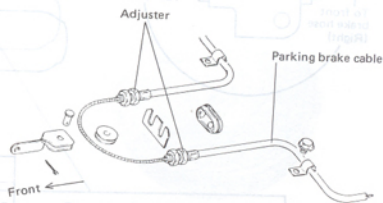
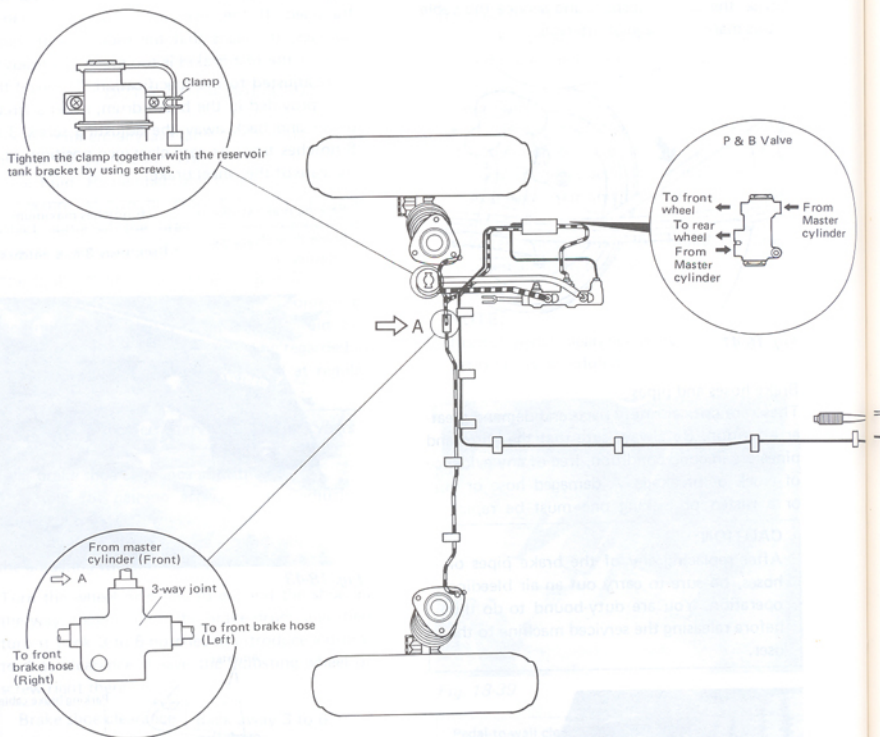


Fig. 18-44

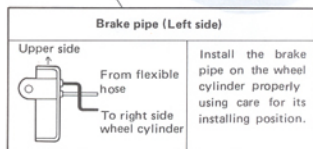
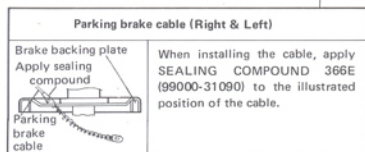
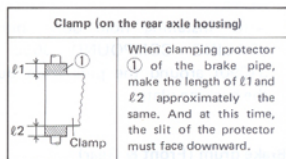
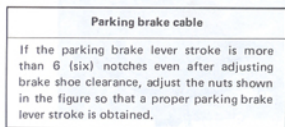
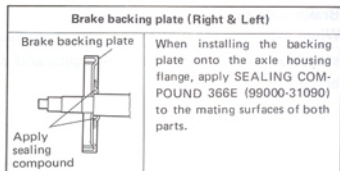
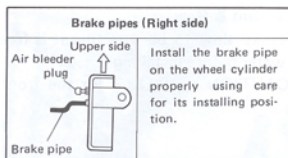
## 18-12. Precautions on Installation



Brake backing plate (Right & Left)	
<p>Backing plate Brake drum Apply sealing compound</p>	<p>When installing the backing plate onto the steering knuckle, apply SEALING COMPOUND 366E (99000-31090) to the mating surfaces of both parts.</p>

Fig. 18-45





### Brake shoe hold down pin (Front & Rear)

When installing the brake shoe, ensure correct installation of the shoe hold down pins and washers (3).

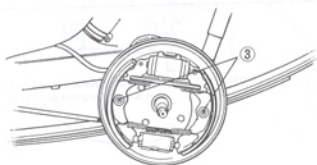


Fig. 18-46

#### NOTE:

After installing hold down pins, apply SEALING COMPOUND 366E (99000-31090) around the pins from outside of the backing plate.

### Brake drum (Front & Rear)

Check inside of the brake drum to be sure that it is free from rust, oil or any foreign matter before installing it.

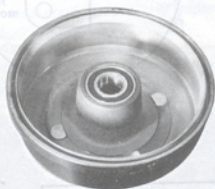


Fig. 18-47

### Brake shoe (Front & Rear)

Check the brake shoe to be sure that it is free from oil or water before installing it. (Refer to CAUTION on P. 18-6 for the front brake shoe)

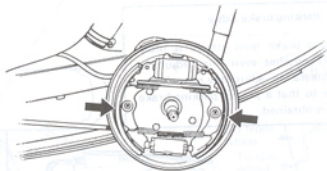


Fig. 18-48

### Brake flexible hose

In case of the front hose, fit its body side first and in case of the rear hose, its housing side first.

When tightening the hose nuts, hold the nuts on the hose side with a wrench using care not to twist the hose.

#### CAUTION:

Make sure that the front brake hoses are not twisted when the steering wheel is steered for the straight ahead direction.

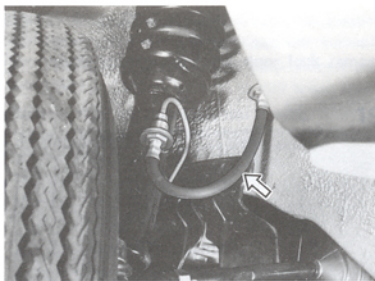


Fig. 18-49 Precautions on Reassembly and Adjustment

**CAUTION:**

After replacing any of the brake pipes or hoses, be sure carry out an air bleeding operation. You are duty-bound to do this before releasing the serviced machine to the user.

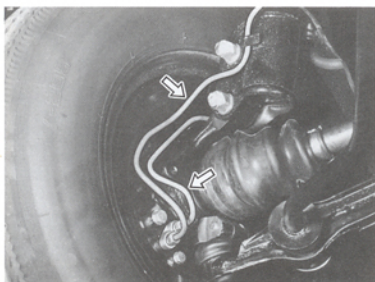


Fig. 18-50

## 18-13. Tightening Torque

Fastening parts	N.m (kg-m)	lb-ft
Brake bleeder plug (#10)	9 - 13 (0.9 - 1.3)	7.0 - 9.0
Tube union nut	15 - 18 (1.5 - 1.8)	11.0 - 13.0
Flexible hose nut	20 - 40 (2.0 - 4.0)	14.5 - 28.5
3-way joint bolt	8 - 10 (0.8 - 1.0)	5.5 - 7.0
Backing plate bolt	18 - 28 (1.8 - 2.8)	13.5 - 20.0
Proportioning & Bypass valve bolt	8 - 10 (0.8 - 1.0)	5.5 - 7.0
Wheel cylinder nut	7 - 11 (0.7 - 1.1)	5.0 - 8.0
Master cylinder nut	25 - 40 (2.5 - 4.0)	18.5 - 28.5

19-1. Description

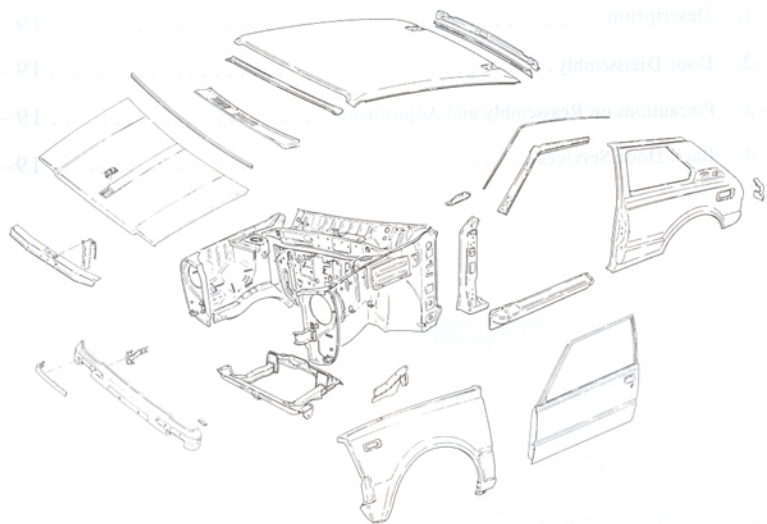


Fig. 19-1

## 19-2. Door Disassembly

Procedure for removing the door lock remote control.

Remove door-window regulator handle.

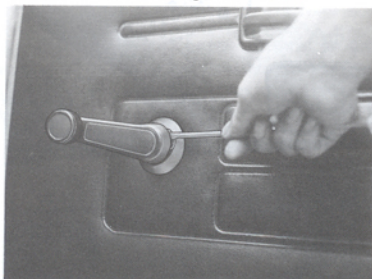


Fig. 19-2

Remove inside handle case.



Fig. 19-3

Remove rest arm.

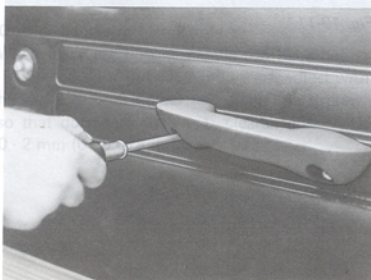


Fig. 19-4

Remove the door trim fastening clips from the top and sides. Withdraw the trim fitted on the lower part of the door.



Fig. 19-5

Remove the door water proof film.

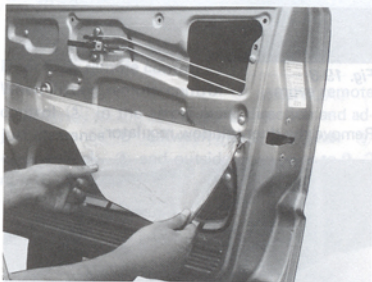


Fig. 19-6

Remove the door lock remote control. Open the end of the rod pin ② in the arrow mark ③ direction, then the control rod ① can be easily taken off.

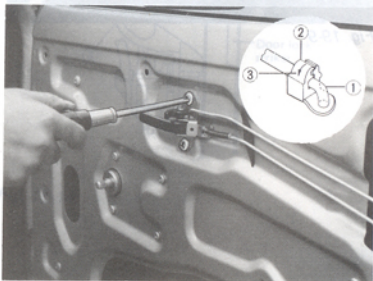


Fig. 19-7



Procedure for removing the door window regulator.

Remove the door-window regulator handle, inside handle case, rest arm, door trim and door water proof film as shown Fig. 19-2 – 19-6.

And then supporting the door glass by hand, remove two screws securing the door glass bottom channel.

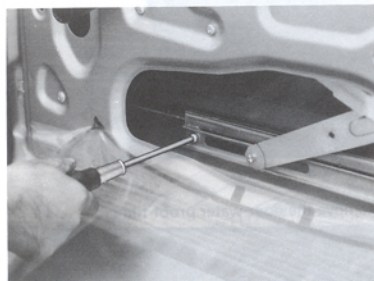


Fig. 19-8

Remove the door window regulator.

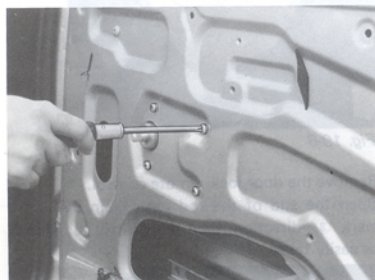


Fig. 19-9

Procedure for removing the door glass.

Remove the door window regulator handle, inside handle case, rest arm, door trim and door water proof film as shown Fig. 19-2 – 19-6.

Remove the door outside and inside scrape.



Fig. 19-10

Supporting the door glass by hand, remove two screws securing the door glass bottom channel, and remove the door glass.

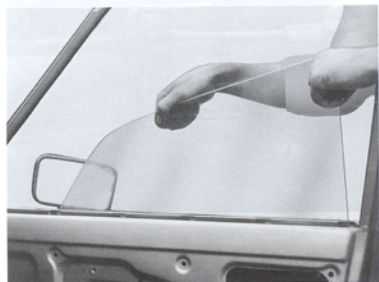
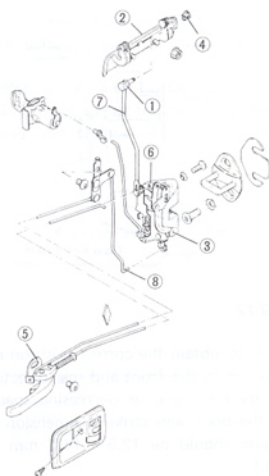


Fig. 19-11

### 19-3. Precautions on Reassembly and Adjustment



- ① Outside handle rod No.2 holder
- ② Door outside handle
- ③ Door lock Ass'y
- ④ Outside handle rod No.1 holder
- ⑤ Door lock remote control
- ⑥ Door lock rod pin
- ⑦ Door outside rod
- ⑧ Door safety lock rod

Fig. 19-12

#### Outside handle rod No.2 holder

When installing outside handle rod No.2 holder ① on the door outside handle ②, adjust with handle rod No.2 holder ① fitting part(screw) so that door lock ass'y ③ clearance at "A" is 0 - 2 mm (0 - 0.078 in.).

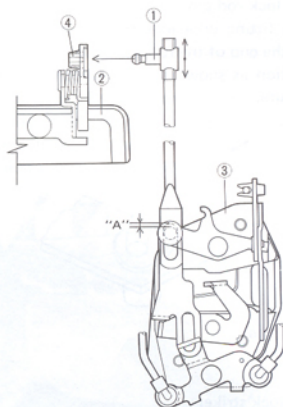


Fig. 19-13

#### Door lock remote control

When fitting remote control ⑤, move remote control ⑤ in the arrow mark direction and adjust clearance "B" between inside open lever ⑨ of door lock ③ and outside open lever to 0 - 2 mm (0 - 0.078 in.).

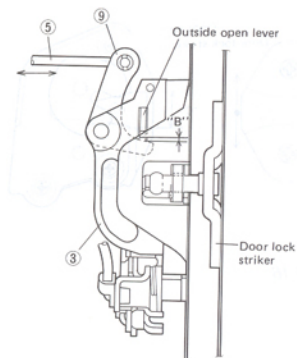


Fig. 19-14

### Door lock rod pin

When fitting door lock rod pin ⑥ on the rod, turn the end of the rod pin ⑥ in the arrow mark direction as shown in Fig. 19-15 and close the aperture.

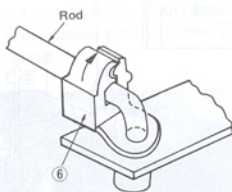


Fig. 19-15

### Door lock striker

Move the door lock striker up and down so that its center aligns approximately with the center of groove "C" of the door lock base.

#### CAUTION:

- The striker should be placed vertically.
- Do not adjust the door lock.

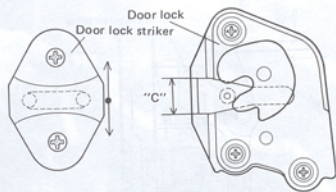


Fig. 19-16

Close the door and adjust by moving the door striker sideways so that the level difference between the door and the body is 0 mm (0 in.).

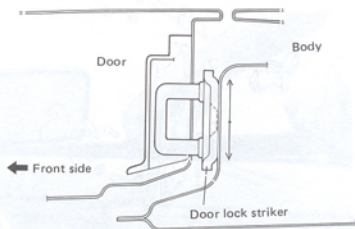


Fig. 19-17

In order to obtain the correct position of door lock striker in the front and rear direction, adjust it by increasing or decreasing spacers between the body and striker. Dimension "D" in the figure should be 12.6 - 14.6 mm (0.50 - 0.57 in.).

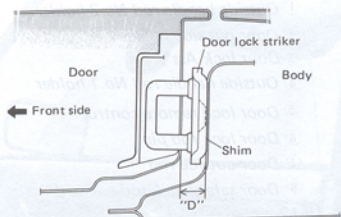


Fig. 19-18

#### NOTE:

Apply oil or grease to joints periodically.

### Door wind regulator and Door wind glass

Assemble the regulator in the following procedure.

- 1) Fit the glass bottom channel on the door wind glass.

When fitting the glass bottom channel on the door wind glass, adjust the distance between the glass end and channel end to that indicated below.

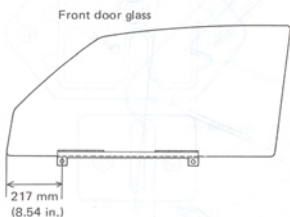


Fig. 19-19

- 2) Install the regulator on the door panel with screws.
- 3) Insert the door glass into the door panel, install the glass bottom channel to the regulator.

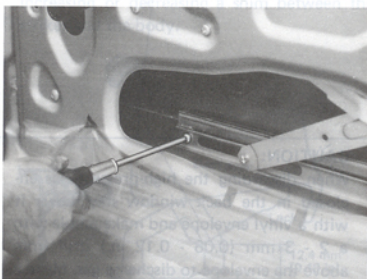


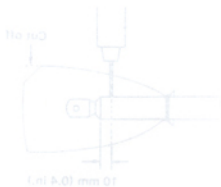
Fig. 19-20

### Door water proof film

A proof film that is broken a little may be mended with vinyl tape but should be replaced with polyethylene film as a rule. Apply bonding agent all around the circumference and stick on from the underside. Be careful to avoid wrinkles or gaps in bonding agent which may allow rain to leak in.



Fig. 19-21





## 19-4. Back Window Services

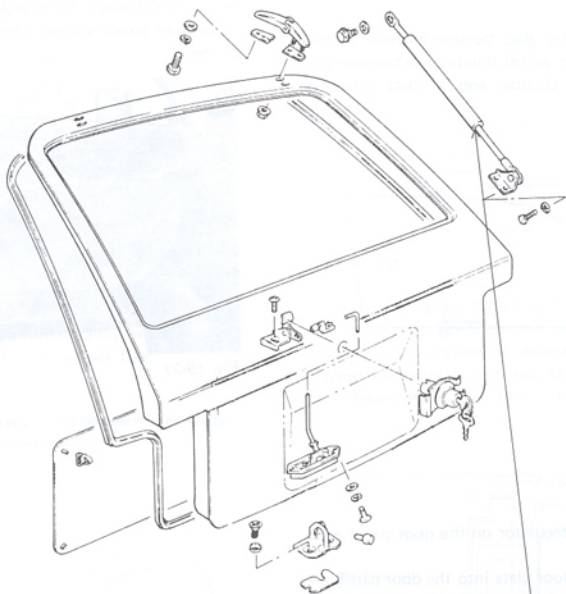


Fig. 19-22

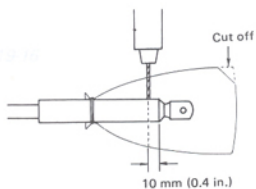


Fig. 19-22-1

**CAUTION:**

When discarding the high-pressure gas enclosed in the back window stay, cover it with a vinyl envelope and make a hole with a 2 - 3 mm (0.08 - 0.12 in.) drill from above the envelope to discharge gas. Make a 10 mm(0.4 in.) hole in the vinyl envelope beforehand.



When the door doesn't open or close smoothly despite that the door hinge or door are not distorted or deformed, carry out the following adjustment.

#### Back door striker

Move the back door striker to the right or the left and fit it in the center of groove width "A" of the back door lock base.

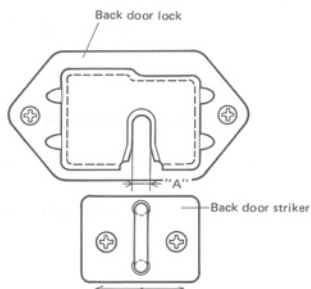


Fig. 19-23

- Close the back door and adjust by moving the back door striker to the front or the rear so that the level difference between the door and the body is 0 mm.
- When the back door lock is advanced into the striker as shown in Fig. 19-24, adjust the clearance between the door lock and the striker so as to be 12.4 mm (0.49 in.) by increasing or decreasing a shim between the striker and the body.

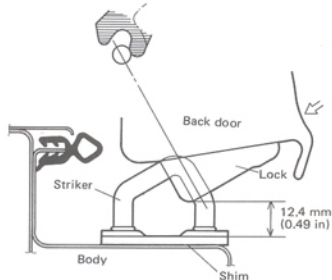


Fig. 19-24

After fitting the rod onto the back door lock link, lock the key cylinder and move the lock link up and down so that the clearance "C" between the link and the key cylinder is adjusted to be 2 mm (0.078 in.).

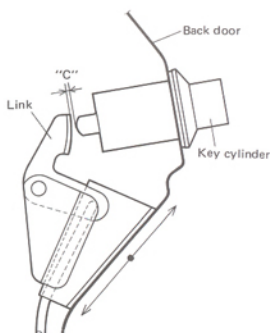
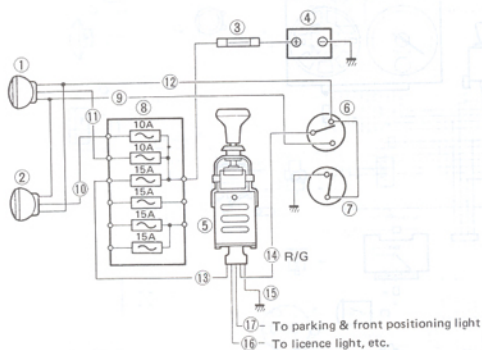


Fig. 19-25

## 20-2. Headlight

### Wiring circuit



- |                     |                    |                  |
|---------------------|--------------------|------------------|
| 1. Right head light | 2. Left head light | 3. Main fuse     |
| 4. Battery          | 5. Lighting switch | 6. Dimmer switch |
| 7. Passing switch   | 8. Fuse box        | 9. Red/white     |
| 10. White/blue      | 11. White/red      | 12. Red          |
| 13. White           | 14. Red/green      | 15. Black        |
| 16. Red/yellow      | 17. Red/blue       |                  |

Fig. 20-2

WIRE COLOR	WIRE COLOR	WIRE COLOR	WIRE COLOR
1. Right head light	2. Left head light	3. Main fuse	4. Battery
5. Lighting switch	6. Dimmer switch	7. Passing switch	8. Fuse box
9. Red/white	10. White/blue	11. White/red	12. Red
13. White	14. Red/green	15. Black	16. Red/yellow
17. Red/blue			

Fig. 20-1

### Headlight inspection

1. Lighting (Low beam, High beam, Passing)
2. Mounting
3. Dirt and cracks on lenses
4. Main beam axis direction and brightness

### Headlight beam setting (standard)

Before measuring or adjusting the headlight beam, adjust air pressure of the 4 tires to the specified value and settle the attitude of the vehicle by manually moving it up and down, then move the vehicle onto a flat surface. There are various measuring methods (e.g. screen method, using focusing type tester, etc.). The method described in this manual does not use a tester.

#### (1) Vertical beam alignment

Unless otherwise prescribed by the local statutory regulations, check the headlight beam setting according to the following procedure.

Set a blank wall 10 m (32.8 ft) in front of the vehicle and check if the hot spot (or high intensity zone) of the main beam axis (high beam) falls within the range between the headlight height ("H") and  $1/5$  of the headlight height below it as shown in Fig. 20-3.

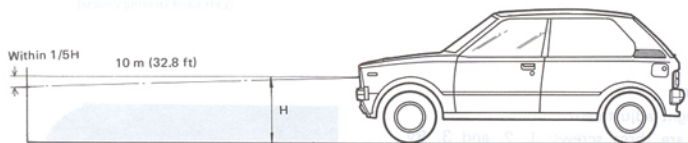


Fig. 20-3

(2) Horizontal beam alignment

Check if the hot spots of the main beam (high beam) strike within the ranges given in Fig. 20-4.

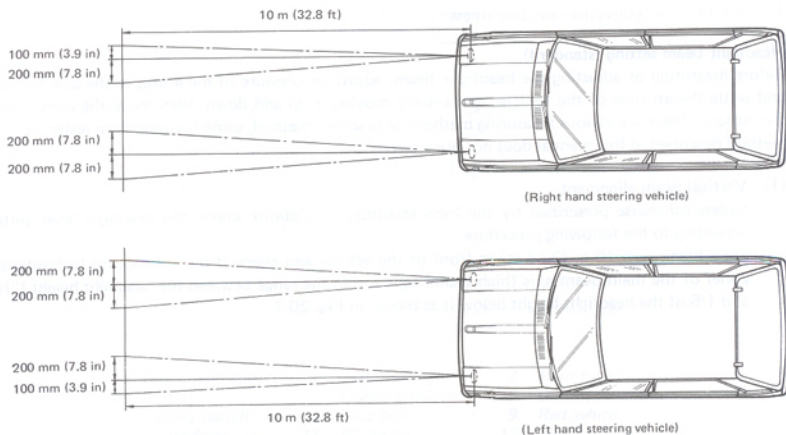


Fig. 20-4

**Maintenance**

(1) Head light adjustment

There are three screws; 1, 2, and 3. By means of these screws, adjust the light position for beam alignment.



Fig. 20-5

(2) Headlight dimmer switch

Check continuity between terminals with a circuit tester after turning on the head light switch: At LOW BEAM, continuity must be obtained between Red/green and Red/white terminals.

At HIGH BEAM, continuity must be obtained between White and Red terminals.

High beam	○	○	
Low beam	○	○	
	Red/green	Red/white	Red

Headlight dimmer switch

ON	○	○
OFF		
	White	Red

Fig. 20-6-1 Passing light switch

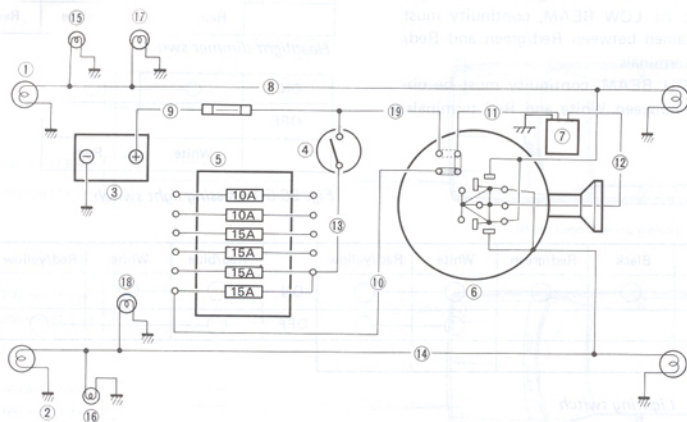
	Black	Red/green	White	Red/yellow		Red/blue	White	Red/yellow
II	○	○	○	○	ON	○	○	
I			○	○	OFF	○		○
OFF								

Fig. 20-6-2 Lighting switch



## 20-3. Turn Signal Light and Hazard Warning Light

### Circuit description



- |                                       |                              |                                |
|---------------------------------------|------------------------------|--------------------------------|
| 1. Right turn signal                  | 2. Left turn signal          | 3. Battery                     |
| 4. Main switch                        | 5. Fuse box                  | 6. Turn signal & dimmer switch |
| 7. Turn signal & Hazard warning relay | 8. Green/yellow              | 9. White                       |
| 10. Yellow                            | 11. Yellow/blue              | 12. Green                      |
| 13. Black/white                       | 14. Green/red                | 15. Meter pilot light (Right)  |
| 16. Meter pilot light (Left)          | 17. Side turn signal (Right) | 18. Side turn signal (Left)    |
| 19. White/Blue                        |                              |                                |

Fig. 20-7

When the Hazard warning Switch is "OFF".  
Yellow lead ⑩ is connected to Yellow/blue lead ⑪ .

When the Hazard warning Switch is "ON".  
White/blue lead ⑲ is connected to Yellow/blue lead ⑪ , and Green lead ⑫ to both Green/yellow lead ⑧ , and Green/red lead ⑭ .

When the Turn-signal Switch is "ON" for a right turn, green lead ⑫ is connected to Green/yellow lead ⑧ .

When the Turn-signal Switch is "ON" for a left turn, green lead ⑫ is connected to Green/red lead ⑭ .

## Switch inspection

Check continuity between the following terminals using a circuit tester.

Hazard warning	Turn signal	Green/Red	Green	Green/Yellow	Yellow	Yellow/Blue	White/blue
ON		○	○	○			
OFF	Left	○	○				
	Neutral				○	○	
	Right		○	○	○	○	

Fig. 20-8 Turn signal & Hazard warning switch

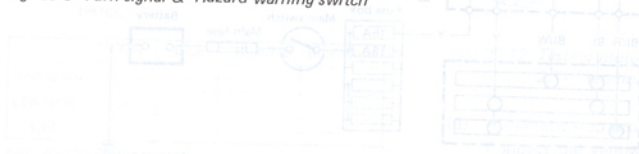


Fig. 20-7 Hazard warning switch



Fig. 20-11 Hazard warning switch

When the hazard warning switch is turned ON, the battery current flows through the fuse and the hazard warning switch to the hazard warning lamps. When the hazard warning switch is turned OFF, the current will automatically return to the battery.

The switch is designed so that when the Wiper Switch is turned ON, current is applied to the Wiper Motor from the battery, the motor rotates and the blades move. The gear mechanism which converts rotational movement of the motor into swinging movement of the blade has a cam on the final gear shaft. The cam switches the contacts of P1 and P2 every revolution. At the blade stop position, the contact is switched from P2 to P1.

Reversed contact making and breaking is independent of the wiper motor rotation. When the Wiper Switch is turned OFF, while the blade is in a position other than the last position, motor current path is changed to the SWW motor. Therefore, the motor will return to the last position of wiper and the wiper switch is turned OFF, and the blade will return to the last position of wiper and motor current.

When the blade returns to the rest position, the cam contact is changed from P2 to P1 and motor current is shut off. When supply to the motor is cut off, a counter electromotive force is generated in the motor. As a result of this back e.m.f., current flows through the motor and shunt circuit and the wiper stops and the wiper blades stay in the specified position.

3. Put a jumper

Blue/white and

## 20-4. Windshield Wiper Motor

### Circuit description

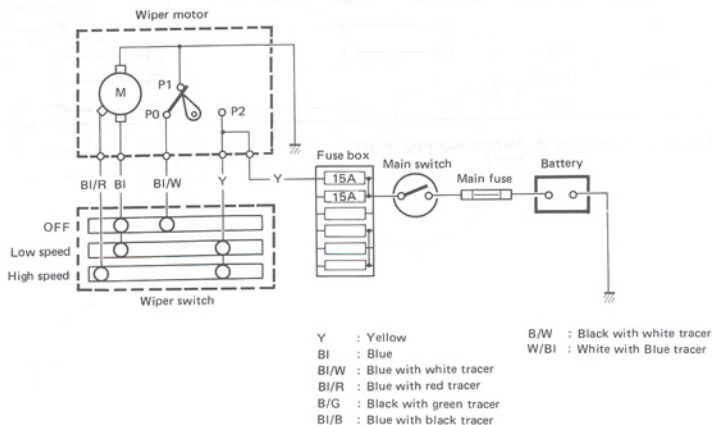


Fig. 20-9

The circuit is designed so that, when the Wiper Switch is turned "OFF", the blade will automatically return to the horizontal position. In Fig. 20-9, when the Wiper Switch is turned "ON" while the Main Switch is "ON", current is supplied to the Wiper Motor from the Battery, the motor rotates and the blade moves. The gear mechanism which converts rotational movement of the motor into swinging movement of the blade has a cam on the final gear shaft. The cam switches the contacts of P0 and P2 every revolution. (At the blade stop position, the contact is switched from P2 to P1).

Repeated contact making and breaking is independent of the wiper motor rotation. When the Wiper Switch is turned "OFF" while the blade is in a position other than the rest position, motor current path is changed (i.e. BI/W  $\rightarrow$  BI  $\rightarrow$  Motor). Therefore, the motor keeps rotating even though the wiper switch is turned "OFF", and the blade will return to the rest position.

When the blade returns to the rest position, the cam contact is changed from P2 to P1 and motor current is shunted. When supply to the motor is cut off, a counter electromotive force is generated in the armature. As a result of this back e.m.f., current flows through the motor and shunt circuit and the motor stops and the wiper blade stays in the specified position.

## Maintenance

### (1) Wiper trouble diagnosis

When the wiper motor does not start even if the Wiper Switch is turned "ON", check lead connections and coupler connections. Then, check the following items.

- Fuse blown or mounted incorrectly
- Wiper switch:

To check the wiper switch, remove the couplers and check continuity between the following terminals using a circuit tester.

	Yellow	Blue	Blue/red	Blue/white
High speed	○		○	
Low speed	○	○		
OFF		○		○

Fig. 20-10 Wiper switch

	Black/blue	Black
ON	○	○

Fig. 20-11 Washer switch

- Break in the wiper motor armature or poor commutator brush contact:

To check these, check continuity between the Blue lead and ground, and the Blue/red wire and ground.

### (2) No-load run test

As shown in Fig. 20-12, using a 12V battery, connect the "+" terminal to the Blue terminal and the "-" terminal to the motor. If the motor rotates at 47 - 57 r/min, this is acceptable (for Low-speed check). For High-speed check, connect the "+" terminal of the battery to the Blue/red terminal and the "-" to the motor. If the motor rotates at 73 - 83 r/min, this is acceptable.

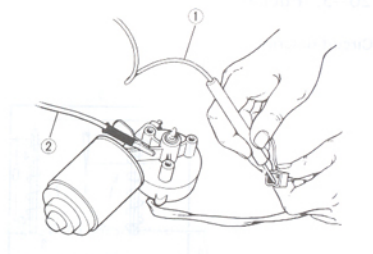


Fig. 20-12 Testing motor 1. "+" terminal 2. "-" terminal

### (3) Automatic stop action test

Connect the yellow terminal of the motor to the positive "+" battery terminal, and put a jumper between the Blue/white shaft and the Blue to see if the motor output shaft comes to a halt at a certain, not just any, angular position. That position corresponds to the starting position of the blade. Using the jumper, stop the motor a number of times to make sure that the motor stops at the same position each time.

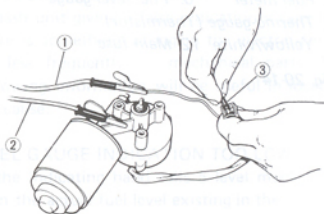


Fig. 20-13 Testing motor  
1. "+" terminal 2. "-" terminal  
3. Put a jumper between Blue/white and Blue

## 20-5. Fuel and Water Temperature Gauge

### Circuit description

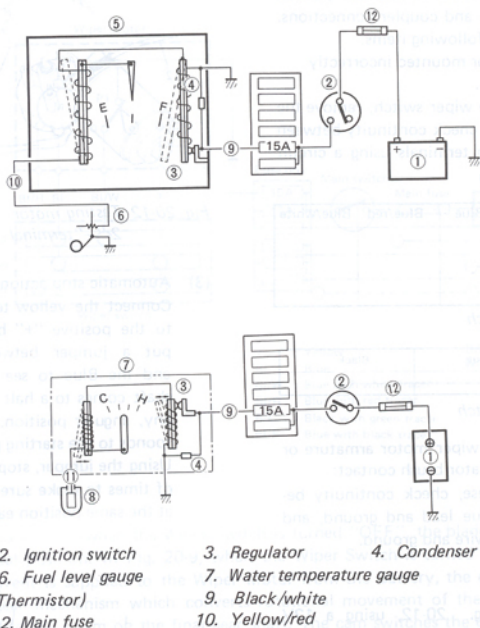


Fig. 20-14



The Fuel Gauge and Water Temperature Gauge circuit is shown in Fig. 20-14. A regulator is provided so that the Fuel Gauge and Water Temperature Gauge indications are not changed by battery voltage variation. To prevent the point surface being damaged by fire, and prevent noise, a condenser is provided on the regulator.

#### Fuel Gauge operation

The Fuel Gauge is resistor type using a bimetal strip. The resistance of the fuel level gauge (which includes a sliding resistor) varies according to the amount of fuel in the fuel tank. Current flowing through the heating coil changes in proportion to change in the resistance and flexion of the bimetal strip also changes, i.e., as the amount of fuel decreases, the fuel level gauge resistance increases, current decreases, and flexion of the bimetal strip decreases, and the change is registered on the meter. When the fuel is large, the flexion of the bimetal strip is large, with a correspondingly large indication on the meter.

#### Water temperature gauge operation

The Water Temperature Gauge which detects the water temperature in the engine is a resistor type using a bimetal strip. The thermo-gauge, with a built-in thermistor, is mounted on the inlet manifold. Thermistor resistance decreases as the temperature increases. A heating wire is wound around the bimetal strip, so that the bimetal flexes according to the current through the heating wire. As the water temperature increases, resistance of the thermo-gauge is lowered, current increases, flexion of the bimetal strip increases, and the meter indication rises.

#### Inspection

##### FUEL GAUGE TANK UNIT

This tank unit is to be tested to see how its variable resistor changes its effective resistance value for a change in fuel level. With a resistance meter connected to the tank unit as shown, move the lever from "empty" position to "full" position. If the resistance indicated by the meter changes in a manner approximating the curve shown in the following graph, the tank unit is in sound condition:

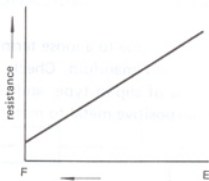


Fig. 20-15 Resistance-fuel level relationship

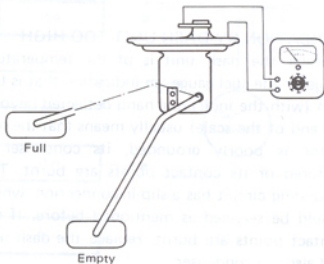


Fig. 20-16 Checking tank unit

#### TROUBLE SHOOTING GUIDE

A dash unit giving a false indication means that there is something wrong in the electric circuit or, less frequently, in mechanical parts. The following information will be useful in locating the cause:

##### FUEL GAUGE INDICATION TOO LOW

If the indicating hand tells a level much lower than the actual fuel level existing in the tank, the most likely cause is a defective ground connection of the dash unit or of the fuel tank. Undo the grounding connection, polish the mating faces with sandpaper, and tighten the connection fully to ensure the metal-to-metal contact. This will remedy the trouble; if it will not, then check the terminal connections of the circuit.

## TEMPERATURE GAUGE INDICATION TOO LOW

This trouble is often due to a loose terminal connection on the inlet manifold. Check the connection, which is of slip-in type, and repair the fittings to obtain positive metal-to-metal contact.

### NOTE:

Bear in mind that, at the time of starting up a cold engine, the water temperature gauge could be giving a true indication while the engine itself is extremely cold.

## INDICATION BY DASH UNIT TOO HIGH

Whether the dash unit is of the temperature gauge or the fuel gauge, an indication that is too high (with the indicating hand deflected beyond the end of the scale) usually means that the regulator is poorly grounded, its condenser is ruptured or its contact points are burnt. The grounding circuit has a slip-in connection, which should be serviced as mentioned before. If the contact points are burnt, replace the dash unit and also the condenser.

Where the dash unit is of the fuel gauge, it is possible that the actuating arm on its tank unit is stuck in the position for high level.

### NOTE:

If the parts mentioned above are found to be in sound condition, then the false indication means that the cause is within the dash unit, tank unit or engine unit, and, in such a case, the unit blamed must be replaced.

## 20-6. Fuse Box

The fuse Box is wired as follows.

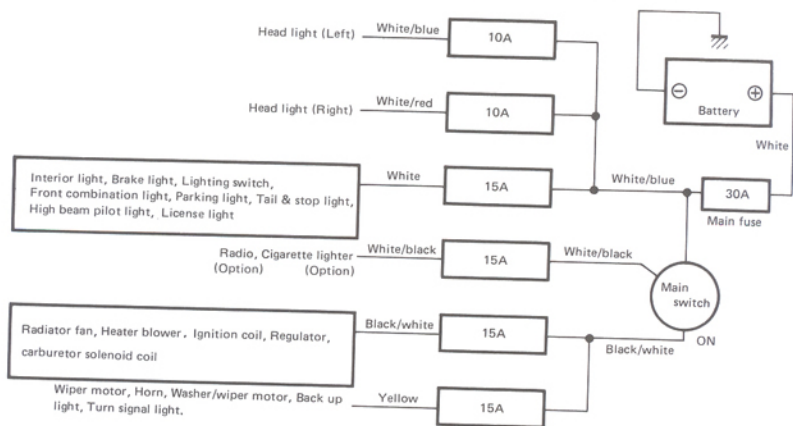


Fig. 20-17

## 21-1. Periodical Inspection Schedule

A machine is in the best operable condition at all times where it is systematically inspected, re-adjusted, re-lubricated and serviced at regular intervals. Such a machine is safe to use and works to the best of its ability. The following schedule has been carefully formulated for the machines, with a view to attaining what the above concept implies:

Interval:	km (x 1,000)	1	10	20	30	40	50	60	70	80
This interval should be judged by odometer reading or months, whichever comes first.	miles (x 1,000)	1	6	12	18	24	30	36	42	48
	months	1	6	12	18	24	30	36	42	48
<b>ENGINE</b>										
1. Water pump (fan) drive belt (tension, wear, etc.)		A	-	I	-	R	-	I	-	R
2. Camshaft timing belt (damage, wear)		I	-	I	-	I	-	I	-	I
3. Valve clearance		A	-	A	-	A	-	A	-	A
4. Engine bolts (All cylinder head and manifold fixings)		T	-	T	-	T	-	T	-	T
5. Engine oil filter		R	R	R	R	R	R	R	R	R
6. Engine oil	API Grade SD or SE	R	Replace every 10,000 km (6,000 miles)							
	API Grade SC	R	Replace every 5,000 km (3,000 miles)							
7. Engine coolant		-	-	-	-	R	-	-	-	R
8. Cooling system hoses and connections (leakage, damage, etc)		-	-	I	-	I	-	I	-	I
9. Exhaust pipes and mountings (leakage, damage)		-	-	I	-	I	-	I	-	I
<b>IGNITION</b>										
10. Ignition wiring (damage, deterioration)		-	-	I	-	I	-	I	-	I
11. Distributor cap and rotor (wear, deterioration, etc.)		-	-	I	-	I	-	I	-	I
12. Spark plugs and distributor breaker point		-	R	R	R	R	R	R	R	R
13. Ignition timing		I	A	A	A	A	A	A	A	A
14. Distributor advance		-	-	I	-	I	-	I	-	I

"A" : Check and/or adjust if necessary      "T" : Tighten to the specified torque  
 "R" : Replace or Change                      "L" : Lubricate                      "C" : Clean  
 "I" : Inspect and correct or replace if necessary

Interval: This interval should be judged by odometer reading or months, whichever comes first.	km (x 1,000)	1	10	20	30	40	50	60	70	80
	miles (x 1,000)	1	6	12	18	24	30	36	42	48
	months	1	6	12	18	24	30	36	42	48
<b>FUEL</b>										
15. Air cleaner	Paved-road	Clean every 10,000 km (6,000 miles)								
	Dusty condition	Clean every 2,500 km (1,500 miles) or as required Replace every 40,000 km (24,000 miles) More frequent replacement if under dusty driving conditions.								
16. Accelerator cable & Carburetor shafts	-	I&L	I&L	I&L	I&L	I&L	I&L	I&L	I&L	I&L
17. Fuel tank cap, gas lines and connections <small>(leakage, damage)</small>	I	-	-	-	I	-	-	-	-	I
18. Fuel filter	-	C	C	C	R	C	C	C	C	R
19. Idle speed and idle mixture	A	-	A	-	A	-	A	-	A	-
<b>CRANKCASE EMISSION CONTROL</b>										
20. Crankcase ventilation hoses and connections	-	-	I	-	I	-	I	-	I	-
<b>FUEL EVAPORATIVE EMISSION CONTROL</b>										
21. Fuel vapor storage system, hoses and connections	-	-	I	-	I	-	I	-	I	-
<b>ELECTRICAL</b>										
22. Wiring harness connections and headlights	-	-	I	-	I	-	I	-	I	-
<b>CHASSIS AND BODY</b>										
23. Clutch pedal (play)	I	I	I	I	I	I	I	I	I	I
24. Brake fluid (level, leakage)	I	I	I	I	R	I	I	I	I	R
25. Brake pedal (pedal-to-wall clearance)	I	I	I	I	I	I	I	I	I	I
26. Brake lever and cable (play, damage)	I	I	I	I	I	I	I	I	I	I
27. Brake drums and shoes (wear)	-	I	I	I	I	I	I	I	I	I
28. Brake hoses and pipes (leakage, damage)	-	I	I	I	I	I	I	I	I	I
29. Tires (Abnormal wear and pressure, etc.)	-	I	I	I	I	I	I	I	I	I
30. Wheels and hub nuts (damage, tightness)	I	I	I	I	I	I	I	I	I	I
31. Shock absorbers (oil leakage, damage)	-	I	I	I	I	I	I	I	I	I
32. Drive shafts (damage)	-	-	I	-	I	-	I	-	I	-
33. Transmission and differential oil (level, leakage)	R	I	I	I	R	I	I	I	I	R



Interval: This interval should be judged by odometer reading or months, whichever comes first.	km (x 1,000)	1	10	20	30	40	50	60	70	80
	miles (x 1,000)	1	6	12	18	24	30	36	42	48
	months	1	6	12	18	24	30	36	42	48
34. Bolts and nuts (tightness)		T	—	T	—	T	—	T	—	T
35. Steering condition (play, tightness, breakage, etc.)		I	I	I	I	I	I	I	I	I
36. Test drive		Test drive on completion of each service								

"A" : Check and/or adjust if necessary      "T" : Tighten to the specified torque

"R" : Replace or Change                      "L" : Lubricate                      "C" : Clean

"I" : Inspect and correct or replace if necessary

33. Transmission and differential oil (level, leakage)		R	I	I	I	I	I	R	I	I	R
32. Drive shafts (damage)		I	—	I	—	I	—	I	—	I	—
31. Shock absorbers (oil leakage, damage)		I	—	I	—	I	—	I	—	I	—
30. Wheels and hub nuts (damage, rust, uneven wear)		I	—	I	—	I	—	I	—	I	—
29. Tires (Abnormal wear and pressure, etc.)		I	—	I	—	I	—	I	—	I	—
28. Brake hoses and pipes (leakage, damage)		I	—	I	—	I	—	I	—	I	—
27. Brake drums and shoes (wear)		I	—	I	—	I	—	I	—	I	—
26. Brake lever and cable (play, damage)		I	—	I	—	I	—	I	—	I	—
25. Brake pedal (pedal-to-wall clearance)		I	—	I	—	I	—	I	—	I	—
24. Brake fluid (level, leakage)		I	—	I	—	I	—	I	—	I	—
23. Clutch pedal (play)		I	—	I	—	I	—	I	—	I	—
CHASSIS AND BODY											
ELECTRICAL											
32. Wiring harness connections and headlamps		I	I	I	I	I	I	I	I	I	I
31. Fuel vapor storage system, hoses and connections		I	I	I	I	I	I	I	I	I	I
30. Crankcase ventilation hoses and connections		I	I	I	I	I	I	I	I	I	I
DRYBULB CASE EMISSION CONTROL											
FUEL EVAPORATIVE EMISSION CONTROL											
ACCELERATOR AND FUEL MIXTURE											

## 22-1. MODIFICATIONS

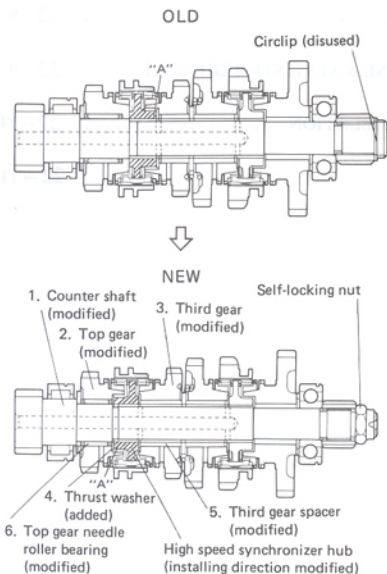
Pages 22-2 to 22-6 contain those modifications which have been carried out on and after the following body number. Note that the applicable vehicles are subject to the modified installation, adjustment and measurement described in this section instead of those in the main text of this book.

Body No. SS40V-107001

Hereinafter the vehicles before the above body number are referred to as "OLD" and those of and after the same number as "NEW".

### TRANSMISSION

The modified transmission parts are as shown below. Special care must be used as to the installing direction of the high-speed synchronizer hub (be careful which way to direct its longer boss "A").



[Method of mounting the self-locking nut]

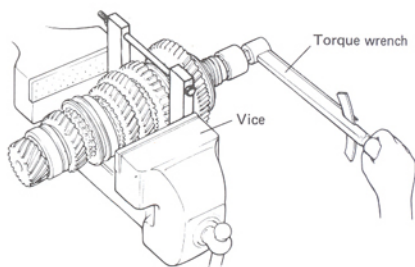
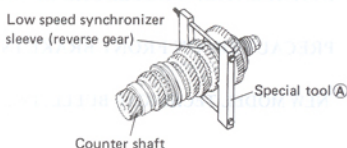
#### NOTE:

Use the special tool (A) (Parts No. 09921-57810) when loosening or tightening the self-locking nut.

1. Fit the special tool (A) on the low speed synchronizer sleeve and fix it securely with a vice as shown below. And then tighten the self-locking nut to the below specified tightening torque.

Tightening torque  
for self-locking nut

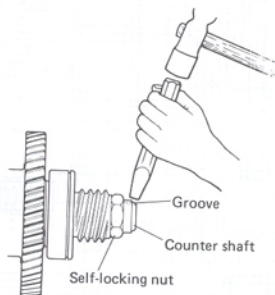
60 ~ 80 N·m  
6.0 ~ 8.0 kg·m  
43.5 ~ 57.5 lb·ft



2. In order to lock the self-locking nut firmly, caulk the nut with a chisel or the like as its part over the groove in the counter shaft, as shown below.

**NOTE:**

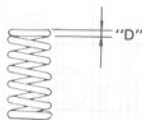
The self-locking nut once used should never be used again.



**ENGINE (Valve spring)**

Wire diameter "D" of the engine valve spring was modified from 4.2 mm (0.17 in) to 4.0 mm (0.16 in). In consequence of this, the service data given on p. 4-23 of the main text were modified as given below.

But the new and old engine valve spring are interchangeable.



**NEW**

Item	Standard	Limit
Valve spring free length	48.9 mm (1.9252 in)	47.6 mm (1.8740 in)
Valve spring preload	23.6 ~ 27.6 kg for 40 mm (52.0 ~ 60.8 lb/1.57 in)	22.0 kg for 40 mm (48.5 lb/1.57 in)

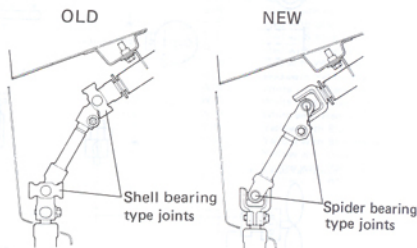
**STEERING**

The steering shaft joint was structurally modified from the shell bearing type to the spider bearing type.

**NOTE:**

Precautions for installation remain the same.

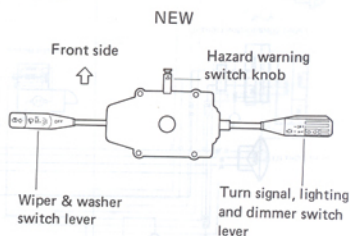
Make sure not to use a shell bearing type joint together with a spider bearing type joint.



**ELECTRICAL**

**Combination switch**

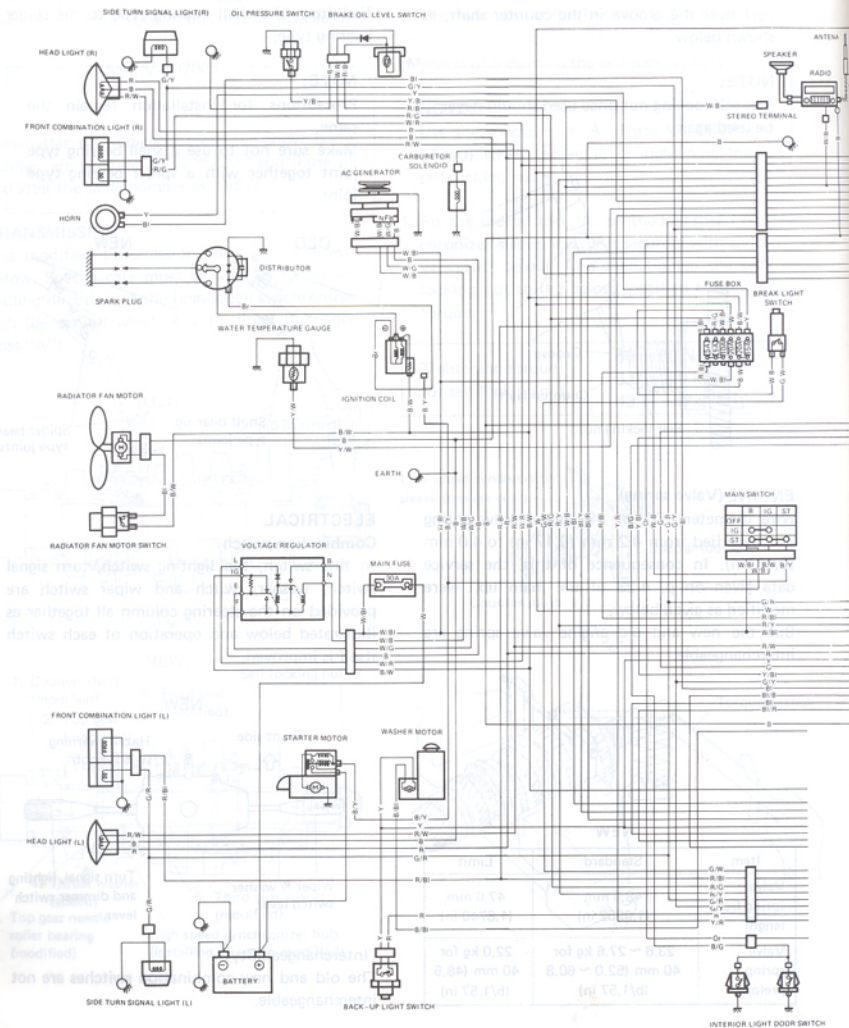
In this switch, the lighting switch, turn signal switch, washer switch and wiper switch are provided on the steering column all together as illustrated below and operation of each switch itself is improved.



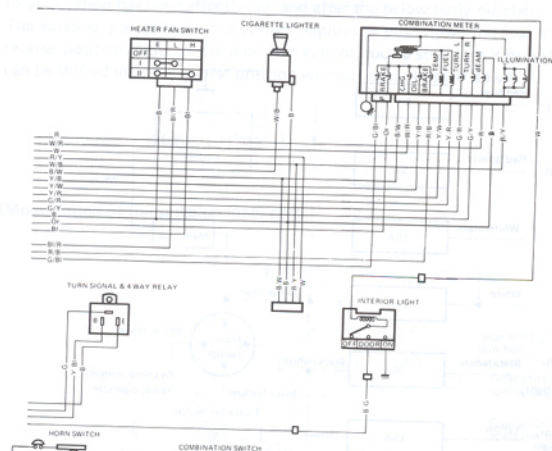
**[Interchangeability]**

The old and new combination switches are not interchangeable.

# WIRING DIAGRAM

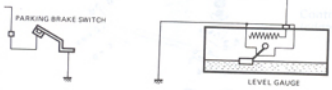
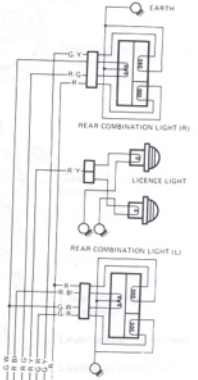
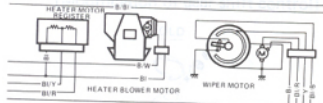
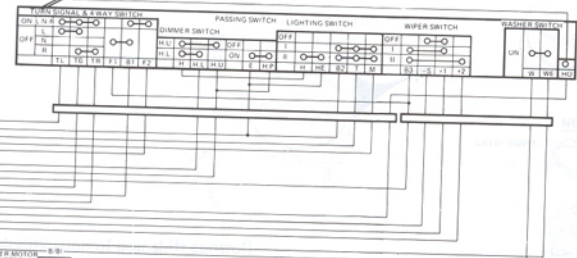






**WIRE COLOR**

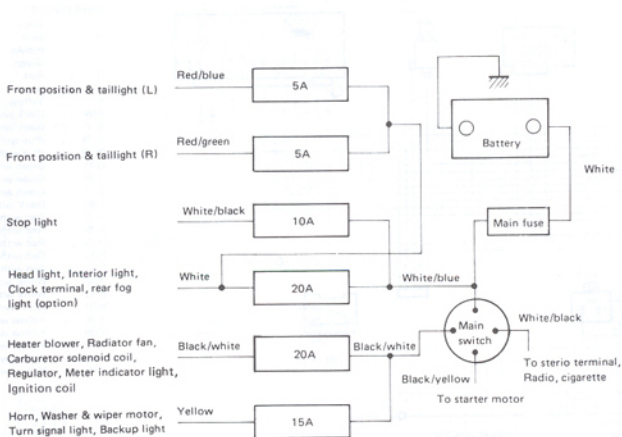
B . . . . .	Black
Bl . . . . .	Blue
Br . . . . .	Brown
G . . . . .	Green
R . . . . .	Red
W . . . . .	White
Y . . . . .	Yellow
B/W . . . . .	Black with White tracer
B/Y . . . . .	Black with Yellow tracer
Bl/R . . . . .	Blue with Red tracer
Bl/W . . . . .	Blue with White tracer
G/R . . . . .	Green with Red tracer
G/Y . . . . .	Green with Yellow tracer
G/W . . . . .	Green with White tracer
G/Y . . . . .	Green with Yellow tracer
B/Bl . . . . .	Black with Blue tracer
R/B . . . . .	Red with Black tracer
R/Bl . . . . .	Red with Blue tracer
R/G . . . . .	Red with Green tracer
R/W . . . . .	Red with White tracer
R/Y . . . . .	Red with Yellow tracer
W/B . . . . .	White with Black tracer
W/G . . . . .	White with Green tracer
W/R . . . . .	White with Red tracer
Y/B . . . . .	Yellow with Blue tracer
Y/G . . . . .	Yellow with Green tracer
Y/R . . . . .	Yellow with Red tracer
Y/W . . . . .	Yellow with White tracer





## FUSE BOX

The fuses and their circuits given on P.20 — 15 of the main text were modified as given below.



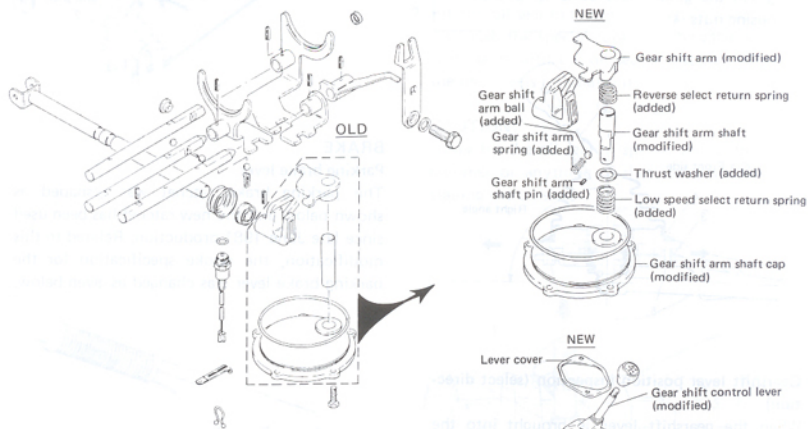
## TRANSMISSION & GEAR SHIFT CONTROL SYSTEM

A structural modification was carried out on the transmission and gear shift control system as follows, and its application has been effective on and after the below body number.

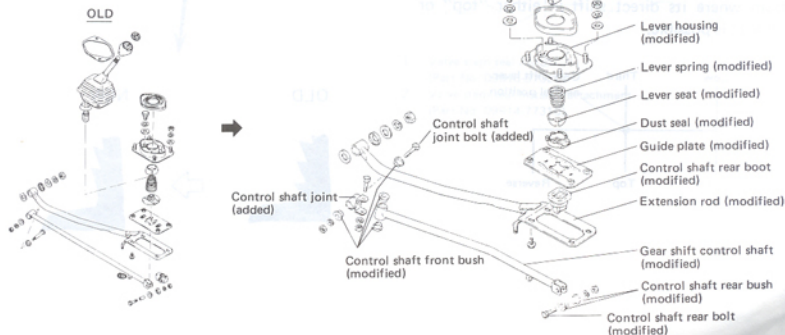
The existing gear shift control system requires to push down the gear shift control lever to shift it into the reverse position. Now in the modified system, such a structure is provided that the gear shift control lever can be shifted into the reverse position without being pushed down.

Body No. SS40V-101322

### [Modification of transmission inner parts]



### [Modification of gear shift control]



## Maintenance Services for New System

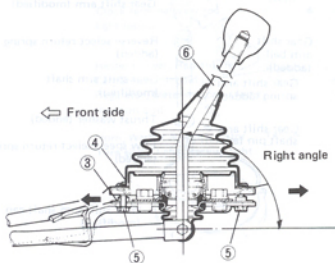
### Gear shift lever adjustment

[When each shift stroke is short (when gears are not in complete mesh)]

Loosen gearshift control lever housing nuts ④ and guide plate bolts ⑤. Adjust the guide plate ③ by displacing it toward front and rear so that gearshift control lever ⑥ is brought in the middle of the guide plate and at the right angle.

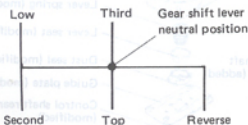
#### NOTE:

Once guide plate ③ is positioned properly, tighten the guide plate bolts ⑤ and then housing nuts ④.

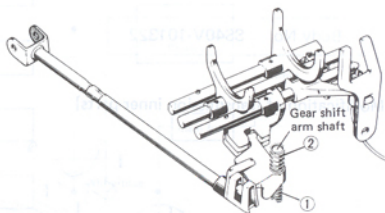


### Gearshift lever position inspection (select direction)

When the gearshift lever is brought into the neutral position, it should be in such a position along the lever select direction, as shown below, from where its direct shift in either "top" or "third" is possible.



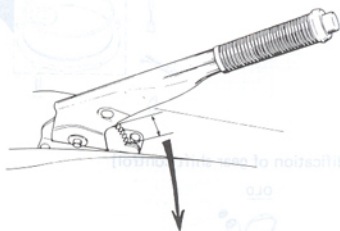
If the gearshift lever is out of the above specified position, check the gearshift control shaft joint bushes for wear. If the bushes are free from wear and the gearshift lever is still out of the position where it should be, check the low speed select return spring ① or reverse select return spring ② for deterioration.



## BRAKE

### Parking brake lever

The parking brake ratchet was reshaped as shown below and the new ratchet has been used since late June 1981 production. Related to this modification, the stroke specification for the parking brake lever was changed as given below.



OLD

NEW



Parking brake lever stroke	OLD	NEW
	6 notches max.	within 3 ~ 4 notches

**NOTE:**

Also when adjusting the stroke of the old parking brake lever, adjust it close to the newly specified stroke.

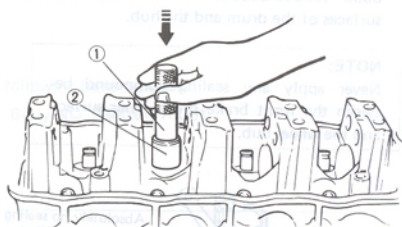
## 22-2. INSTALLATION PROCEDURE OF ENGINE VALVE STEM OIL SEAL

Indiscriminate or incorrect installation of the valve stem oil seal causes increase in engine oil consumption. Therefore, the following instructions must be observed very carefully.

1. Don't reuse the oil seal once removed. It must be replaced with a new one.
2. Before installing the oil seal, check to ensure that the special tool and the valve guide are free from any dust and soak the oil seal in the oil.
3. Fit the oil seal to the special tools ① and ②, and push the special tool into the valve guide with hand until the oil seal is installed (when the hand feels installation).

**CAUTION:**

Never hit the oil seal or special tool with a hammer or anything of that sort while installing the oil seal.



- ① : Valve stem seal handle  
(Part No. 09916-57320)
- ② : Valve stem seal installer attachment  
(Part No. 09914-77310)

**MODIFICATION**

**NOTE:**

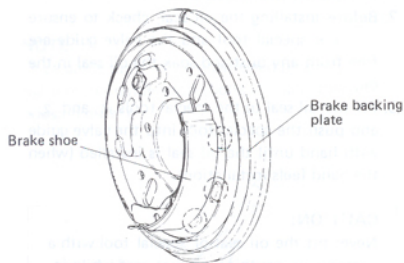
- Old or new part can be used for new or old model.
- Old or new part cannot be used for new or old model.

PARTS	MODIFICATION	INTERCHANGE
ENGINE	* Cars of 1991-92 equipped with engine valve timing modified as follows.	

### 22-3. PRECAUTION ON FRONT BRAKE INSTALLATION

When reassembling the front brake, be sure to carry out each step strictly as instructed here below as well as in the main text.

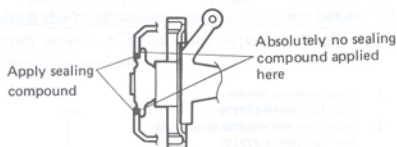
- Make sure that the brake shoe is in close contact with the backing plate at three portions as circled in the illustration.



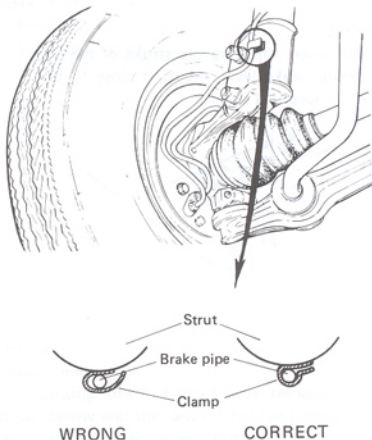
- When installing the front brake drum onto the wheel hub, apply SEALING COMPOUND 366E (99000-31090) to the outer mating surfaces of the drum and the hub.

#### NOTE:

Never apply any sealing compound between the front brake drum inner surface and the wheel hub.



- Make sure that the brake pipe on the front strut is securely clamped with a clamp as shown below.

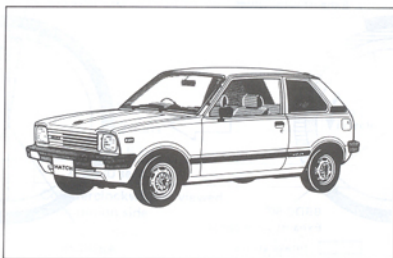




# NEW MODEL TECHNICAL BULLETIN

## SUZUKI HATCH with 550cc ENGINE

April, '83



In order to improve marketability and performance of the above models, modifications were carried out starting with '83 April production. They are on interior and exterior designs and engine, ignition system, transmission, steering, brake, electrical, car heater and fuel.

This bulletin is to provide descriptions of the modifications carried out on significant parts, their interchangeability and precautions to be taken in servicing.

For the new parts supply and parts numbers, refer to Parts Catalogue issued by Export Parts Section.

These modifications were carried out on and after the following body numbers.

Body NO. SS40V-270001

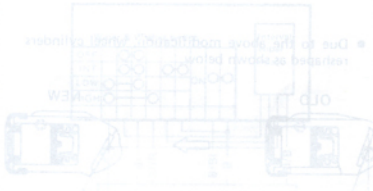
### MODIFICATION

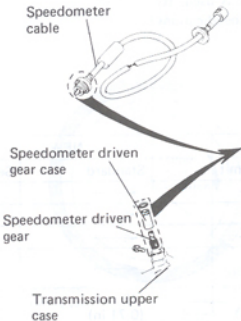
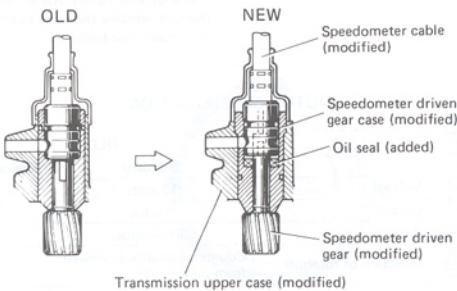
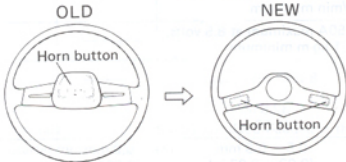
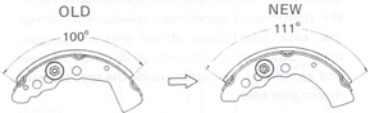

#### NOTE:

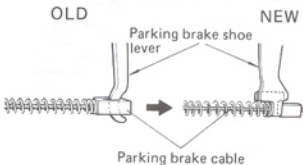



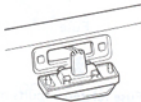



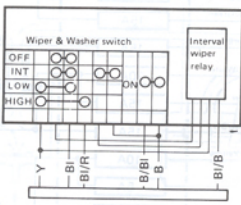

- ⊕→ : Old or new part can be used for new or old model in the direction as shown by the arrow.
- ✕→ : Old or new part cannot be used for new or old model in the direction as shown by the arrow.

PARTS		MODIFICATION	INTERCHANGEABILITY
ENGINE	Camshaft	<ul style="list-style-type: none"> <li>• Cams of camshaft reshaped and engine valve timing modified as follows.</li> </ul>	OLD ⊕→ NEW

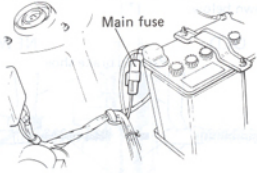

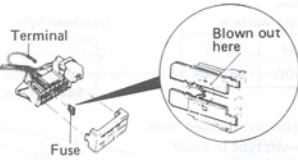


	PARTS	MODIFICATION	INTERCHANGEABILITY
ENGINE	<p><b>Valve timing diagram</b></p> <p>OLD TDC BTDC 12° Intake valve opens ATDC 10° Exhaust valve closes ABDC 48° Intake valve closes BDC BBDC 50° Exhaust valve opens</p> <p>NEW TDC BTDC 5° Intake valve opens ATDC 5° Exhaust valve closes ABDC 35° Intake valve closes BDC BBDC 35° Exhaust valve opens</p> <p>Direction of rotation</p> <p>Legend: Intake stroke Compression stroke Power stroke Exhaust stroke</p>		
STARTER MOTOR & IGNITION SYSTEM	<p><b>Ignition coil</b></p> <ul style="list-style-type: none"> <li>Terminal added for bypass circuit.</li> </ul> <p><b>Starter motor</b></p> <ul style="list-style-type: none"> <li>Contact point "A" of the bypass circuit added in the starter motor magnet switch.</li> </ul> <p><b>IGNITION CIRCUIT</b></p>	<p>OLD  NEW </p> <p>OLD  NEW </p>	

PARTS		MODIFICATION		INTERCHANGEABILITY			
STARTER MOTOR & IGNITION SYSTEM	<ul style="list-style-type: none"> <li>A smaller and lighter starter motor is used. Its structure remains the same but the specifications were changed as follows.</li> </ul>						
	STARTER MOTOR SPECIFICATION						
	ITEM	OLD			NEW		
		Standard	Service Limit	Standard	Service Limit		
	Voltage	12 volts	—	←	—		
	Output	0.6 kw	—	←	—		
	Rating	30 seconds	—	←	—		
	Direction of rotation	Counterclockwise as viewed from pinion side	—	←	—		
	Brush length	19 mm (0.75 in)	12 mm (0.47 in)	18 mm (0.71 in)	11.5 mm (0.45 in)		
	Number of pinion teeth	9	—	8	—		
	No-load characteristic	55A maximum at 11 volts, 3 500 r/min minimum	—	50A maximum at 11 volts, 5 000 r/min minimum	—		
	Load characteristic	230A maximum at 9.5 volts, and 0.5 kg-m torque, 1200 r/min minimum	—	←	—		
	Locked rotor current	450A maximum at 8.5 volts, 1.1 kg-m minimum	—	←	—		
Magnetic switch operating voltage	8 volts maximum	—	←	—			
Commutator diameter	32.5 mm (1.28 in)	—	28 mm (1.10 in)	—			
Mica undercut	0.5 – 0.8 mm (0.02 – 0.03 in)	0.2 mm (0.007 in)	←	←			
TRANSMISSION	Transmission upper case Speedometer driven gear case Speedometer driven gear Speedometer cable	<ul style="list-style-type: none"> <li>To obtain better sealing at the joint between the speedometer driven gear and speedometer cable, the transmission upper case, speedometer driven gear case, speedometer driven gear and speedometer cable were reshaped as illustrated below and an oil seal was added inside the speedometer driven gear case.</li> </ul> 			The old and new parts are interchangeable only when they are replaced in a set as given below. <p style="text-align: center;"><b>OLD PARTS</b></p> <ul style="list-style-type: none"> <li>Transmission upper case</li> <li>Driven gear case</li> <li>Driven gear</li> <li>Speedometer cable</li> </ul> <p style="text-align: center;">↑ Interchangeable ↓</p> <p style="text-align: center;"><b>NEW PARTS</b></p> <ul style="list-style-type: none"> <li>Transmission upper case</li> <li>Driven gear case</li> <li>Driven gear</li> <li>Speedometer cable</li> <li>Oil seal</li> </ul>		
	NOTE: Don't use old case from old new vehicle.						

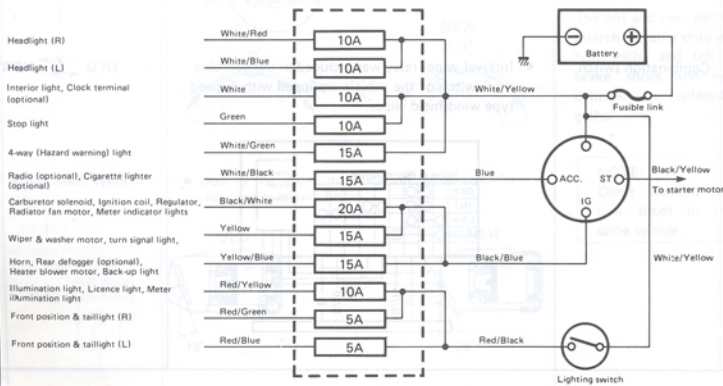
	PARTS	MODIFICATION	INTERCHANGEABILITY
TRANSMISSION	 <p>Speedometer cable</p> <p>Speedometer driven gear case</p> <p>Speedometer driven gear</p> <p>Transmission upper case</p>	 <p>OLD</p> <p>NEW</p> <p>Speedometer cable (modified)</p> <p>Speedometer driven gear case (modified)</p> <p>Oil seal (added)</p> <p>Speedometer driven gear (modified)</p> <p>Transmission upper case (modified)</p>	
STEERING	<p>Steering wheel</p>	<ul style="list-style-type: none"> <li>Steering wheel reshaped and horn buttons mounted on spoke.</li> </ul>  <p>OLD</p> <p>Horn button</p> <p>NEW</p> <p>Horn button</p>	<p>OLD <del>↔</del> NEW</p>
BRAKE	<p>Front brake shoe</p> <p>Front wheel cylinder</p>	<ul style="list-style-type: none"> <li>Brake shoe lining length was longer and its surface area was wider.</li> </ul>  <p>OLD</p> <p>100°</p> <p>NEW</p> <p>111°</p> <ul style="list-style-type: none"> <li>Due to the above modification, wheel cylinders reshaped as shown below.</li> </ul>  <p>OLD</p> <p>18°</p> <p>NEW</p> <p>28°</p>	<p>OLD ↔ NEW</p> <p>The old and new parts are interchangeable only when both right and left side brake shoes and wheel cylinders are replaced together.</p> <div style="border: 1px solid black; padding: 5px; margin-top: 10px;"> <p><b>NOTE:</b> Don't use old and new shoes in the same vehicle.</p> </div>










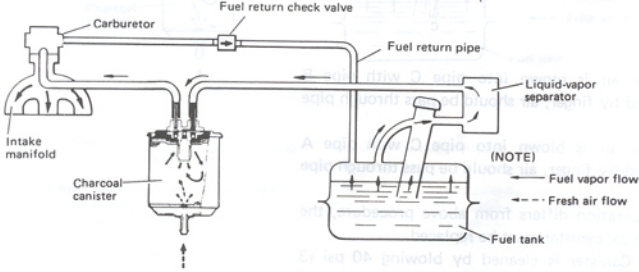
	PARTS	MODIFICATION	INTERCHANGEABILITY				
BRAKE	Parking brake shoe lever Parking brake cable	<ul style="list-style-type: none"> <li>The parking brake shoe lever and parking brake cable were reshaped where they joint each other as shown below.</li> </ul> 	OLD  NEW  OLD  NEW				
	ELECTRICAL	Headlight	<ul style="list-style-type: none"> <li>The shape was changed from round to square type and its wattage was also changed as given below.</li> </ul> <table border="1" data-bbox="357 502 523 560"> <thead> <tr> <th>OLD</th> <th>NEW</th> </tr> </thead> <tbody> <tr> <td>50/40W</td> <td>65/55W</td> </tr> </tbody> </table> 	OLD	NEW	50/40W	65/55W
OLD		NEW					
50/40W		65/55W					
Side turn signal light		<ul style="list-style-type: none"> <li>Installation changed from screwed type to inlaid (one touch fit) type.</li> </ul> 	OLD  NEW				
Ignition switch	<ul style="list-style-type: none"> <li>"ACC" position was added to ignition switch.</li> </ul> 	OLD  NEW					
Combination switch	<ul style="list-style-type: none"> <li>Interval wiper relay was included in the combination switch of the vehicle equipped with 3-speed type windshield wiper.</li> </ul> 	OLD  NEW					



PARTS	MODIFICATION	INTERCHANGEABILITY
Main fuse	<ul style="list-style-type: none"> <li>Changed to fusible link (0.5 mm<sup>2</sup>) type.</li> </ul> 	OLD  NEW
Fuse box	<ul style="list-style-type: none"> <li>Fuse is changed to blade type.</li> </ul> 	OLD  NEW
Wiring harness (New wiring diagram attached at the end of this bulletin)	<ul style="list-style-type: none"> <li>Fuse related circuits modified.</li> </ul>	OLD  NEW

The new fuses were wired as follows.



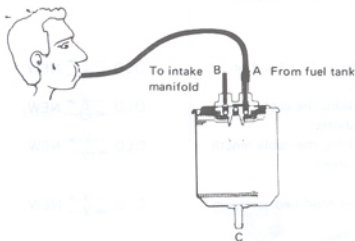
PARTS		MODIFICATION	INTERCHANGEABILITY
CAR HEATER	Car heater control lever	<ul style="list-style-type: none"> <li>Car heater control levers was rearranged as shown below.</li> </ul> <p>OLD</p>  <p>NEW</p> 	<p>OLD  NEW</p>
	Water valve cable	<ul style="list-style-type: none"> <li>Due to the above modification, the direction of bent cable end was changed.</li> </ul>	<p>OLD  NEW</p>
	Air control cable	<ul style="list-style-type: none"> <li>Due to the above modification, the cable length was made 60 mm (2.36 in) shorter.</li> </ul>	<p>OLD  NEW</p>
	Fresh air control cable	<ul style="list-style-type: none"> <li>Due to the above modification, the cable length was made 30 mm (1.18 in) longer.</li> </ul>	<p>OLD  NEW</p>
Heater fan switch	<ul style="list-style-type: none"> <li>The shape and structure were modified as shown below.</li> </ul> <p>OLD</p> <p>Turns ON with knob pulled</p>  <p>NEW</p> <p>Turns ON with knob turned</p> 	<p>OLD  NEW</p>	
FUEL	Charcoal canister	<ul style="list-style-type: none"> <li>Charcoal canister is added in the fuel evaporative emission control system and the piping is as shown below.</li> </ul>	
	Check valve	<ul style="list-style-type: none"> <li>Check valve is added to the fuel return pipe.</li> </ul>	
 <p>(NOTE)</p> <p>— Fuel vapor flow</p> <p>- - - Fresh air flow</p>			

## MAINTENANCE SERVICE

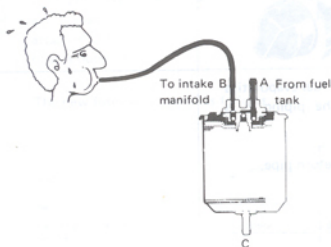
### Charcoal canister

When inspecting the charcoal canister, carry out in accordance with the following procedure.

1. Remove the charcoal canister.
2. When air is blown into pipe A, there should be no restriction of current through pipes B and C.



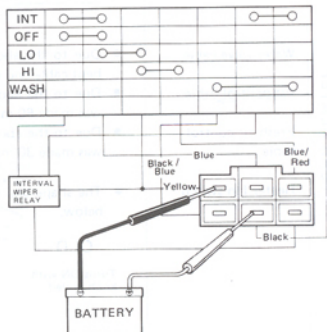
3. When air is blown into pipe B, air should not pass through either pipe A or C.



4. When air is blown into pipe C with pipe B closed by finger, air should pass through pipe A.
5. When air is blown into pipe C with pipe A closed by finger, air should pass through pipe B.
6. If operation differs from above procedure, the charcoal canister must be replaced.
7. The Canister is cleaned by blowing 40 psi (3 kg/cm<sup>2</sup>) of air into pipe A while sealing pipe B with a finger.

### Interval wiper relay test

1. Disconnect the wiper switch couplers.
  2. Turn the wiper switch to the "INT" position.
  3. Connect ⊕ cord and ⊖ cord of 12V battery to the coupler terminals as shown in the illustration.
- If an operating sound at the contact point of the relay is heard, the relay is at work properly.

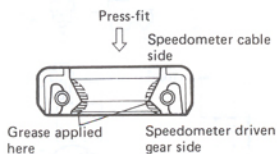


## PRECAUTIONS ON INSTALLATION

### Speedometer driven gear oil seal

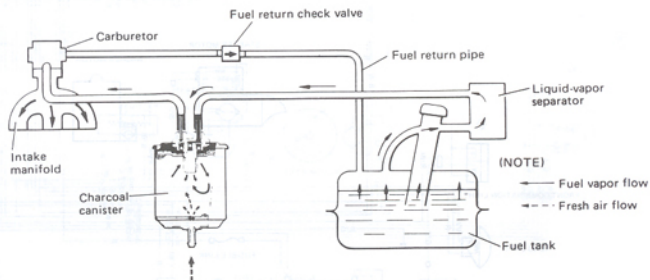
When installing the speedometer driven gear oil seal to the speedometer driven gear case, carry out in accordance with following procedures.

1. Apply SUZUKI SUPER GREASE C (Parts No. 99000-25030) to the oil seal lip as shown in the below figure.
2. Be sure to install the oil seal in such a direction as illustrated below.

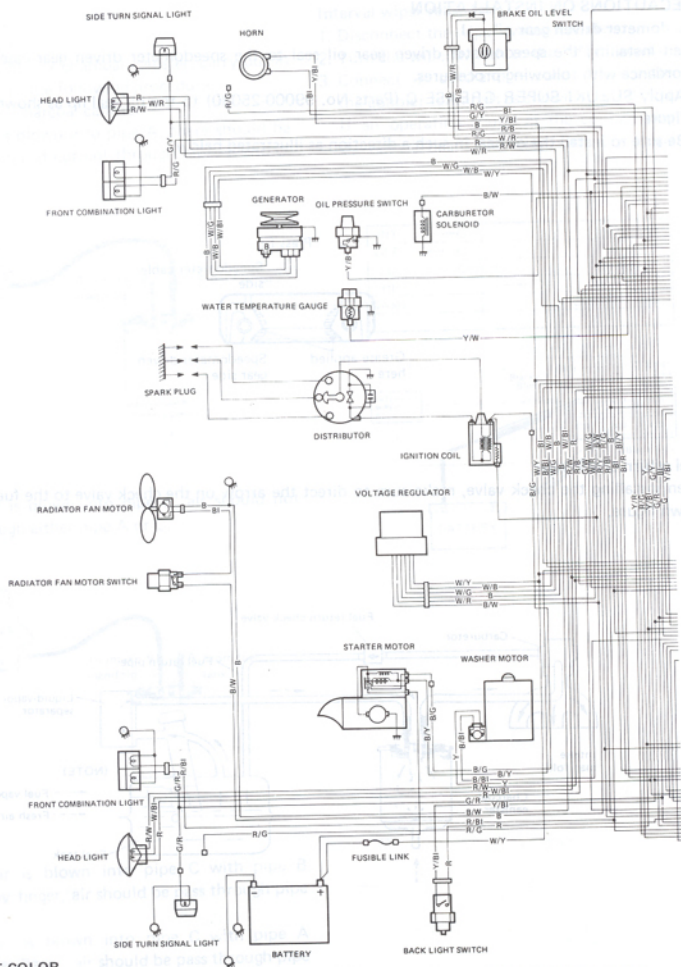


### Fuel return check valve

When installing the check valve, make sure to direct the arrow on the check valve to the fuel tank side as shown figure.



# WIRING DIAGRAM

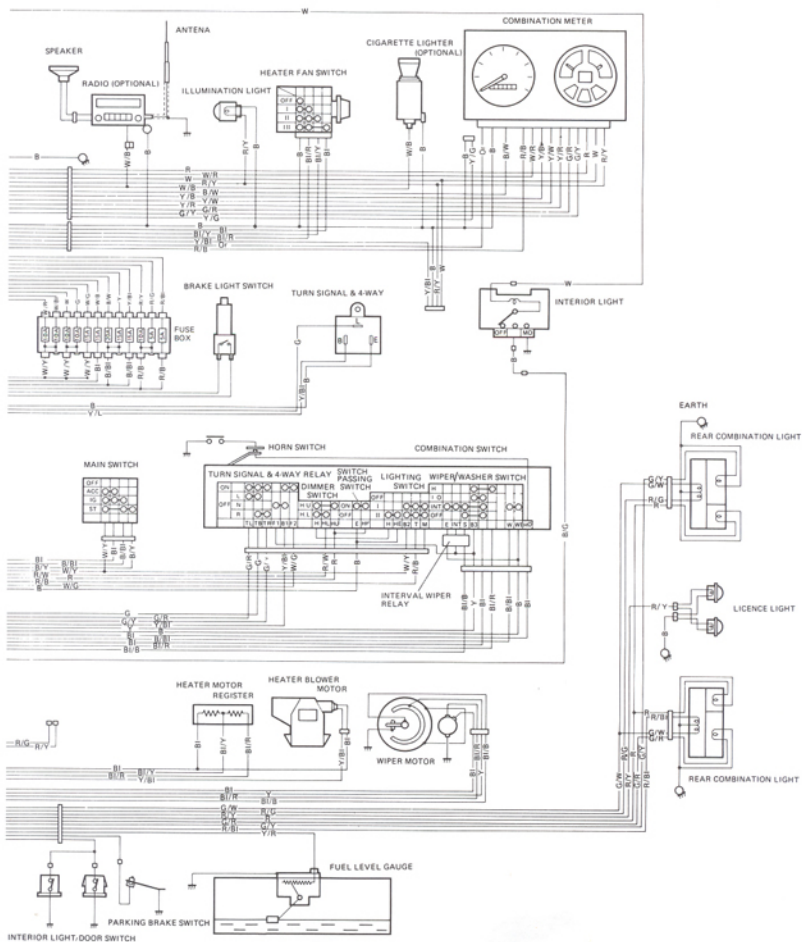


## WIRE COLOR

B	.....	Black
BI	.....	Blue
G	.....	Green
Or	.....	Orange
R	.....	Red
W	.....	White
Y	.....	Yellow
B/Bl	.....	Black with Blue tracer

B/G	.....	Black with Green tracer
B/W	.....	Black with White tracer
BI/B	.....	Blue with Black tracer
BI/R	.....	Blue with Red tracer
BI/W	.....	Blue with White tracer
G/B	.....	Green with Black tracer
G/R	.....	Green with Red tracer
G/W	.....	Green with White tracer





G/Y ..... Green with Yellow tracer  
 R/B ..... Red with Black tracer  
 R/Bl ..... Red with Blue tracer  
 R/G ..... Red with Green tracer  
 R/W ..... Red with White tracer  
 R/Y ..... Red with Yellow tracer  
 W/B ..... White with Black tracer  
 W/Bl ..... White with Blue tracer

W/G ..... White with Green tracer  
 W/R ..... White with Red tracer  
 W/Y ..... White with Yellow tracer  
 Y/B ..... Yellow with Black tracer  
 Y/Bl ..... Yellow with Blue tracer  
 Y/G ..... Yellow with Green tracer  
 Y/R ..... Yellow with Red tracer  
 Y/W ..... Yellow with White tracer